

*Legendary*

**AUTO INTERIORS LTD.**

THE FINEST COLLECTION OF INTERIOR AND EXTERIOR PRODUCTS

**2024**  
FIRST  
QUARTER



**CHRYSLER  
DODGE  
PLYMOUTH**

**63-76 A-BODY, 70-74 E-BODY  
& 64-79 TRUCK**



[www.legendaryautointeriors.com](http://www.legendaryautointeriors.com)



# INTRODUCING THE BEST WARRANTY COVERAGE IN THE INDUSTRY!!

## Limited Lifetime Warranty

**Limited Warranty** - Legendary Auto Interiors Ltd. (called "we") warrants that the products it manufactures will be free of defects in materials and workmanship from the date it is first purchased by the retail purchaser. A retail purchaser is any person or any entity who or which purchases the product but does not do so for resale.

**Obligation** - If a product is not as warranted, we will either repair or, at our option, replace the defective product. If repair or replacement is not possible within a reasonable time, we will refund the purchase price.

**Exclusions from Warranty** - This Warranty does not apply to:

1. Conditions resulting from the product being altered, abused, misused, damaged by accident or negligence; being repaired without our authorization; or not being maintained properly in accordance with written instructions provided with the product.
2. Conditions resulting from ordinary wear and tear or including, without limitation, exposure to ultraviolet light.
3. Conditions resulting from the use of Specialty Run Materials (SRM) supplied by the purchaser.
4. Conditions resulting from improper installation by the purchaser or anyone else outside of our control.

**Disclaimer** - EXCEPT FOR THE LIMITED WARRANTY DESCRIBED ABOVE, WE OFFER NO WARRANTIES, EXPRESSED OR IMPLIED, AND OTHER THAN THE LIMITED WARRANTY EXPRESSLY CONTAINED HEREIN, WE HEREBY DISCLAIM ANY AND ALL WARRANTIES, INCLUDING WITHOUT LIMITATION ANY IMPLIED WARRANTIES OF MERCHANTABILITY, SUITABILITY OR FITNESS FOR A PARTICULAR PURPOSE. Some states do not allow limitations on how long an implied warranty lasts, so the above limitation may not apply to you.

**Exclusion of Incidental and Consequential Damages** - WE ARE NOT RESPONSIBLE FOR ANY INCIDENTAL OR CONSEQUENTIAL DAMAGES RESULTING FROM BREACH OF THE LIMITED WARRANTY DESCRIBED ABOVE. Some states do not allow the exclusion or limitation of incidental or consequential damages, so the above limitation or exclusion may not apply to you.

**Other Legal Rights** - This Warranty gives you specific legal rights, and you may also have other rights which vary from state to state.

**What To Do If You Have A Warranty Claim** - If you have a warranty claim, you must call our sales office for further assistance. Once given a return authorization number please indicate the number on the box and return the product to our facility; Legendary Auto Interiors 121 West Shore Blvd, Newark, NY 14513. We will perform our warranty obligation within a reasonable amount of time after the returned product arrives at our facility.



**PRODUCT DISCLAIMER:** Products listed in this catalog have been reproduced and/or remanufactured to resemble original products. All manufacturers names and descriptions are used for reference purposes only. It is therefore understood that the products listed in this catalog are in fact REPRODUCTIONS unless specified otherwise. All parts described and offered for sale in this publication as NOS (New Old Stock) are new parts/materials manufactured by or for Chrysler Group LLC and General Motors Corporation.

LEGENDARY AUTO INTERIORS LTD., COPYRIGHT 2022

All literature produced by and directly related to Legendary Auto Interiors Ltd., is protected under copyright laws.  
All literature cannot be reproduced for any reason unless prior permission is obtained.

# Vinyl Yardage

The following grains are available off the roll and come in 1/2 yard increments ONLY

<b>Ascot</b> VVYDASCOT(C) (1 Yard).....\$64.00/yd.  VV1/2YDASCOT(C) (1/2 Yard).....\$32.00/ea. <i>Available colors: 100</i>	<b>Madrid</b> VVYDMADRID(C) (1 Yard).....\$64.00/yd.  VV1/2YDMADRID(C) (1/2 Yard).....\$32.00/ea. <i>Available colors: 100G, 202G, 204G, 210G, 220G, 230G, 235G, 239G, 240G, 310G, 325G, 331G, 333G, 334G, 338G, 342G, 343G, 351G, 369G, 380G, 415G, 420G, 421G, 424G, 429G, 448G, 460G, 465G, 469G, 501G, 511G, 513G, 520G, 631G, 635G, 640G, 642G, 645G, 650G, 651G, 657G, 658G, 670G, 679G, 683G, 690G, 694G, 695G, 697G, 709G, 710G</i>
<b>Bison</b> VVYDBISON(C) (1 Yard).....\$64.00/yd.  VV1/2YDBISON(C) (1/2 Yard).....\$32.00/ea. <i>Available colors: 100, 204, 314, 510, 606, 610</i>	<b>Oxen</b> VVYDOXEN(C) (1 Yard).....\$64.00/yd.  VV1/2YDOXEN(C) (1/2 Yard).....\$32.00/ea. <i>Available colors: 100</i>
<b>Coachman</b> VVYDCOACHMAN(C) (1 Yard).....\$64.00/yd.  VV1/2YDCOACHMAN(C) (1/2 Yard).....\$32.00/ea. <i>Available colors: 100, 130, 140, 200, 330, 338, 340, 432, 434, 452, 528, 540, 550, 560, 640, 650, 656, 664, 666, 670</i>	<b>Oxford</b> VVYDOXFORD(C) (1 Yard).....\$64.00/yd.  VV1/2YDOXFORD(C) (1/2 Yard).....\$32.00/ea. <i>Available colors: 100, 200, 264, 360, 450</i>
<b>Cologne</b> VVYDCOLOGNE(C) (1 Yard).....\$64.00/yd.  VV1/2YDCOLOGNE(C) (1/2 Yard).....\$32.00/ea. <i>Available colors: 100, 102, 10A, 202, 318, 320, 332, 414, 420, 430, 520, 526, 614, 620, 636</i>	<b>Ranger</b> VVYDRANGER(C) (1 Yard).....\$64.00/yd.  VV1/2YDRANGER(C) (1/2 Yard).....\$32.00/ea. <i>Available colors: 100, 200</i>
<b>Doeskin</b> VVYDDOESKIN(C) (1 Yard).....\$64.00/yd.  VV1/2YDDOESKIN(C) (1/2 Yard).....\$32.00/ea. <i>Available colors: 100, 104, 200, 206G, 508G</i>	<b>Shallow Elk</b> VVYDSHALLOWELK(C) (1 Yard).....\$64.00/yd.  VV1/2YDSHALLOWELK(C) (1/2 Yard).....\$32.00/ea. <i>Available colors: 100, 156, 200, 202G, 230G, 341</i>
<b>Dorchester</b> VVYDDORCHESTER(C) (1 Yard).....\$64.00/yd.  VV1/2YDDORCHESTER(C) (1/2 Yard).....\$32.00/ea. <i>Available colors: 100, 202</i>	<b>Sierra</b> VVYDSIERRA(C) (1 Yard).....\$64.00/yd.  VV1/2YDSIERRA(C) (1/2 Yard).....\$32.00/ea. <i>Available colors: 100G, 102G, 200G, 209G, 319G, 528G, 684G, 688G</i>
<b>El Paso</b> VVYDELPASO(C) (1 Yard).....\$64.00/yd.  VV1/2YDELPASO(C) (1/2 Yard).....\$32.00/ea. <i>Available colors: 100, 200</i>	
<b>Krinkle</b> VVYDKRINKLE(C) (1 Yard).....\$64.00/yd.  VV1/2YDKRINKLE(C) (1/2 Yard).....\$32.00/ea. <i>Available colors: 100, 154</i>	

1 YARD AND MORE IS SHIPPED OVERSIZED 1

## Specialty Grain Vinyl Yardage

All grain/color combinations not listed above can be produced upon request.  
Available in 1/2 yd or 1yd sheets ONLY

1/2 Yard (54"x18")  
 TTMOLDSMALL.....\$36.00/ea.  
 \* Need to specify grain and color

1 Yard (54"x36")  
 TTMOLDXL.....\$96.00/ea.   
 \* Need to specify grain and color



# UPHOLSTERY AND TRIM ACCESORIES

 [facebook.com/legendaryautointeriors](https://facebook.com/legendaryautointeriors)

 [twitter.com/legendaryautoin](https://twitter.com/legendaryautoin)

 [www.legendaryautointeriors.com](http://www.legendaryautointeriors.com)

 [instagram.com/legendaryautointeriorsltd](https://instagram.com/legendaryautointeriorsltd)

 [youtube.com/user/legendaryauto](https://youtube.com/user/legendaryauto)

# Chrysler, Dodge, Plymouth

## 1963 DART GT

This Legendary product features as-original Bison grain inserts and Bison grain skirts

**(C) COLOR CODES:**

- (206) - Taupe [Trim Code 893]
- (302) - Blue [Trim Code 891]
- (406) - Turquoise [Trim Code 898]
- (510) - Red [Trim Code 895]

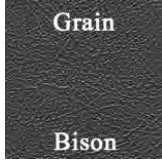

- Front Buckets ..... **AA63CL00010(C)**  
(All colors)..... \$709/pr.  
\* Please specify carpet color of stretch panel at time of order.  
\* Molded foam is available for this model. See the "Molded Foam" section in this catalog.
- Hardtop Rear Bench..... **AA63CL00040(C)**  
Convertible Rear Bench ..... **AA63CL00050(C)**  
(All colors)..... \$488/ea.
- Front Bucket Seatback Panels ..... **SK63CL00018(C)**  
(Pre-sewn vinyl and carpet panels with new boards)  
(All colors)..... \$204/pr.  
\*Please specify carpet color at time of order.

## 1964 VALIANT SIGNET

This Legendary product features as-original 1/16 Rib grain inserts with chrome accent band, silver tinsel accent welt and Bison grain skirts.

**(C) COLOR CODES:**

- (101) - Black (100) with Silver Tinsel welt [Trim Code P4X]
- (300) - Dark Blue (308) / Light Blue (314)  
with Silver Tinsel welt [Trim Code P4B]
- (502) - Dark Red (504) / Crimson Red (510)  
with Silver Tinsel welt [Trim Code P4R]
- (658) - Dark Brown (608) / Fawn Tan (610)  
with Silver Tinsel welt [Trim Code P4T]



- Front Buckets ..... **AA64CV00010(C)**  
101, 300, 502.....\$709/pr.  
658.....\$1109/pr. (L1)  
\* Please specify carpet color of stretch panel at time of order.  
\* Molded foam is available for this model. See the "Molded Foam" section in this catalog.
- Hardtop Rear Bench..... **AA64CV00040(C)**  
101, 300, 502.....\$565/ea.  
658.....\$989/ea. (L1)  
Convertible Rear Bench ..... **AA64CV00050(C)**  
101, 300, 502.....\$565/ea.  
658.....\$989/ea. (L1)
- Front Bucket Seatback Panels ..... **SK64CV00018(C)**  
(Pre-sewn vinyl with new boards)  
101, 300, 502.....\$193/pr.  
658.....\$310/pr. (L1)  
409.....\$364/pr. (L1)
- Convertible Rear Seatback Panels..... **SK64CLV00019(C)**  
100, 314, 410, 510, 610.....\$79/pr.

## 1964 DART GT

This Legendary product features as-original heat sealed Bison grain inserts with heat sealed chrome emblem and Bison grain skirts.

**(C) COLOR CODES:**

- (101) - Black (100) with Silver Tinsel welt [Trim Code P4X]
- (300) - Dark Blue (308) / Light Blue (314) with Silver Tinsel welt [Trim Code P4B]
- (409) - Dark Olive Gold (408) / Light Olive Gold (410)  
with Silver Tinsel welt [Trim Code P4Y]
- (509) - Crimson Red (510) with Silver Tinsel welt [Trim Code P4R]
- (658) - Dark Brown (608) / Fawn Tan (610) with Silver Tinsel welt [Trim Code P4T]

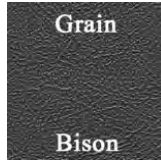

- Front Buckets ..... **AA64CL00010(C)**  
100xx, 101xx, 300xx, 509xx.....\$725/pr.  
658xx.....\$1057/pr. (L1)  
409xx.....\$1283/pr. (L1)  
\* Please specify silver tinsel or color of vinyl cordwelt around seat and back panel inserts at time of order.  
\* Please specify carpet color of stretch panel at time of order.  
\* Molded foam is available for this model. See the "Molded Foam" section in this catalog.
- Hardtop Rear Bench..... **AA64CL00040(C)**  
Convertible Rear Bench ..... **AA64CL00050(C)**  
100, 101, 300, 509.....\$673/ea.  
658.....\$989/ea. (L1)  
409.....\$1283/ea. (L1)
- Front Bucket Seatback Panels <sup>OS1</sup>..... **SK64CL00018(C)**  
(Pre-sewn vinyl panels with new boards)  
100, 300, 509.....\$193/pr.  
658.....\$310/pr. (L1)  
409.....\$364/pr. (L1)
- Convertible Rear Seatback Panels..... **SK64CLV0019(C)**  
100, 314, 410, 510, 610.....\$79/pr.



### 1965 DART GT

This Legendary product features as-original heat sealed Cologne grain inserts with Bison grain skirts.

**(C) COLOR CODES:**

- (100) - Black [Trim Code P4X]
- (202) - Pearl White [Trim Code P4Y]
- (314) - Blue [Trim Code P4B]
- (520) - Red [Trim Code P4R]
- (610) - Fawn Tan [Trim Code P4T]

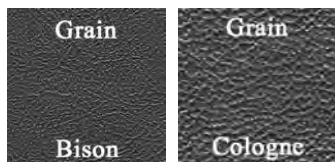

Front Buckets ..... **AA65CL00010(C)**  
 (All colors) ..... \$709/pr.  
 ⚠ Metal emblems not included.  
 ⚠ Please specify carpet color of stretch panel at time of order.  
 ⚠ Molded foam is available for this model. Please see the "Molded Foam" section in this catalog.

Hardtop Rear Bench ..... **AA65CL00040(C)**  
 Convertible Rear Bench ..... **AA65CL00050(C)**  
 (All colors) ..... \$539/ea.

Front Bucket Seatback Panels ..... **SK65CL00018(C)**   
 (Pre-sewn vinyl and carpet panels with new boards)  
 (All colors) ..... \$204/pr.  
 ⚠ Please refer to carpet color selection to specify carpet color at time of order.

Convertible Rear Seatback Panels ..... **SK64CLV00019(C)**  
 (All colors) ..... \$79/pr.

### 1965 VALIANT SIGNET

This Legendary product features as-original heat sealed Bison grain inserts with Bison grain skirts.

**(C) COLOR CODES:**

- (100) - Black [Trim Code P4X]
- (314) - Blue [Trim Code P4B]
- (510) - Crimson Red [Trim Code P4R]
- (614) - Gold [Trim Code P4Y]

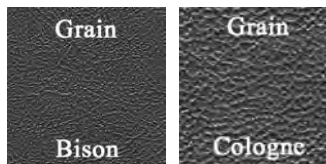

Front Buckets ..... **AA64CBV0010(C)**  
 (All colors) ..... \$709/pr.  
 ⚠ Please specify carpet color of stretch panel at time of order.  
 ⚠ Molded foam is available for this model. Please see the "Molded Foam" section in this catalog.

Hardtop Rear Bench ..... **AA65CV00040(C)**  
 Convertible Rear Bench ..... **AA65CV00050(C)**  
 (All colors) ..... \$569/ea.

Front Bucket Seatback Panels ..... **SK65CBV0018(C)**   
 (Pre-sewn vinyl panels with new boards)  
 (All vinyl) ..... \$193/pr.  
 ⚠ Please refer to carpet color selection to specify carpet color at time of order.

Convertible Rear Seatback Panels ..... **SK64CLV00019(C)**  
 ..... \$79/pr.

### 1966 DART GT

This Legendary product features as-original Cologne grain inserts and Cologne grain skirts.

**(C) COLOR CODES:**

- (100) - Black [Trim Code P4X]
- (202) - Pearl White [Trim Code P4W]
- (318) - Blue [Trim Code P4B]
- (505) - Red [Trim Code P4H]
- (617) - Ginger (616) / Gold (614) [Trim Code P4T]

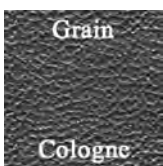

Front Buckets ..... **AA66CL00010(C)**  
 (All colors) ..... \$569/pr.  
 ⚠ Molded foam is available for this model. See the "Molded Foam" section in this catalog.

Hardtop Rear Bench ..... **AA66CL00040(C)**  
 Convertible Rear Bench ..... **AA66CL00050(C)**  
 (All colors) ..... \$394/ea.  
 ⚠ 617 Gold was N/A in convertible models.

Convertible Rear Seatback Panels ..... **SK64CLV00019(C)**   
 100, 202, 318, 505, 614  
 ..... \$79/pr.

### 1966 VALIANT SIGNET

This Legendary product features as-original Ostrich grain inserts with Cologne grain skirts.

**(C) COLOR CODES:**

- (100) - Black [Trim Code H5X]
- (372) - Dark Blue (322) / Light Blue (318) [Trim Code H5B]
- (505) - Red [Trim Code H5H]
- (661) - Light Gold (618) / Gold (614) [Trim Code H5T]

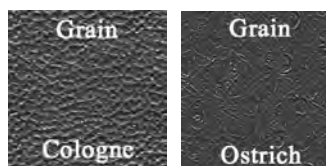

Front Buckets ..... **AA66CV00010(C)**  
 100, 372, 505 ..... \$569/pr.  
 661 ..... \$819/ea. (L1)  
 ⚠ Molded foam is available for this model. See the "Molded Foam" section in this catalog.

Hardtop Rear Bench ..... **AA66CV00040(C)**  
 Convertible Rear Bench ..... **AA66CV00050(C)**  
 100, 372, 505 ..... \$394/ea.  
 661 ..... \$633/ea. (L1)

Convertible Rear Seatback Panels ..... **SK64CLV00019(C)**   
 100, 202, 318, 505, 614  
 ..... \$79/pr.

## 1967 DART GT

This Legendary product features as-original heat sealed Cologne grain inserts with Cologne grain skirts.

### (C) COLOR CODES:

- (100) - Black [Trim Code P6X]
- (202) - Pearl White [Trim Codes P6W, P6C, P6V]
- \*P6W - Pearl White w/ Black Carpet
- \*P6C - Pearl White w/ Blue Carpet
- \*P6V - Pearl White w/ Red Carpet
- (320) - Navy [Trim Code P6B]
- (520) - Red [Trim Code P6R]
- (620) - Copper [Trim Code P6K]

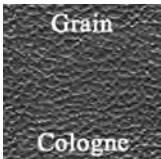

Front Buckets ..... **AA67CL00010(C)**  
 (All colors).....\$569/pr.  
 Metal emblems not included.  
 Molded foam is available for this model. See the "Molded Foam" section in this catalog.

Hardtop Rear Bench.....**AA67CL00040(C)**  
 Convertible Rear Bench ..**AA67CL00056(C)**  
 (All colors).....\$394/ea.

## 1968 DART GT & GTS

This Legendary product features as-original heat sealed Ascot grain inserts with K.V. grain pleat and Cologne grain skirts.

Front Buckets ..... **AA68CL00010(C)**  
 100, 202, 357, 430, 527.....\$679/pr.  
 637.....\$865/pr. (L1)  
 Metal emblems not included.  
 Molded foam is available for this model.

Front Bucket Seatback Panels .... **SK68AB00018(C)**  
 (New boards wrapped in vinyl with mounting hardware attached as original. Ready to install.)  
 (All colors).....\$175/pr.

Hardtop Rear Bench.....**AA68CL00040(C)**  
 Convertible Rear Bench .....**AA68CL00056(C)**  
 100, 202, 357, 430, 527.....\$470/ea.  
 637.....\$608/ea. (L1)  
 Metal emblem not included.

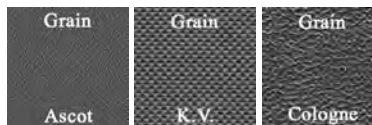

### (C) COLOR CODES:

- (100) - Black [Trim Codes P6X, S6X]
- (202) - Pearl White [Trim Codes P6W, P6C, P6D, P6E, S6W, S6C, S6D, S6E]
- \*P6W, S6W - Pearl White w/ Black Carpet
- \*P6C, S6C - Pearl White w/ Blue Carpet
- \*P6D, S6D - Pearl White w/ Green Carpet
- \*P6E, S6E - Pearl White w/ Gold Carpet
- (357) - Navy Blue Pleat (320) / Light Blue (332) [Trim Codes P6B, S6B]
- (430) - Green [Trim Codes P6F, S6F]
- (527) - Maroon Pleat (526) / Red (520) [Trim Codes P6R, S6R]
- (637) - Parchment Pleat (230) / Gold (636) [Trim Codes P6N, S6N]

\*\*\*GT Trim Codes - P6X, P6W, P6C, P6D, P6E, P6F, P6R, P6N  
 \*\*\*GTS Trim Codes - S6X, S6W, S6C, S6D, S6E, S6F, S6R, S6N

## 1968 DART GT & GTS "RALLYE SEAT"

This Legendary product features as-original heat sealed Ascot grain inserts with K.V. grain pleats and Cologne grain skirts.

### (C) COLOR CODES:

- (100) - Black
- (202) - Pearl White
- (357) - Navy Blue (320) / Light Blue (332)
- (430) - Green
- (527) - Maroon (526) / Red (520)
- (637) - Parchment (230) / Gold (636)



PHOTO N/A  
 AT TIME OF  
 PRINTING

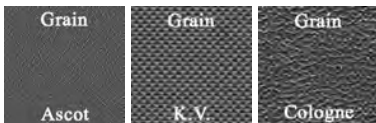

Front Buckets ..... **RS68CL00010(C)**   
 100, 202, 357, 430, 527.....\$1098/pr.  
 637.....\$1436/pr. (L1)

\*Metal emblems not included.  
 \*Kit consists of: (1) pair Rallye Bucket Seat Upholstery, (1) set Rallye Bucket Seat Foam, (4) Front Seat Top Spring to Frame Hold Back Listing, (1 yd) Muslin, (30 ft) Listing Wire, (2 yds) Burlap, (9 ft) 2 inch Felt and (1) Dust Mask.

Front Bucket Seatback Panels ..... **SK68AB00018(C)**  
 (New boards wrapped in vinyl with mounting hardware attached as original. Ready to install.)  
 (All colors).....\$175/pr.

Hardtop Rear Bench.....**AA68CL00040(C)**  
 Convertible Rear Bench .....**AA68CL00056(C)**  
 100, 202, 357, 430, 527.....\$470/ea.  
 637.....\$608/ea. (L1)  
 Metal emblem not included.

## 1969 DART GT & GTS

This Legendary product features as-original Dakota grain inserts with Dakota grain skirts.

### (C) COLOR CODES:

- (100) - Black [Trim Code P6X]
- (202) - Pearl White [Trim Codes P6W, P6C, P6E, P6F]
- \*P6W - Pearl White w/ Black Carpet
- \*P6C - Pearl White w/ Blue Carpet
- \*P6E - Pearl White w/ Gold Carpet
- \*P6F - Pearl White w/ Green Carpet
- (332) - Blue [Trim Code P6B]
- (432) - Green [Trim Code P6G]
- (507) - Red [Trim Code P6R]
- (630) - Gold [Trim Code P6Y]

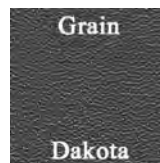

Front Buckets ..... **AA69CL00010(C)**  
 (All colors) .....\$574/pr.  
 Molded foam is available for this model. See the "Molded Foam" section in this catalog.

Front Bucket Seatback Panels ..... **SK69CL00018(C)**  
 (New boards wrapped in vinyl with mounting hardware attached as original. Ready to install.)  
 (All colors).....\$175/pr.

Hardtop Rear Bench.....**AA69CL00040(C)**  
 Convertible Rear Bench .....**AA69CL00056(C)**  
 (All colors).....\$403/ea.

### 1969 DART GT & GTS "RALLYE SEAT"

This Legendary product features as-original Dakota grain inserts with Dakota grain skirts.

**(C) COLOR CODES:**

- (100) - Black
- (202) - Pearl White
- (432) - Green
- (507) - Red
- (630) - Gold

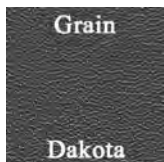

Front Buckets ..... **RS69CL00010(C)** <sup>052</sup>  
 (All colors) ..... \$971/pr.  
 \*Kit consists of: (1) pair Rallye Bucket Seat Upholstery, (1) set Rallye Bucket Seat Foam, (4) Front Seat Top Spring to Frame Hold Back Listing, (1 yd) Muslin, (30 ft) Listing Wire, (2 yds) Burlap, (9 ft) 2 inch Felt and (1) Dust Mask.

Front Bucket Seatback Panels ..... **SK69CL00018(C)**  
 (New boards wrapped in vinyl with mounting hardware attached as original. Ready to install.)  
 (All colors) ..... \$175/pr.

Hardtop Rear Bench ..... **AA69CL00040(C)**  
 Convertible Rear Bench ..... **AA69CL00056(C)**  
 (All colors) ..... \$403/ea.

### 1970 DART SWINGER & DART GT

This Legendary product features as-original Derma grain inserts and Coachman grain skirts.

**(C) COLOR CODES:**

- (100) - Black [Trim Code H6X9]
- (435) - Light Green (432) / Dark Green (434) [Trim Code H6F8]
- (656) - Brown [Trim Code H6T5]

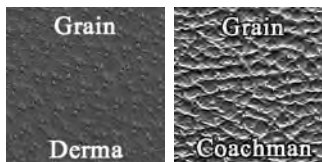

Front Buckets ..... **AA70CL00010(C)**  
 (All colors) ..... \$597/pr.

Rear Bench .....  
 Hardtop ..... **AA70CL00040(C)**  
 (All colors) ..... \$403/ea.

### 1971 DART SWINGER, DART GT & SCAMP

This Legendary product features as-original Shallow Elk grain inserts with Coachman grain skirts.

**(C) COLOR CODES:**

- (100) - Black [Trim Codes H6X9, D6X9]
  - (200) - White [Trim Codes H6XW, D6XW]
- \*\*\*Dart Swinger Trim Codes - H6X9, H6XW  
 \*\*\*Scamp Trim Codes - D6X9, D6XW

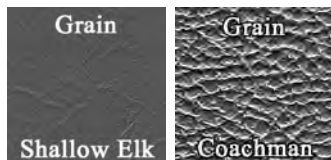

Front Buckets ..... **AA71CL00010(C)**  
 (All colors) ..... \$597/pr.  
 \*Metal emblems not included.

Rear Bench .....  
 Hardtop ..... **AA71CLD0048(C)**  
 (All colors) ..... \$403/ea.  
 \*Metal emblems not included.

### 1975-76 DART SWINGER & SCAMP

This Legendary product features as-original Shallow Elk grain inserts with Oxford grain skirts.

**(C) COLOR CODES:**

- (100) - Black [Trim Code C6X9]
- (200) - White [Trim Code C6XW]



Front Buckets ..... **AA75CLV0010(C)**  
 (All colors) ..... \$574/pr.  
 \*Molded foam is available for this model. See the "Molded Foam" section in this catalog.

Center Cushion/Armrest ..... **CR75CLV0013(C)**  
 (All colors) ..... \$104/ea.

Rear Bench ..... **AA74CLVD048(C)**  
 (All colors) ..... \$394/ea.



# Chrysler, Dodge, Plymouth

## 1966 DART 270

This Legendary product features as-original Cirrus grain inserts and Cologne grain skirts.

**(C) COLOR CODES:**

- (151) - Dark Gray (110) / Black (100) [Trim Code H4X]
- (211) - Opal (210) / Pearl White (202) [Trim Code H4W]
- (327) - Navy (320) / Light Blue (318) [Trim Code H4B]
- (532) - Red (528) / Crimson Red (505) [Trim Code H4H]
- (617) - Ginger (616) / Gold (614) [Trim Code H4T]

\*\*\*617 seats were made in ALL cologne grain (inserts & skirts)

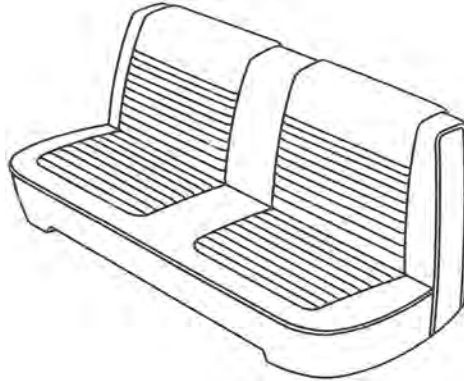
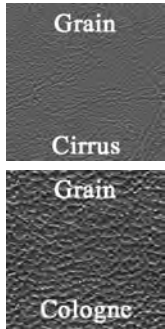

Front Split Bench.....	AA66CL00020(C)
(All colors).....	\$574/ea.
Convertible Rear Bench.....	AA66CL00060(C)
(All colors).....	\$403/ea.
Hardtop Rear Bench.....	AA66CL00080(C)
(All colors).....	\$403/ea.

## 1967 DART 270

This Legendary product features as-original Dorchester grain inserts with Cologne grain skirts.

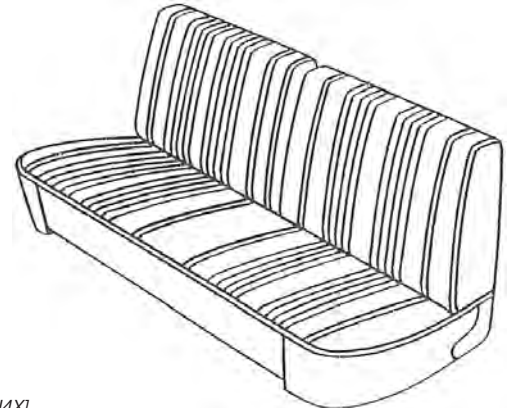

**(C) COLOR CODES:**

- (100) - Black [Trim Code H4X]
- (202) - Pearl White [Trim Codes H4W, H4C, H4V]
- \*H4W - Pearl White w/ Black Carpet
- \*H4C - Pearl White w/ Blue Carpet
- \*H4V - Pearl White w/ Red Carpet
- (327) - Navy (320) / Light Blue (318) [Trim Code H4B]
- (520) - Red [Trim Code H4R]
- (646) - Dark Tan (632) / Light Tan (618) [Trim Code H4T]

Front Split Bench.....	AA67CL00028(C)
100, 202, 327, 520.....	\$574/ea.
646.....	\$1237/ea. (L1)
Hardtop Rear Bench.....	AA67CL00080(C)
100, 202, 327, 520.....	\$403/ea.
646.....	\$1054/ea. (L1)

## 1967 DART GT

This Legendary product features as-original heat sealed Cologne grain inserts with Cologne grain skirts.

**(C) COLOR CODES:**

- (100) - Black [Trim Code P4X]
- (202) - Pearl White [Trim Code P4W, P4C, P4V]
- \*P4W - Pearl White w/ Black Carpet
- \*P4C - Pearl White w/ Blue Carpet
- \*P4V - Pearl White w/ Red Carpet
- (320) - Navy [Trim Code P4B]
- (520) - Red [Trim Code P4R]
- (620) - Copper [Trim Code P4K]

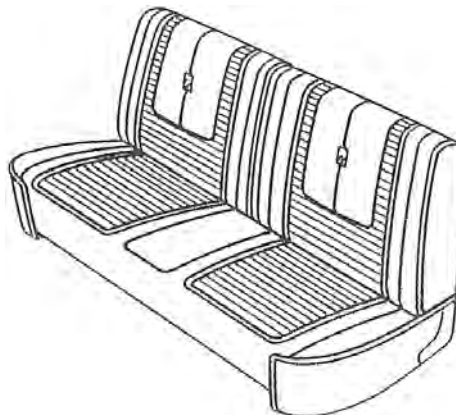
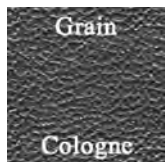

Convertible Front Split Bench.....	AA67CL00026(C)
(All colors).....	\$574/ea.
*Metal emblems <i>not</i> included.	
Convertible Rear Bench.....	AA67CL00056(C)
(All colors).....	\$394/ea.
*Metal emblems <i>not</i> included.	

## 1967 VALIANT 200 & SIGNET "CLOTH STYLE"

This Legendary product features as-original Cloth lower insert and Cologne grain top insert with Bambino grain accent & Cologne grain skirts.

**(C) COLOR CODES:**

- (972) - Blue Cloth (973) / Navy (320) [Trim Codes H1B, L1B]
- \*Features Light Blue (318) Accent Strip
- (974) - Turquoise Cloth (975) / Dark Turquoise (414) [Trim Codes H1Q, L1Q]
- \*Features Light Turquoise (418) Accent Strip
- (976) - Red Cloth (977) / Red (520) [Trim Codes H1R, L1R]
- (978) - Brown Cloth (979) / Dark Brown (622) [Trim Codes H1T, L1T]
- \*Features Light Tan (618) Accent Strip
- (980) - Black Cloth (981) / Black (100) [Trim Codes H1X, L1X]

\*\*\*Signet Trim Codes - H1B, H1Q, H1R, H1T, H1X  
 \*\*\*Valiant 200 Trim Codes - L1B, L1Q, L1R, L1T, L1X

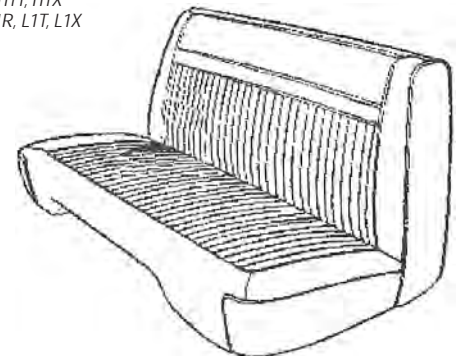

Front Split Bench (Sedan only).....	AA67CVC0020(C)
972, 974, 976, 980.....	\$1057/ea. (L1)
978.....	\$1507/ea. (L1)
Rear Bench (Sedan only).....	AA67CVC0080(C)
972, 974, 976, 980.....	\$854/ea. (L1)
978.....	\$1345/ea. (L1)



### 1968 DART & VALIANT 100

This Legendary product features as-original Double Stitch Rib grain inserts with Cologne grain skirts.

**(C) COLOR CODES:**

- (100) - Black [Trim Code L4X]
- (359) - Dark Blue (330) / Light Blue (332) [Trim Code L4B]
- (652) - Dark Tan (632) / Light Tan (634) [Trim Code L4T]



Front Split Bench .....	<b>AA68CLV0020(C)</b>
100, 359.....	\$574/ea.
652.....	\$901/ea. (L1)
Headrest Covers.....	<b>HC68CLMRW14(C)</b>
(Optional headrest covers for 1968 with zipper)	
100, 332, 634.....	\$110/pr.
Sedan Rear Bench (2 & 4 Door).....	<b>AA68CLV0081(C)</b>
100, 359.....	\$403/ea.
652.....	\$664/ea. (L1)

### 1968 DART GT & GTS

This Legendary product features as-original heat sealed Ascot grain inserts with K.V. grain pleats and Cologne grain skirts.

**(C) COLOR CODES:**

- (100) - Black [Trim Codes P4X, S4X]
- (202) - Pearl White [Trim Codes P4W, S4W]
- (357) - Navy Blue Pleat (320) / Light Blue (332) [Trim Codes P4B, S4B]
- (527) - Maroon Pleat (526) / Red (520) [Trim Codes P4R, S4R]

\*\*\*GT Trim Codes - P4X, P4W, P4B, P4R  
 \*\*\*GTS Trim Codes - S4X, S4W, S4B, S4R

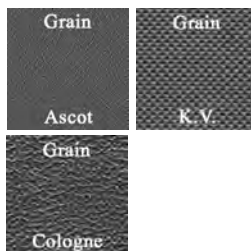

Front Split Bench (Convertible models only) .....	<b>AA68CL00026(C)</b>
(All colors).....	\$679/ea.
*Metal emblems <u>not</u> included.	
Headrest Covers.....	<b>HC68CLMRW14(C)</b>
(Optional headrest covers for 1968 with zipper)	
100, 202, 332, 520.....	\$110/pr.
Convertible Rear Bench .....	<b>AA68CL00056(C)</b>
(All colors).....	\$470/ea.
*Metal emblems <u>not</u> included.	

### 1969 DART SWINGER & VALIANT 100

This Legendary product features as-original Double Stitch Rib grain inserts with Coachman grain skirts.

**(C) COLOR CODES:**

- (152) Charcoal / Black [Trim Code L2X]
- (351) Light Blue (332) / Dark Blue (330) [Trim Code L2B]
- (650) Saddle [Trim Code L2T]



Front Split Bench .....	<b>AA69CLV0020(C)</b>
(All colors).....	\$574/ea.
Headrest Covers.....	<b>HC69CRW0014(C)</b>
100, 330, 650.....	\$110/pr.
Hardtop Rear Bench (Dart only).....	<b>AA69CLV0080(C)</b>
Sedan Rear Bench (Valiant only).....	<b>AA69CLV0081(C)</b>
(All colors).....	\$403/ea.
*Sedan rear bench will work for 2 and 4 door models	

### 1969 DART SWINGER

This Legendary product features as-original Ascot grain inserts with Coachman grain skirts.

**(C) COLOR CODES:**

- (100) - Black [Trim Code D2X]
- (351) - Light Blue (332) / Dark Blue (330) [Trim Code D2B]
- (650) - Saddle [Trim Code D2T]

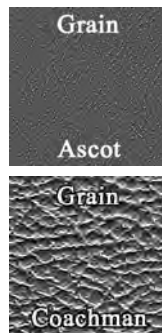

Front Split Bench .....	<b>AA69CL00028(C)</b>
(All colors).....	\$574/ea.
Headrest Covers.....	<b>HC69CRW0014(C)</b>
100, 330, 650.....	\$110/pr.
Hardtop Rear Bench.....	<b>AA69CL00080(C)</b>
(All colors).....	\$403/ea.

## 1969 DART CUSTOM

This Legendary product features as-original Ascot grain inserts with Coachman grain skirts.

### (C) COLOR CODES:

- (100) - Black [Trim Code H2X]
- (200) - White [Trim Codes H2W, H2C]
- \*H2W - White w/ Black Carpet
- \*H2C - White w/ Blue Carpet
- (359) - Dark Blue (330) / Light Blue (332) [Trim Code H2B]
- (437) - Dark Green (434) / Light Green (432) [Trim Code H2G]
- (528) - Red [Trim Code H2R]
- (650) - Saddle [Trim Code H2T]

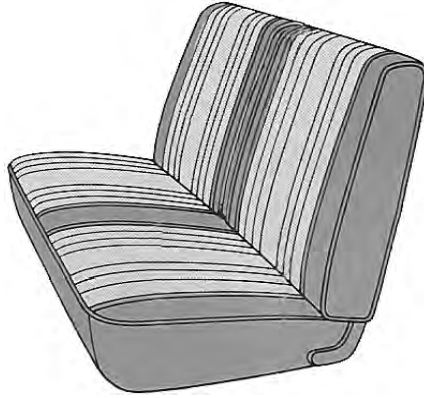
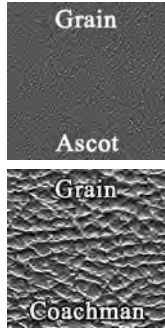

- Front Split Bench (Hardtop only) ..... **AA69CLU0028(C)**
- (All colors).....\$574/ea.
- Headrest Covers ..... **HC69CRW0014(C)**
- 100, 200, 332, 432, 528, 650.....\$110/pr.
- Rear Bench (Hardtop only)..... **AA69CLU0080(C)**
- (All colors).....\$403/ea.

## 1969 DART GT & DART GTS

This Legendary product features as-original Dakota grain inserts with Dakota grain skirts.

### (C) COLOR CODES:

- (100) - Black [Trim Code P2X]
- (202) - Pearl White [Trim Code P2W]
- (332) - Light Blue [Trim Code P2B]
- (507) - Red [Trim Code P2R]

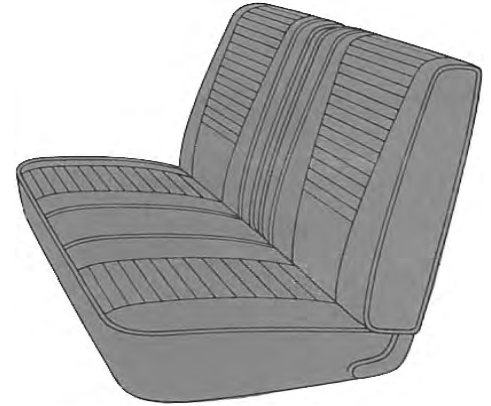
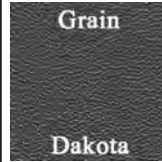

- Front Split Bench (Convertible only)..... **AA69CL00026(C)**
- (All colors).....\$574/ea.
- Headrest Covers..... **HC69CL00014(C)**
- (All colors).....\$110/pr.
- Convertible Rear Bench ..... **AA69CL00056(C)**
- (All colors).....\$403/ea.

## 1970 DART CUSTOM

This Legendary product features as-original Derma grain inserts with Coachman grain skirts.

### (C) COLOR CODES:

- (100) - Black [Trim Code H2X9]
- (200) - White [Trim Code H2XW]
- (351) - Light Blue (332) / Dark Blue (330) [Trim Code H2B7]
- (435) - Light Green (432) / Dark Green (434) [Trim Code H2F8]
- (656) - Brown [Trim Code H2T5]



- Front Split Bench ..... **AA70CLU0020(C)**
- (All colors).....\$574/ea.
- Hardtop Rear Bench ..... **AA70CL00040(C)**
- (All colors).....\$403/ea.

## 1970 DART SWINGER

This Legendary product features as-original Laredo grain inserts with Coachman grain skirts.

### (C) COLOR CODES:

- (100) - Black [Trim Code D2X9]
- (351) - Light Blue (332) / Dark Blue (330) [Trim Code D2B7]
- (435) - Light Green (432) / Dark Green (434) [Trim Code D2F8]
- (656) - Brown [Trim Code D2T5]



- Front Split Bench ..... **AA70CL00020(C)**
- (All colors).....\$574/ea.
- Hardtop Rear Bench..... **AA70CL00080(C)**
- (All colors).....\$403/ea.



### 1970 DART SWINGER

This Legendary product features as-original 3/5 Rib grain inserts with Coachman grain skirts.

**(C) COLOR CODES:**

- (100) Black [Trim Code L2X9]
- (351) Light Blue (332) / Dark Blue (330) [Trim Code L2B7]

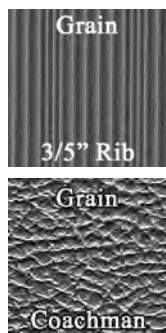

- Front Split Bench ..... **AA70CLV0020(C)**  
(All colors)..... \$574/ea.
- Hardtop Rear Bench..... **AA70CLV2080(C)**  
(All colors)..... \$403/ea.

### 1971 DART SWINGER & SCAMP

This Legendary product features as-original Shallow Elk grain inserts with Coachman grain skirts.

**(C) COLOR CODES:**

- (100) - Black [Trim Codes H2X9, D2X9]
- (200) - White [Trim Codes H2XW, D2XW]
- (359) - Dark Blue (330) / Light Blue (332) [Trim Codes H2B2, D2B2]
- (442) - Dark Green (452) / Light Green (432) [Trim Codes H2F3, D2F3]
- (666) - Ember Gold [Trim Codes H2Y3, D2Y3]

\*\*\*Dart Swinger & Dart Custom Trim Codes - H2X9, H2XW, H2B2, H2F3, H2Y3  
\*\*\*Scamp Trim Codes - D2X9, D2XW, D2B2, D2F3, D2Y3

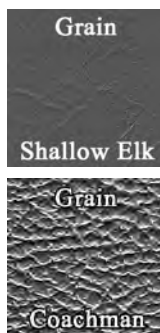

- Front Split Bench ..... **AA71CLD0020(C)**  
(All colors)..... \$574/ea.  
*\*Metal emblems not included.*
- Hardtop Rear Bench..... **AA71CLD0048(C)**  
(All colors)..... \$403/ea.  
*\*Metal emblems not included.*

### 1972 DART CUSTOM 4-DR & VALIANT 4-DR

This Legendary product features as-original Coachman grain inserts with Cologne grain skirts.

**(C) COLOR CODES:**

- (100) - Black [Trim Codes F4X9, C4X9]
- (340) - Bright Blue [Trim Codes F4B5, C4B5]
- (444) - Dark Green [Trim Codes F4F6, C4F6]
- (666) - Ember Gold [Trim Codes F4Y3, C4Y3]

\*\*\*Dart Custom Trim Codes - F4X9, F4B5, F4F6, F4Y3  
\*\*\*Valiant Trim Codes - C4X9, C4B5, C4F6, C4Y3



- Front Split Bench with Center Armrest (Sedan only) .... **AA72CLV0030(C)**  
(All colors)..... \$597/ea.  
*\*Metal emblems not included.*
- 4-Door Sedan Rear Bench ..... **Currently N/A**

### 1972 DART SWINGER & SCAMP "CLOTH STYLE"

This Legendary product features as-original Diamond Cloth inserts with Cologne grain skirts.

**(C) COLOR CODES:**

- (878) - Black & White Diamond Cloth (877) / Black (100) [Trim Code F3X9]
- (880) - Black & Blue Diamond Cloth (879) / Bright Blue (340) [Trim Code F3B5]
- (882) - Black & Green Diamond Cloth (881) / Dark Green (444) [Trim Code F3F6]



- Front Split Bench with Center Armrest ..... **AA72CLVC030(C)**  
(All colors)..... \$1035/ea. (L1)  
*\*Metal emblems not included.*
- Hardtop Rear Bench..... **AA72CLVC048(C)**  
(All colors)..... \$803/ea. (L1)  
*\*Metal emblems not included.*

# Chrysler, Dodge, Plymouth

## 1972 DART SWINGER & SCAMP

This Legendary product features as-original Shallow Elk grain inserts with Coachman grain skirts.

### (C) COLOR CODES:

- (100) - Black [Trim Code E2X9]
- (340) - Bright Blue [Trim Code E2B5]
- (445) - Light Green (432) / Dark Green (444) [Trim Code E2F6]
- (666) - Ember Gold [Trim Code E2Y3]

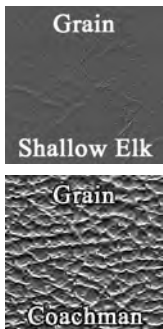

- Front Split Bench  
 (7" high headrest) ..... AA72CLV7020(C)  
 (9" high headrest) ..... AA72CLV9020(C)  
 (All colors) ..... \$574/ea.  
 \*Please specify 7" or 9" headrest at time of order.  
 \*Measure the integral headrest from the top center of the insert to the top center of the headrest.

- Hardtop Rear Bench ..... AA72CLV0080(C)  
 (All colors) ..... \$403/ea.

## 1972-73 DART SWINGER "CLOTH STYLE"

This Legendary product features as-original Plaid Cloth inserts with Coachman grain skirts.

### (C) COLOR CODES:

- (831) - Black & White Plaid Cloth (830) / Black (100) [Trim Codes B1X9, A1X9]
  - (838) - Blue Plaid Cloth (836) / Bright Blue (340) [Trim Codes B1B5, A1B5]
  - (839) - Yellow & Green Cloth (837) / Dark Green (444) [Trim Codes B1F6, A1F6]
- \*\*\*1972 Dart Swinger Trim Codes - B1X9, B1B5, B1F6  
 \*\*\*1973 Dart Swinger Trim Codes - A1X9, A1B5, A1F6



- Front Split Bench ..... AA72CLVC020(C)  
 831 ..... \$1031/ea. (L4)  
 838, 839 ..... \$1035/ea. (L1)

- Hardtop Rear Bench ..... AA72CLVC080(C)  
 831 ..... \$849/ea. (L4)  
 838, 839 ..... \$854/ea. (L1)

## 1973 DART SWINGER & SCAMP

This Legendary product features as-original Shallow Elk grain inserts with Coachman grain skirts.

### (C) COLOR CODES:

- (100) - Black [Trim Codes E2X9, D2X9]
  - (253) - Metallic Parchment (252) / Parchment (250) [Trim Codes E2L3, D2L3]
  - (352) - Metallic Blue (341) / Bright Blue (340) [Trim Codes E2B5, D2B5]
  - (449) - Metallic Green (448) / Dark Green (444) [Trim Codes E2F6, D2F6]
  - (675) - Metallic Bronze (674) / Honey Gold (672) [Trim Codes E2Y4, D2Y4]
- \*\*\*Dart Swinger & Scamp Trim Codes - E2X9, E2L3, E2B5, E2F6, E2Y4  
 \*\*\*Dart Swinger "Special" Trim Codes - D2X9, D2L3, D2B5, D2F6, D2Y4

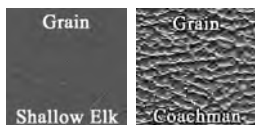

- Front Split Bench ..... AA73CLVS020(C)  
 100 ..... \$574/ea.  
 253 ..... \$954/ea. (L4)  
 449 ..... \$954/ea. (L1)  
 352 ..... \$558/ea. (L4)  
 675 ..... \$1349/ea. (L4)

- Hardtop Rear Bench ..... AA73CLVS080(C)  
 100 ..... \$403/ea.  
 253 ..... \$771/ea. (L4)  
 449 ..... \$771/ea. (L1)  
 352 ..... \$393/ea. (L4)  
 675 ..... \$1176/ea. (L4)

## 1973 DART SWINGER "CLOTH STYLE"

This Legendary product features as-original Geometric Cloth inserts with Coachman grain skirts.

### (C) COLOR CODES:

- (942) - Parchment Geometric Cloth (910) / Parchment (250) [Trim Codes F3L3]



- Front Split Bench with Center Armrest ..... AA73CLVDC30(C)  
 942 ..... \$1035/ea. (L1)

- Hardtop Rear Bench ..... AA73CLVDC80(C)  
 942 ..... \$828/ea. (L1)



### 1973 DART SWINGER, DART CUSTOM 4-DR & SCAMP

This Legendary product features as-original  
Shallow Elk grain inserts with Coachman grain skirts.

**(C) COLOR CODES:**

- (100) - Black [Trim Code F4X9]
- (253) - Metallic Parchment (252) / Parchment (250) [Trim Code F4L3]
- (352) - Metallic Blue (341) / Bright Blue (340) [Trim Code F4B5]
- (449) - Metallic Green (448) / Dark Green (444) [Trim Code F4F6]



Front Split Bench with Center Armrest ..... **AA73CLVD030(C)**  
 100..... \$597/ea.  
 253, 449..... \$978/ea. (L1)  
 352..... \$580/ea. (L4)

Hardtop Rear Bench..... **AA73CLVD048(C)**  
 100..... \$394/ea.  
 253, 449..... \$771/ea. (L1)  
 352..... \$382/ea. (L4)

\*Rear Bench not available for 4-Door Sedan models.

### 1974-75 DART SWINGER & SCAMP "CLOTH STYLE"

This Legendary product features as-original  
Cloth inserts with Oxford grain skirts.

**(C) COLOR CODES:**

- (943) - Black Cloth (911) / Black (100) [Trim Code F3X9] - 1974 only
- (944) - Parchment Cloth (912) / Parchment (264) [Trim Code F3L3] - 1974 only
- (946) - Green Cloth (913) / Jade Green (450) [Trim Code F3G6] - 1974 only
- (947) - Blue Cloth (914) / Lagoon Blue (360) [Trim Code F3B6] - 1974 only
- (948) - Black Cloth (915) / Black (100) [Trim Code C3X9] - 1975 only
- (949) - Gold Cloth (916) / Ember Gold (680) [Trim Code C3Y3] - 1975 only
- (953) - Green Cloth (917) / Jade Green (450) [Trim Code C3G6] - 1975 only
- (954) - Parchment Cloth (918) / Parchment (264) [Trim Code C3L3] - 1975 only



Front Split Bench with Center Armrest ..... **AA74CLVDC30(C)**  
 943, 946, 947, 948, 953..... \$1080/ea. (L1)  
 944, 949, 954..... \$1484/ea. (L1)

Rear Bench Hardtop (2-Door)..... **AA74CLVDC80(C)**  
 943, 946, 947, 948, 953..... \$854/ea. (L1)  
 944, 949, 954..... \$1236/ea. (L1)

### 1974-76 DART SWINGER & SCAMP

This Legendary product features as-original  
Shallow Elk grain inserts with Oxford grain skirts.

**(C) COLOR CODES:**

- (100) - Black [Trim Code E2X9] - 1974-1976
- (267) - Metallic Parchment (266) / Parchment (264) [Trim Code E2L3] - 1974-1976
- (348) - Light Blue (347) / Lagoon Blue (360) [Trim Code E2B6] - 1976 only
- (360) - Lagoon Blue [Trim Code E2B6] - 1974-1975
- (450) - Jade Green [Trim Code E2G6] - 1974-1975
- (453) - Light Green [Trim Code E2F6] - 1976 only
- (680) - Ember Gold [Trim Code E2Y3] - 1974 only
- (685) - Gold (679) / Ember Gold (680) [Trim Code E2Y3] - 1975-1976



Front Split Bench (1974)..... **AA74CLVS020(C)**  
 Front Split Bench (1975-76)..... **AA75CLVS020(C)**  
 100, 360, 450..... \$574/ea.  
 348..... \$1013/ea. (L1)  
 267, 453, 680, 685..... \$1349/ea. (L1)

Hardtop Rear Bench..... **AA74CLVS080(C)**  
 100, 360, 450..... \$403/ea.  
 348..... \$803/ea. (L1)  
 267, 453, 680, 685..... \$1176/ea. (L1)

### 1974-76 DART CUSTOM 4-DR & VALIANT 4-DR

This Legendary product features as-original  
Shallow Elk grain inserts with Oxford grain skirts.

**(C) COLOR CODES:**

- (100) - Black [Trim Codes F4X9, C4X9] - 1974-1975
- (267) - Metallic Parchment (266) / Parchment (264) [Trim Codes F4L3, C4L3] - 1974-1976
- (360) - Lagoon Blue [Trim Codes F4B6, C4B6] - 1974 only
- (450) - Jade Green [Trim Codes F4G6, C4G6] - 1974-1975
- (453) - Light Green [Trim Code C4F6] - 1976 only
- (685) - Gold (679) / Ember Gold (680) [Trim Code C4Y3] - 1975-1976

\*\*\*1974 Dart Custom Trim Codes - F4X9, F4L3, F4B6, F4G6  
 \*\*\*1975-1976 Dart Custom & 1974-1976 Valiant Trim Codes - C4X9, C4L3, C4B6, C4G6, C4F6, C4Y3



Front Split Bench with Center Armrest ..... **AA74CLVD030(C)**  
 100, 360, 450..... \$597/ea.  
 267, 453, 685..... \$1371/ea. (L1)

Rear Bench..... **Currently N/A**

\*Rear Bench not available for 4-Door Sedan models.

## 1970 DUSTER

This Legendary product features as-original Laredo grain inserts with Coachman grain skirts.

### (C) COLOR CODES:

**(100) - Black** [Not a factory option]

\*Black was not originally offered, but may be purchased as a special order. Available only as a prepaid, non-refundable and non-returnable order.

**(152) - Charcoal (154) / Black (100)** [Trim Code L6X9]

**(200) - White** [Trim Codes L6XW, L6BW, L6EW]

\*L6XW - White w/ Black Carpet

\*L6BW - White w/ Blue Carpet

\*L6EW - White w/ Red Carpet

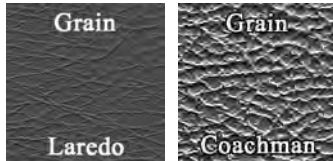

Front Buckets ..... **AA70CVD0010(C)**  
**(All colors)** ..... \$574/pr.

\*Metal emblems not included.

\*Molded foam is available for this model. See the "Molded Foam" section in this catalog.

Rear Bench ..... **AA70CVD0048(C)**  
**(All colors)** ..... \$403/ea.

\*Metal emblems not included.

## 1971 DUSTER & DEMON

This Legendary product features as-original El Paso grain inserts with Coachman grain skirts.

### (C) COLOR CODES:

**(155) - Charcoal (156) / Black (100)** [Trim Codes L6X9, M6X9]

**(560) - Bright Orange** [Trim Codes L6XV, M6XV]

\*\*\*Duster Trim Codes - L6X9, L6XV

\*\*\*Demon Trim Codes - M6X9, M6XV

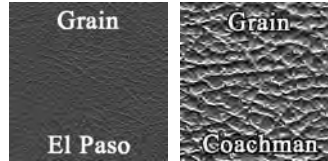

Front Buckets ..... **AA71CLV0010(C)**  
**(All colors)** ..... \$574/pr.

\*Molded foam is available for this model. See the "Molded Foam" section in this catalog.

Rear Bench ..... **AA71CLV0048(C)**  
**(All colors)** ..... \$403/ea.

## 1972 DUSTER & DEMON

This Legendary product features as-original Coachman grain inserts with Cologne grain skirts.

### (C) COLOR CODES:

**(100) - Black** [Trim Codes C6X9, F6X9]

**(200) - White** [Trim Codes C6XW, F6XW]

\*\*\*Duster Trim Codes - C6X9, C6XW

\*\*\*Demon Trim Codes - F6X9, F6XW

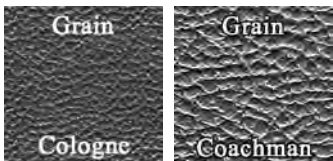

Front Buckets ..... **AA72CLV0010(C)**  
**(All colors)** ..... \$597/pr.

\*Metal emblems not included.

Rear Bench ..... **AA72CLV0048(C)**  
**(All colors)** ..... \$403/ea.

\*Metal emblems not included.

## 1973 DUSTER & DART SPORT

This Legendary product features as-original Shallow Elk grain inserts with Coachman grain skirts.

### (C) COLOR CODES:

**(100) - Black** [Trim Codes C6X9, F6X9]

**(200) - White** [Trim Codes C6XW, F6XW]

**(253) - Metallic Parchment (252) / Parchment (250)** [Trim Codes C6L3, F6L3]

\*\*\*Duster Trim Codes - C6X9, C6XW, C6L3

\*\*\*Dart Sport Trim Codes - F6X9, F6XW, F6L3

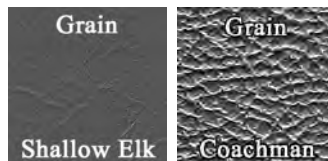

Front Buckets ..... **AA73CLV0010(C)**

**100, 200** ..... \$574/pr.

**253** ..... \$954/pr. **(L1)**

\*Molded foam is available for this model. See the "Molded Foam" section in this catalog.

Fixed Rear Bench ..... **AA73CLVD070(C)**

Fold-Down Rear Bench ..... **AA73CLVD045(C)**

**100, 200** ..... \$394/ea.

**253** ..... \$771/ea. **(L1)**

Rear Fold-Down Carpet Kit (80/20 Loop) ..... **SK73CLV0019(C)**

Rear Fold-Down Carpet Kit (Cut-pile) ..... **SK73CLV0019(C)P**

**(All colors)** ..... \$226/kit

\*Please refer to carpet color selection at time of order.

\*Kit Includes: (1) Rear Seat Panel Carpet, (1) Trunk Compartment Panel Carpet & (1) Center Floorpan Panel Carpet



**1974-75 DART SPORT "HANG 10"**

This Legendary product features as-original Multi-color Striped inserts with Oxford grain skirts.

**(C) COLOR CODES:**

(800) - White, Yellow, Orange, Blue / White [Trim Code J6VW]

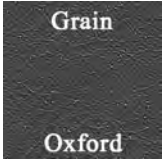
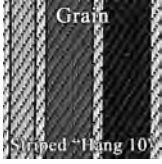

ACCORDING TO  
RIDLEY...  
BELIEVE IT!!

Official  
LEGENDARY  
Tech-Topics



Front Buckets ..... **AA74CLH0010(C)**  
800 ..... \$1168/pr. (L1)  
*\*Molded foam is available for this model. See the "Molded Foam" section in this catalog.*

Rear Fold Down Bench ..... **AA74CLH0045(C)**  
800 ..... \$1013/ea. (L1)

Rear Fold-Down Carpet Kit (Cut-pile) ..... **SK73CLV0019(C)P**  
(All colors) ..... \$226/ea.

*\*Please refer to carpet color selection at time of order.  
\*Kit Includes: (1) Rear Seat Panel Carpet, (1) Trunk Compartment Panel Carpet & (1) Center Floorpan Panel Carpet*

**1974 DUSTER & DART SPORT**

This Legendary product features as-original Shallow Elk grain inserts with Oxford grain skirts.

**(C) COLOR CODES:**

(100) - Black [Trim Codes C6X9, F6X9]  
(200) - White [Trim Codes C6XW, F6XW]  
(267) - Metallic Parchment (266) / Parchment (264) [Trim Codes C6L3, F6L3]

\*\*\*Duster Trim Codes - C6X9, C6XW, C6L3  
\*\*\*Dart Sport Trim Codes - F6X9, F6XW, F6L3



Front Buckets ..... **AA74CLV0010(C)**  
100, 200 ..... \$574/pr.  
267 ..... \$1349/pr. (L1)  
*\*Molded foam is available for this model. See the "Molded Foam" section in this catalog.*

Fixed Rear Bench ..... **AA74CLVD070(C)**  
Fold-Down Rear Bench ..... **AA74CLVD045(C)**  
100, 200 ..... \$394/ea.  
267 ..... \$1162/ea. (L1)

Rear Fold-Down Carpet Kit (Cut-pile) ..... **SK73CLV0019(C)P**  
(All colors) ..... \$226/kit

*\*Please refer to carpet color selection at time of order.  
\*Kit Includes: (1) Rear Seat Panel Carpet, (1) Trunk Compartment Panel Carpet & (1) Center Floorpan Panel Carpet*

**1975-76 DUSTER & DART SPORT**

This Legendary product features as-original Shallow Elk grain inserts with Oxford grain skirts.

**(C) COLOR CODES:**

(100) - Black [Trim Code C6X9]  
(200) - White [Trim Code C6XW]

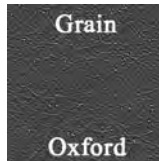
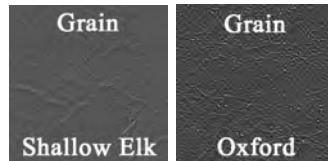

Front Buckets ..... **AA75CLV0010(C)**  
(All colors) ..... \$574/pr.  
*\*Molded foam is available for this model. See the "Molded Foam" section in this catalog.*

Center Cushion/Armrest ..... **CR75CLV0013(C)**  
(All colors) ..... \$104/ea.

Fixed Rear Bench ..... **AA74CLVD070(C)**  
Fold-Down Rear Bench ..... **AA74CLVD045(C)**  
(All colors) ..... \$394/ea.

Rear Fold-Down Carpet Kit (Cut-pile) ..... **SK73CLV0019(C)P**  
(All colors) ..... \$226/kit

*\*Please refer to carpet color selection at time of order.  
\*Kit Includes: (1) Rear Seat Panel Carpet, (1) Trunk Compartment Panel Carpet & (1) Center Floorpan Panel Carpet*



## 1970 DUSTER

This Legendary product features as-original 3/5" Rib grain inserts with Coachman grain skirts.

**(C) COLOR CODES:**

- (100) - Black [Trim Code L2X9]
- (351) - Light Blue (332) / Dark Blue (330) [Trim Code L2B7]
- (435) - Light Green (432) / Dark Green (434) [Trim Code L2F8]



- Front Split Bench ..... AA70CLV0020(C)  
(All colors)..... \$574/ea.
- Rear Bench..... AA70CLV2080(C)  
(All colors)..... \$403/ea.

## 1970 DUSTER

This Legendary product features as-original Laredo grain inserts with Coachman grain skirts.

**(C) COLOR CODES:**

- (100) - Black [Not a factory option]  
\*\*\*Black was not originally offered, but may be purchased as a special order.  
Available only as a prepaid, non-refundable and non-returnable order.
- (155) - Charcoal (156) / Black (100) [Trim Code L4X9]
- (330) - Dark Blue [Trim Code L4B7]
- (434) - Dark Green [Trim Code L4F8]
- (550) - Red [Trim Code L4E4]
- (656) - Brown [Trim Code L4T5]



- Front Split Bench with Center Armrest ..... AA70CVD0030(C)  
(All colors)..... \$597/ea.  
*\*Metal emblems not included.*
- Rear Bench..... AA70CVD0048(C)  
(All colors)..... \$403/ea.  
*\*Metal emblems not included.*

## 1970 DUSTER

This Legendary product features as-original Laredo grain inserts with Coachman grain skirts.

**(C) COLOR CODES:**

- (100) - Black [Trim Code D2X9]
- (330) - Dark Blue [Trim Code D2B7]
- (434) - Dark Green [Trim Code D2F8]



- Front Split Bench ..... AA70CV00020(C)  
(All colors)..... \$574/ea.
- Rear Bench..... AA70CV00080(C)  
(All colors)..... \$403/ea.

## 1971 DUSTER & DEMON

This Legendary product features as-original 3/5" Rib grain inserts with Coachman grain skirts.

**(C) COLOR CODES:**

- (100) - Black [Trim Codes L2X9, E2X9]
- (351) - Light Blue (332) / Dark Blue (330) [Trim Codes L2B7, E2B7]
- (664) - Brown [Trim Codes L2T7, E2T7]
- \*\*\*Duster Trim Codes - L2X9, L2B7, L2T7
- \*\*\*Demon Trim Codes - E2X9, E2B7, E2T7



- Front Split Bench ..... AA70CLV0020(C)  
(All colors)..... \$574/ea.
- Rear Bench..... AA70CLV2080(C)  
(All colors)..... \$403/ea.



**1971 DUSTER**

This Legendary product features as-original El Paso grain inserts with Coachman grain skirts.

**(C) COLOR CODES:**

- (152) - Charcoal (154) / Black (100) [Trim Code L4X9]
- (351) - Light Blue (332) / Dark Blue (330) [Trim Code L4B7]
- (451) - Light Green (432) / Dark Green (452) [Trim Code L4F7]
- (665) - Tan (668) / Brown (664) [Trim Code L4T7]
- (666) - Ember Gold [Trim Code L4Y3]

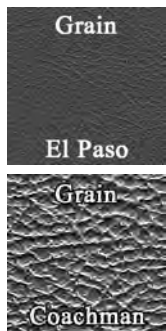

- Front Split Bench with Center Armrest ..... **AA71CV00030(C)**  
(All colors).....\$597/ea.
- Rear Bench..... **AA71CLV0048(C)**  
(All colors).....\$403/ea.

**1971 DUSTER & DEMON  
"CLOTH STYLE"**

This Legendary product features as-original Plaid cloth inserts with Coachman grain skirts.

**(C) COLOR CODES:**

- (829) - Blue Plaid Cloth (836) / Dark Blue (330) [Trim Codes L1B7, M1B7]
- (831) - Black & White Plaid Cloth (830) / Black (100) [Trim Codes L1XX, M1XX]
- (833) - Green & Yellow Plaid Cloth (837) / Dark Green (434) [Trim Codes L1F7, M1F7]
- (835) - Black & Orange Plaid Cloth (834) / Black (100) [Trim Codes L1X9, M1X9]

\*\*\*Duster Trim Codes - L1B7, L1XX, L1F7, L1X9  
\*\*\*Demon Trim Codes - M1B7, M1XX, M1F7, M1X9



- Front Split Bench ..... **AA71CLVC020(C)**  
**829, 833, 835**.....\$1035/ea. (L1)  
**831**.....\$1000/ea. (L4)
- Rear Bench..... **AA71CLVC080(C)**  
**829, 833, 835**.....\$854/ea. (L1)  
**831**.....\$824/ea. (L4)

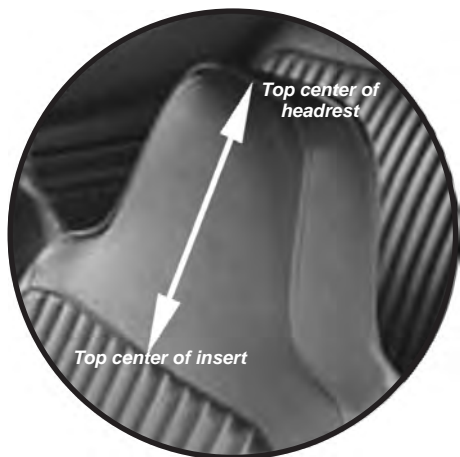

**FAST FACTS!!**  
**WHAT? 7" OR 9" HEADRESTS?**

A common problem when ordering standard split bench vinyl 9" headrests is the determination of 7" or 9" headrests. In 1972 "integral" headrests were standard on Dodge Dart, Demon and Plymouth Duster models equipped with standard all vinyl split bench seats (shown on right). To determine which size headrests your car has, simply take a ruler measuring from the top center of the insert to top center of the headrests area.

**ACCORDING TO  
RIDLEY...  
BELIEVE IT!!**

Official  
**LEGENDARY**  
Tech-Topics

# Chrysler, Dodge, Plymouth

## 1972 DUSTER & DEMON

This Legendary product features as-original  
Shallow Elk grain inserts with Coachman grain skirts.

### (C) COLOR CODES:

- (100) - Black [Trim Code D2X9]
- (340) - Bright Blue [Trim Code D2B5]
- (445) - Light Green (432) / Dark Green (444) [Trim Code D2F6]
- (666) - Ember Gold [Trim Code D2Y3]



- Front Split Bench  
(7" high headrest) ..... AA72CLV7020(C)  
(9" high headrest) ..... AA72CLV9020(C)  
(All colors) ..... \$574/ea.  
*\*Please specify 7" or 9" headrest at time of order.  
\*Measure the integral headrest from the top center of the insert to the top center of the headrest.*
- Rear Bench ..... AA72CLV0080(C)  
(All colors) ..... \$403/ea.

## 1972 DUSTER & DEMON

This Legendary product features as-original  
Coachman grain inserts with Cologne grain skirts.

### (C) COLOR CODES:

- (100) - Black [Trim Codes C4X9, F4X9]
  - (200) - White [Trim Code C4XW]
  - (340) - Bright Blue [Trim Code C4B5]
  - (444) - Dark Green [Trim Codes C4F6, F4F6]
  - (666) - Ember Gold [Trim Codes C4Y3, F4Y3]
- \*\*\*Duster Trim Codes - C4X9, C4XW, C4B5, C4F6, C4Y3  
\*\*\*Demon Trim Codes - F4X9, F4F6, F4Y3



- Front Split Bench with Center Armrest ..... AA72CLV0030(C)  
(All colors) ..... \$597/ea.  
*\*Metal emblems not included.*
- Rear Bench ..... AA72CLV0048(C)  
(All colors) ..... \$403/ea.  
*\*Metal emblems not included.*

## 1972-73 DUSTER, DEMON & DART SPORT "CLOTH STYLE"

This Legendary product features as-original  
Plaid cloth inserts with Coachman grain skirts.

### (C) COLOR CODES:

- (831) - Black & White Plaid Cloth (830) / Black (100) [Trim Codes B1X9, A1X9]
  - (838) - Blue Plaid Cloth (836) / Bright Blue (340) [Trim Codes B1B5, A1B5]
  - (839) - Yellow & Green Cloth (837) / Dark Green (444) [Trim Codes B1F6, A1F6]
- \*\*\*1972 Duster & Demon Trim Codes - B1X9, B1B5, B1F6  
\*\*\*1973 Duster & Dart Sport Trim Codes - A1X9, A1B5, A1F6



- Front Split Bench ..... AA72CLVC020(C)  
831 ..... \$1031/ea. (L4)  
838, 839 ..... \$1035/ea. (L1)
- Fixed Rear Bench ..... AA72CLVC080(C)  
831 ..... \$849/ea. (L4)  
838, 839 ..... \$854/ea. (L1)

## 1973 DUSTER & DART SPORT

This Legendary product features as-original  
Shallow Elk grain inserts with Coachman grain skirts.

### (C) COLOR CODES:

- (100) - Black [Trim Code D2X9]
- (253) - Metallic Parchment (252) / Parchment (250) [Trim Code D2L3]
- (352) - Metallic Blue (341) / Bright Blue (340) [Trim Code D2B5]
- (449) - Metallic Green (448) / Dark Green (444) [Trim Code D2F6]
- (675) - Metallic Bronze (674) / Honey Gold (672) [Trim Code D2Y4]

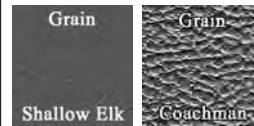

- Front Split Bench ..... AA73CLVS020(C)  
100 ..... \$574/ea.  
253 ..... \$954/ea. (L4)  
449 ..... \$954/ea. (L1)  
352 ..... \$558/ea. (L4)  
675 ..... \$1349/ea. (L4)
- Fixed Rear Bench ..... AA73CLVS070(C)  
Fold-Down Rear Bench ..... AA73CLVS082(C)  
100 ..... \$403/ea.  
253 ..... \$771/ea. (L4)  
449 ..... \$771/ea. (L1)  
352 ..... \$403/ea. (L4)  
675 ..... \$1176/ea. (L4)
- Rear Fold-Down Carpet Kit (80/20 Loop) OS2 ..... SK73CLV0019(C)  
Rear Fold-Down Carpet Kit (Cut-pile) OS2 ..... SK73CLV0019(C)P  
(All colors) ..... \$226/kit  
*\*Please refer to carpet color selection at time of order.  
\*Kit Includes: (1) Rear Seat Panel Carpet, (1) Trunk Compartment Panel Carpet & (1) Center Floorpan Panel Carpet*



### 1973 DUSTER & DART SPORT

This Legendary product features as-original  
Shallow Elk grain inserts with Coachman grain skirts.

**(C) COLOR CODES:**

- (100) - Black [Trim Codes C4X9, F4X9]
- (253) - Metallic Parchment (252) / Parchment (264) [Trim Codes C4L3, F4L3]
- (352) - Metallic Blue (341) / Bright Blue (340) [Trim Codes C4B5, F4B5]
- (449) - Metallic Green (448) / Dark Green (444) [Trim Codes C4F6, F4F6]

\*\*\*Duster Trim Codes - C4X9, C4L3, C4B5, C4F6  
\*\*\*Dart Sport Trim Codes - F4X9, F4L3, F4B5, F4F6

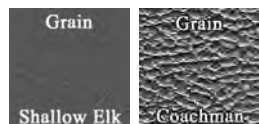

- Front Split Bench w/ Center Armrest .... **AA73CLVD030(C)**
- 100.....\$597/ea.
- 253, 449.....\$978/ea. (L1)
- 352.....\$580/ea. (L4)

- Fixed Rear Bench.....**AA73CLVD070(C)**
- Fold-Down Rear Bench .....**AA73CLVD045(C)**
- 100.....\$394/ea.
- 253, 449.....\$771/ea. (L1)
- 352.....\$382/ea. (L4)

- Rear Fold-Down Carpet Kit (80/20 Loop) ..... **SK73CLV0019(C)**
- Rear Fold-Down Carpet Kit (Cut-pile) ..... **SK73CLV0019(C)P**
- (All colors).....\$226/kit

\*Please refer to carpet color selection at time of order.  
\*Kit Includes: (1) Rear Seat Panel Carpet, (1) Trunk Compartment Panel Carpet & (1) Center Floorpan Panel Carpet

### 1974-76 DUSTER & DART SPORT

This Legendary product features as-original  
Shallow Elk grain inserts with Oxford grain skirts.

**(C) COLOR CODES:**

- (100) - Black [Trim Codes D2X9, E2X9] - 1974-1976
- (267) - Metallic Parchment (266) / Parchment (264) [Trim Codes D2L3, E2L3] - 1974-1976
- (348) - Light Blue (347) / Lagoon Blue (360) [Trim Code E2B6] - 1976 only
- (360) - Lagoon Blue [Trim Codes D2B6, E2B6] - 1974-1975
- (450) - Jade Green [Trim Codes D2G6, E2G6] - 1974-1975
- (453) - Light Green [Trim Code E2F6] - 1976 only
- (680) - Ember Gold [Trim Code D2Y3] - 1974 only
- (685) - Gold (679) / Ember Gold (680) [Trim Code E2Y3]- 1975-1976

\*\*\*1974-1975 Duster & Dart Sport Trim Codes - D2X9, D2L3, D2B6, D2G6, D2Y3  
\*\*\*1975 Duster Custom Trim Codes - E2X9, E2L3, E2B6, E2G6, E2Y3  
\*\*\*1976 Duster & Dart Sport Trim Codes - E2X9, E2L3, E2B6, E2F6, E2Y3

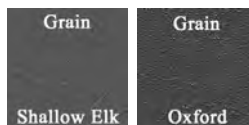

- Front Split Bench (1974) ..... **AA74CLVS020(C)**
- Front Split Bench (1975-76) ..... **AA75CLVS020(C)**
- 100, 360, 450 .....\$574/ea.
- 348.....\$1013/ea. (L1)
- 267, 453, 680, 685.....\$1349/ea. (L1)

- Fixed Rear Bench.....**AA74CLVS070(C)**
- Fold-Down Rear Bench .....**AA74CLVS082(C)**
- 100, 360, 450.....\$403/ea.
- 348.....\$803/ea. (L1)
- 267, 453, 680, 685.....\$1176/ea. (L1)

- Rear Fold-Down Carpet Kit (Cut-pile) ..... **SK73CLV0019(C)P**
- (All colors).....\$226/kit

\*Please refer to carpet color selection at time of order.  
\*Kit Includes: (1) Rear Seat Panel Carpet, (1) Trunk Compartment Panel Carpet & (1) Center Floorpan Panel Carpet

### 1974-75 DUSTER & DART SPORT

This Legendary product features as-original  
Shallow Elk grain inserts with Oxford grain skirts.

**(C) COLOR CODES:**

- (100) - Black [Trim Codes F4X9, C4X9] - 1974-1975
- (267) - Metallic Parchment (266) / Parchment (264) [Trim Codes F4L3, C4L3] - 1974-1975
- (360) - Lagoon Blue [Trim Codes F4B6, C4B6] - 1974 only
- (450) - Jade Green [Trim Codes F4G6, C4G6] - 1974-1975
- (685) - Gold (679) / Ember Gold (680) [Trim Code C4Y3]- 1975 only

\*\*\*1974 Dart Sport Trim Codes - F4X9, F4L3, F4B6, F4G6  
\*\*\*1975 Dart Sport & 1974-1975 Duster Trim Codes - C4X9, C4L3, C4B6, C4G6, C4F6, C4Y3

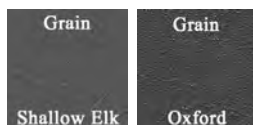

- Front Split Bench w/ Center Armrest .... **AA74CLVD030(C)**
- 100, 360, 450.....\$597/ea.
- 267, 685.....\$1371/ea. (L1)

- Fixed Rear Bench ..... **AA74CLVD070(C)**
- Fold-Down Rear Bench ..... **AA74CLVD045(C)**
- 100, 360, 450.....\$394/ea.
- 267, 685.....\$1162/ea. (L1)

- Rear Fold-Down Carpet Kit (Cut-pile) ..... **SK73CLV0019(C)P**
- (All colors).....\$226/kit

\*Please refer to carpet color selection at time of order.  
\*Kit Includes: (1) Rear Seat Panel Carpet, (1) Trunk Compartment Panel Carpet & (1) Center Floorpan Panel Carpet

### 1975 DUSTER & DART SPORT "CLOTH STYLE"

This Legendary product features as-original  
Cloth inserts with Oxford grain skirts.

**(C) COLOR CODES:**

- (954) - Parchment Cloth (918) / Parchment (264) [Trim Code C3L3]

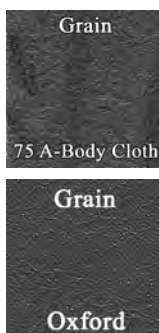

- Front Split Bench with Center Armrest ..... **AA74CLVDC30(C)**
- 954.....\$1484/ea. (L1)

- Fixed Rear Bench.....**AA74CLVDC70(C)**
- Fold-Down Rear Bench ..... **AA74CLVDC82(C)**
- 954.....\$1236/ea. (L1)

- Rear Fold-Down Carpet Kit (Cut-pile) ..... **SK73CLV0019(C)P**
- (All colors).....\$226/kit

\*Please refer to carpet color selection at time of order.  
\*Kit Includes: (1) Rear Seat Panel Carpet, (1) Trunk Compartment Panel Carpet & (1) Center Floorpan Panel Carpet

# Seat Upholstery Installation Kits Are Available To Help Complete Your Install!!

Seat upholstery Installation Kits from Legendary give you the products you need to do the job yourself!! All components are upholstery grade and have been hand selected by our team of installation experts to provide the highest quality materials available.



Check Out the Installation Kits Section For More Information

\*Right After Seat Upholstery Section

## 1964-65 BARRACUDA

This Legendary product features as-original heat sealed Bison grain inserts with Bison grain skirts.

**(C) COLOR CODES:**

- (100) - Black [Trim Codes P5X, P4X]
- (314) - Blue [Trim Codes P5B, P4B]
- (510) - Crimson Red [Trims Code P5R, P4R]
- (614) - Gold [Trim Codes P5Y, P4Y]

\*\*\*1964 Barracuda Trim Codes - P5X, P5B, P5R, P5Y  
 \*\*\*1965 Barracuda Trim Codes - P4X, P4B, P4R, P4Y

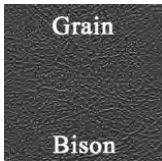

Front Buckets ..... **AA64CBV0010(C)**  
**(All colors)**..... \$709/pr.  
 \*Please specify carpet color of stretch panel at time of order.  
 \*Molded foam is available for this model. See the "Molded Foam" section in this catalog.

Front Bucket Seatback Panels  
 (Pre-sewn vinyl panels with new boards)  
 (1964) (small welt) ..... **SK64CB00018(C)**  
 (1965) (large welt) ..... **SK65CBV0018(C)**  
 (All vinyl) ..... \$193/pr.

Rear Bench ..... **AA64CB00070(C)**  
**(All colors)**..... \$569/ea.  
 \*Original brass vent grommets must be reused.

Rear Fold-Down Carpet Kit (80/20 Loop)  ..... **SK64CB00019(C)**  
**(All colors)**..... \$186/ea.  
 \*Please refer to carpet color selection at time of order.

## 1966 BARRACUDA

This Legendary product features as-original heat sealed Cologne grain inserts with Cologne grain skirts.

**(C) COLOR CODES:**

- (100) - Black [Trim Code P4X]
- (202) - Pearl White [Trim Code P4V]
- (320) - Navy [Trim Code P4B]
- (420) - Citron [Trim Code P4Y]
- (505) - Red [Trim Code P4H]

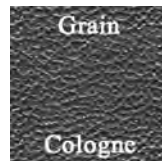

Front Buckets ..... **AA66CB00010(C)**  
**(All colors)**..... \$569/pr.  
 \*Molded foam is available for this model. See the "Molded Foam" section in this catalog.

Rear Bench ..... **AA66CB00070(C)**  
**(All colors)** ..... \$545/ea.  
 \*Original brass vent grommets must be reused.



### 1967 BARRACUDA

This Legendary product features as-original Cologne grain inserts with Cologne grain skirts.

**(C) COLOR CODES:**

- (100) - Black [Trim Code H6X]
- (202) - Pearl White [Trim Codes H6W, H6C, H6V]
- \*H6W - Pearl White w/ Black Carpet
- \*H6C - Pearl White w/ Blue Carpet
- \*H6V - Pearl White w/ Red Carpet
- (320) - Navy [Trim Code H6B]
- (520) - Red [Trim Code H6R]
- (618) - Light Tan [Trim Code H6T]
- (620) - Copper [Trim Code H6K]

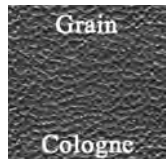

Front Buckets .....	<b>AA67CB00010(C)</b>
<b>100, 202, 320, 520, 620</b> .....	\$569/pr.
<b>618</b> .....	\$1194/pr. (L1)
<i>*Molded foam is available for this model. See the "Molded Foam" section in this catalog.</i>	
Hardtop Rear Bench .....	<b>AA67CB00048(C)</b>
Convertible Rear Bench .....	<b>AA67CB00056(C)</b>
Fastback Rear Bench .....	<b>AA67CB00070(C)</b>
<b>100, 202, 320, 520, 620</b> .....	\$394/ea.
<b>618</b> .....	\$1015/ea. (L1)

### 1968 BARRACUDA "STANDARD"

This Legendary product features as-original Cologne grain inserts with Cologne grain skirts.

**(C) COLOR CODES:**

- (100) - Black [Trim Code H6X]
- (202) - Pearl White [Trim Code H6W, H6C, H6D, H6V]
- \*H6W - Pearl White w/ Black Carpet
- \*H6C - Pearl White w/ Blue Carpet
- \*H6D - Pearl White w/ Green Carpet
- \*H6V - Pearl White w/ Maroon Carpet
- (332) - Blue [Trim Code H6B]
- (430) - Green [Trim Code H6F]
- (526) - Maroon [Trim Code H6R]

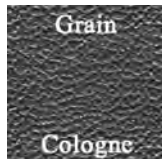

Front Buckets .....	<b>AA68CBS0010(C)</b>
<b>(All colors)</b> .....	\$574/pr.
<i>*Molded foam is available for this model. See the "Molded Foam" section in this catalog.</i>	
Front Bucket Seatback Panels .....	<b>SK68AB00018(C)</b>
<b>(All colors)</b> .....	\$175/pr.
<i>(New boards wrapped in vinyl with mounting hardware attached as original. Ready to install.)</i>	
Hardtop Rear Bench .....	<b>AA68CBS0048(C)</b>
Convertible Rear Bench .....	<b>AA68CBS0056(C)</b>
Fastback Rear Bench .....	<b>AA68CBS0070(C)</b>
<b>(All colors)</b> .....	\$403/ea.

### 1968 BARRACUDA "STANDARD" "RALLYE SEAT"

This Legendary product features as-original Cologne grain inserts with Cologne grain skirts.

**(C) COLOR CODES:**

- (100) - Black
- (202) - Pearl White
- (332) - Blue
- (430) - Green
- (526) - Maroon

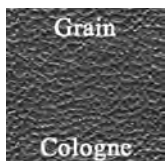

Front Buckets .....	<b>RS68CBS0010(C)</b>
<b>(All colors)</b> .....	\$971/pr.
<i>*Kit consists of: (1) pair Rallye Bucket Seat Upholstery, (1) set Rallye Bucket Seat Foam, (4) Front Seat Top Spring to Frame Hold Back Listing, (1 yd) Muslin, (30 ft) Listing Wire, (2 yds) Burlap, (9 ft) 2 inch Felt and (1) Dust Mask.</i>	
Front Bucket Seatback Panels .....	<b>SK68AB00018(C)</b>
<b>(All colors)</b> .....	\$175/pr.
<i>(New boards wrapped in vinyl with mounting hardware attached as original. Ready to install.)</i>	
Hardtop Rear Bench .....	<b>AA68CBS0048(C)</b>
Convertible Rear Bench .....	<b>AA68CBS0056(C)</b>
Fastback Rear Bench .....	<b>AA68CBS0070(C)</b>
<b>(All colors)</b> .....	\$403/ea.

### 1968 BARRACUDA "DELUXE"

This Legendary product features as-original Cologne and Rosette grain inserts with Cologne grain skirts.

**(C) COLOR CODES:**

- (100) - Black [Trim Code D6X]
- (202) - Pearl White [Trim Codes D6W, D6C, D6D, D6E, D6V]
- \*D6W - Pearl White w/ Black Carpet
- \*D6C - Pearl White w/ Blue Carpet
- \*D6D - Pearl White w/ Green Carpet
- \*D6E - Pearl White w/ Gold Carpet
- \*D6V - Pearl White w/ Maroon Carpet
- (332) - Blue [Trim Code D6B]
- (430) - Green [Trim Code D6F]
- (526) - Maroon [Trim Code D6R]
- (636) - Gold [Trim Code D6Y]

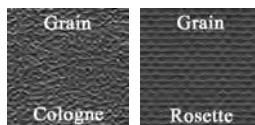

Front Buckets .....	<b>AA68CBD0010(C)</b>
<b>(All colors)</b> .....	\$574/pr.
<i>*Molded foam is available for this model. See the "Molded Foam" section in this catalog.</i>	
Front Bucket Seatback Panels .....	<b>SK68CBD0018(C)</b>
<b>(All colors)</b> .....	\$175/pr.
<i>(New boards fully carpeted with vinyl binding and mounting hardware attached as original. Ready to install.)</i>	
<i>*Please refer to carpet color selection to specify carpet color at time of order.</i>	
Hardtop Rear Bench .....	<b>AA68CBD0040(C)</b>
Convertible Rear Bench .....	<b>AA68CBD0050(C)</b>
Fastback Rear Bench .....	<b>AA68CBD0070(C)</b>
<b>(All colors)</b> .....	\$403/ea.

## 1968 BARRACUDA "DELUXE" "RALLYE SEAT"

This Legendary product features as-original Cologne and Rosette grain inserts with Cologne grain skirts.

**(C) COLOR CODES:**

- (100) - Black
- (202) - Pearl White
- (332) - Blue
- (430) - Green
- (526) - Maroon
- (636) - Gold

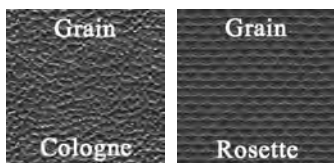

Front Buckets ..... **RS68CBD0010(C)**   
(All colors)..... \$971/pr.

\*Kit consists of: (1) pair Rallye Bucket Seat Upholstery, (1) set Rallye Bucket Seat Foam, (4) Front Seat Top Spring to Frame Hold Back Listing, (1 yd) Muslin, (30 ft) Listing Wire, (2 yds) Burlap, (9 ft) 2 inch Felt and (1) Dust Mask.

Front Bucket Seatback Panels ..... **SK68CBD0018(C)**  
(New boards fully carpeted with vinyl binding and mounting hardware attached as original. Ready to install.)  
(All colors)..... \$175/pr.  
\*Please refer to carpet color selection to specify carpet color at time of order.

Hardtop Rear Bench ..... **AA68CBD0040(C)**  
Convertible Rear Bench ..... **AA68CBD0050(C)**  
Fastback Rear Bench ..... **AA68CBD0070(C)**  
(All colors)..... \$403/ea.

## 1969 BARRACUDA "STANDARD"

This Legendary product features as-original Coachman grain inserts with Coachman grain skirts.

**(C) COLOR CODES:**

- (100) - Black [Trim Code H6X]
- (200) - White [Trim Codes H6W, H6C, H6F, H6V]  
\*H6W - White w/ Black Carpet  
\*H6C - White w/ Blue Carpet  
\*H6F - White w/ Green Carpet  
\*H6V - White w/ Red Carpet
- (338) - Bright Blue [Trim Code H6B]
- (434) - Green [Trim Code H6G]
- (528) - Red [Trim Code H6R]



Front Buckets ..... **AA69CBS0010(C)**  
(All colors)..... \$574/pr.

\*Molded foam is available for this model. See the "Molded Foam" section in this catalog.

Front Bucket Seatback Panels ..... **SK69AB00018(C)**  
(New boards wrapped in vinyl with mounting hardware attached as original. Ready to install.)  
(All colors)..... \$175/pr.

Hardtop Rear Bench ..... **AA69CBS0048(C)**  
Convertible Rear Bench ..... **AA69CBS0056(C)**  
Fastback Rear Bench ..... **AA69CBS0070(C)**  
(All colors)..... \$403/ea.

## 1969 BARRACUDA "STANDARD" "RALLYE SEAT"

This Legendary product features as-original Coachman grain inserts with Coachman grain skirts.

**(C) COLOR CODES:**

- (100) - Black
- (200) - White
- (338) - Bright Blue
- (434) - Green
- (528) - Red



PHOTO N/A  
AT TIME OF  
PRINTING

Front Buckets ..... **RS69CBS0010(C)**   
(All colors)..... \$971/pr.

\*Kit consists of: (1) pair Rallye Bucket Seat Upholstery, (1) set Rallye Bucket Seat Foam, (4) Front Seat Top Spring to Frame Hold Back Listing, (1 yd) Muslin, (30 ft) Listing Wire, (2 yds) Burlap, (9 ft) 2 inch Felt and (1) Dust Mask.

Front Bucket Seatback Panels ..... **SK69AB00018(C)**  
(New boards wrapped in vinyl with mounting hardware attached as original. Ready to install.)  
(All colors)..... \$175/pr.

Hardtop Rear Bench ..... **AA69CBS0048(C)**  
Convertible Rear Bench ..... **AA69CBS0056(C)**  
Fastback Rear Bench ..... **AA69CBS0070(C)**  
(All colors)..... \$403/ea.

## 1969 BARRACUDA "DELUXE"

This Legendary product features as-original El Paso grain inserts with Coachman grain skirts.

**(C) COLOR CODES:**

- (100) - Black [Trim Code D6X]
- (130) - Pewter [Trim Code D6S]
- (338) - Bright Blue [Trim Code D6B]
- (434) - Green [Trim Code D6G]
- (528) - Red [Trim Code D6R]
- (644) - Yellow [Trim Code D6P]
- (650) - Saddle [Trim Codes D6T, D6J, D6U]  
\*D6T - Saddle w/ Saddle Carpet  
\*D6J - Saddle w/ Green Carpet  
\*D6U - Saddle w/ Black Carpet

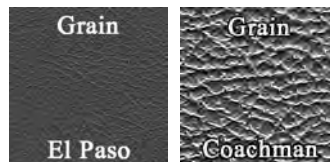

Front Buckets ..... **AA69CBD0010(C)**  
(All colors)..... \$574/pr.

\*Metal emblems not included.

\*Molded foam is available for this model. See the "Molded Foam" section in this catalog.

Front Bucket Seatback Panels ..... **SK69AB00018(C)**  
(New boards wrapped in vinyl with mounting hardware attached as original. Ready to install.)  
(All colors)..... \$175/pr.

Hardtop Rear Bench ..... **AA69CBD0040(C)**  
Convertible Rear Bench ..... **AA69CBD0050(C)**  
Fastback Rear Bench ..... **AA69CBD0070(C)**  
(All colors)..... \$403/ea.



### 1969 BARRACUDA "STANDARD" "RALLYE SEAT"

This Legendary product features as-original El Paso grain inserts with Coachman grain skirts.

**(C) COLOR CODES:**

- (100) - Black
- (130) - Pewter
- (338) - Bright Blue
- (434) - Green
- (528) - Red
- (644) - Yellow
- (650) - Saddle

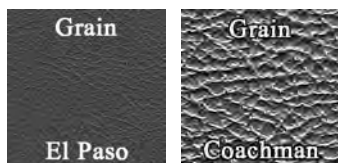

PHOTO N/A  
AT TIME OF  
PRINTING

- Front Buckets ..... **RS69CBD0010(C)** **052**  
(All colors)..... \$971/pr.  
*\*Kit consists of: (1) pair Rallye Bucket Seat Upholstery, (1) set Rallye Bucket Seat Foam, (4) Front Seat Top Spring to Frame Hold Back Listing, (1 yd) Muslin, (30 ft) Listing Wire, (2 yds) Burlap, (9 ft) 2 inch Felt and (1) Dust Mask.*
- Front Bucket Seatback Panels ..... **SK69AB00018(C)**  
(New boards wrapped in vinyl with mounting hardware attached as original. Ready to install.)  
(All colors)..... \$175/pr.
- Hardtop Rear Bench ..... **AA69CBD0040(C)**
- Convertible Rear Bench ..... **AA69CBD0050(C)**
- Fastback Rear Bench ..... **AA69CBD0070(C)**  
(All colors)..... \$403/ea.

### 1969 "MOD TOP" BARRACUDA

This Legendary product features as-original Yellow Mod inserts with Coachman grain skirts.

**(C) COLOR CODES:**

- (645) - Yellow Mod (642) / Yellow (644) [Trim Code F6P]
- (677) - Yellow Mod (642) / Green (434) [Trim Code F6J]



- Front Buckets ..... **AA69CBM0010(C)**  
**645, 677**..... \$954/pr. (L2)  
*\*Molded foam is available for this model. See the "Molded Foam" section in this catalog.*
- Hardtop Rear Bench ..... **AA69CBM0040(C)**  
**645, 677**..... \$730/ea. (L2)

### 1969 "MOD TOP" BARRACUDA "RALLYE SEAT"

This Legendary product features as-original Yellow Mod inserts with Coachman grain skirts.

**(C) COLOR CODES:**

- (645) - Yellow Mod (642) / Yellow (644)
- (677) - Yellow Mod (642) / Green (434)

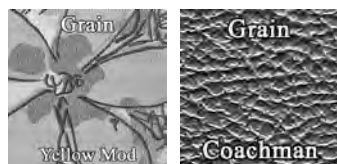

PHOTO N/A  
AT TIME OF  
PRINTING

- Front Buckets ..... **RS69CBM0010(C)** **052**  
**645, 677** ..... \$1463/pr. (L2)  
*\*Kit consists of: (1) pair Rallye Bucket Seat Upholstery, (1) set Rallye Bucket Seat Foam, (4) Front Seat Top Spring to Frame Hold Back Listing, (1 yd) Muslin, (30 ft) Listing Wire, (2 yds) Burlap, (9 ft) 2 inch Felt and (1) Dust Mask.*
- Hardtop Rear Bench ..... **AA69CBM0040(C)**  
**645, 677**..... \$730/ea. (L2)

### 1967 BARRACUDA

This Legendary product features as-original Cologne grain inserts with Cologne grain skirts.

**(C) COLOR CODES:**

- (100) - Black [Trim Code H5X]
- (202) - Pearl White [Trim Codes H5W, H5C, H5V]  
*\*H5W - Pearl White w/ Black Carpet*  
*\*H5C - Pearl White w/ Blue Carpet*  
*\*H5V - Pearl White w/ Red Carpet*
- (320) - Navy [Trim Code H5B]
- (520) - Red [Trim Code H5R]
- (618) - Light Tan [Trim Code H5T]
- (620) - Copper [Trim Code H5K]

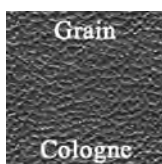

PHOTO N/A  
AT TIME OF  
PRINTING

- Front Split Bench with Center Armrest ..... **AA67CB00030(C)**  
**100, 202, 320, 520, 620**..... \$597/pr.  
**618**..... \$1224/pr. (L1)
- Hardtop Rear Bench ..... **AA67CB00048(C)**
- Convertible Rear Bench ..... **AA67CB00056(C)**
- Fastback Rear Bench ..... **AA67CB00070(C)**  
**100, 202, 320, 520, 620**..... \$394/ea.  
**618**..... \$1015/ea. (L1)



# Chrysler, Dodge, Plymouth

## 1968 BARRACUDA "STANDARD"

This Legendary product features as-original Cologne grain inserts with Cologne grain skirts.

### (C) COLOR CODES:

- (100) - Black [Trim Code H5X]
- (202) - Pearl White [Trim Code H5W, H5C, H5D, H5V]  
\*H5W - Pearl White w/ Black Carpet  
\*H5C - Pearl White w/ Blue Carpet  
\*H5D - Pearl White w/ Green Carpet  
\*H5V - Pearl White w/ Maroon Carpet
- (332) - Blue [Trim Code H5B]

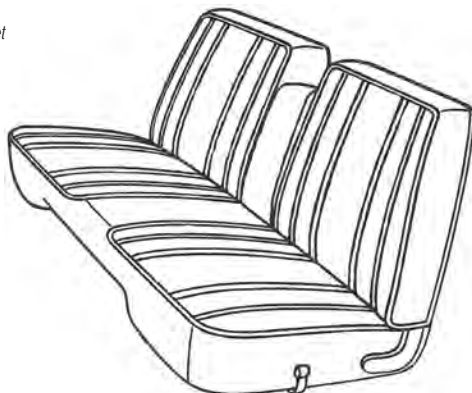
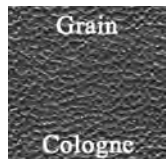

- Front Split Bench with Center Armrest ..... **AA68CBS0030(C)**  
(All colors)..... \$597/pr.
- Hardtop Rear Bench..... **AA68CBS0048(C)**
- Fastback Rear Bench..... **AA68CBS0070(C)**  
(All colors)..... \$403/ea.

## 1969 BARRACUDA "STANDARD"

(\*CUDA 340 & \*CUDA 383 PERFORMANCE PACKAGES)

This Legendary product features as-original Coachman grain inserts with Coachman grain skirts.

### (C) COLOR CODES:

- (100) - Black [Trim Code L2X]
- (338) - Bright Blue [Trim Code L2B]
- (528) - Red [Trim Code L2R]



- Front Split Bench (no center armrest)..... **AA69CBS0020(C)**  
(All colors)..... \$574/ea.
- Hardtop Rear Bench..... **AA69CBS0048(C)**
- Fastback Rear Bench..... **AA69CBS0070(C)**  
(All colors)..... \$403/ea.

## 1969 BARRACUDA "STANDARD"

This Legendary product features as-original Coachman grain inserts with Coachman grain skirts.

### (C) COLOR CODES:

- (100) - Black [Trim Code H4X]
- (200) - White [Trim Codes H4W, H4C, H4F, H4V]  
\*H4W - White w/ Black Carpet  
\*H4C - White w/ Blue Carpet  
\*H4F - White w/ Green Carpet  
\*H4V - White w/ Red Carpet
- (338) - Bright Blue [Trim Code H4B]



- Front Split Bench with Center Armrest ..... **AA69CBS0030(C)**  
(All colors)..... \$597/pr.
- Hardtop Rear Bench..... **AA69CBS0048(C)**
- Fastback Rear Bench..... **AA69CBS0070(C)**  
(All colors)..... \$403/ea.

## 1970 BARRACUDA GRAN COUPE

This Legendary product features as-original heat sealed Shallow Elk grain inserts & accent belts with Ranger grain inset panel & Coachman grain skirts.

### (C) COLOR CODES:

- (100) - Black [Not a factory option]  
\*Black was not originally offered, but may be purchased as a special order.  
Available only as a prepaid, non-refundable and non-returnable order.
- (154) - Charcoal [Trim Code P6A8]
- (200) - White [Trim Codes P6XW, P6BW, P6EW, P6FW]  
\*P6XW - White w/ Black Carpet  
\*P6BW - White w/ Blue Carpet  
\*P6EW - White w/ Red Carpet  
\*P6FW - White w/ Green Carpet
- (338) - Bright Blue [Trim Code P6B5]
- (434) - Green [Trim Code P6F8]
- (540) - Burnt Orange [Trim Code P6K4]
- (550) - Red [Trim Code P6E4]
- (657) - Bronze (654) / Brown (656) [Trim Code P6T5]
- (660) - Gold [Trim Code P6XY]



- Front Buckets ..... **AA70CBD0010(C)**  
\*100, 154, 200, 338, 434, 540, 550, 657 ..... \$620/pr.  
660..... \$1194/pr. (L1)  
\*Metal emblems not included.  
\*Molded foam is available for this model. See the "Molded Foam" section in this catalog.
- Hardtop Rear Bench..... **AA70CBD0040(C)**
- Convertible Rear Bench..... **AA70CBD0050(C)**  
\*100, 154, 200, 338, 434, 540, 550, 657 ..... \$424/ea.  
660..... \$1103/ea. (L1)



## 1970 BARRACUDA & 'CUDA

This Legendary product features as-original Ranger grain inserts with Coachman grain skirts.

**(C) COLOR CODES:**

- (100) - Black [Trim Code H6X9]
- (200) - White [Trim Codes H6XW, H6BW, H6EW, H6FW]  
\*H6XW - White w/ Black Carpet  
\*H6BW - White w/ Blue Carpet  
\*H6EW - White w/ Red Carpet  
\*H6FW - White w/ Green Carpet
- (338) - Bright Blue [Trim Code H6B5]
- (434) - Green [Trim Code H6F8]
- (550) - Red [Trim Code H6E4]
- (657) - Bronze (654) / Brown (656) [Trim Code H6T5]

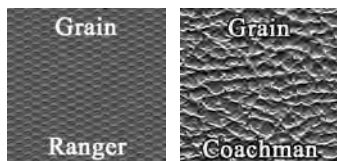

Front Buckets ..... AA70CB00010(C)  
(All colors).....\$597/pr.  
\*Molded foam is available for this model. See the "Molded Foam" section in this catalog.

Hardtop Rear Bench.....AA70CB00048(C)  
Convertible Rear Bench .....AA70CB00056(C)  
(All colors).....\$403/ea.

ACCORDING TO  
RIDLEY...  
BELIEVE IT!!

Official  
LEGENDARY  
Tech-Topics

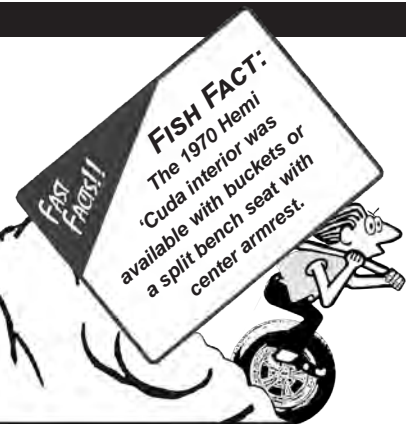

## 1970 BARRACUDA GRAN COUPE "CLOTH STYLE"

This Legendary product features as-original Houndstooth cloth inserts with Coachman grain skirts.

**(C) COLOR CODES:**

- (791) - Black & White Houndstooth Cloth (790) / Black (100)  
with Red insert welt [Trim Code P5X9]
- (793) - Black & Burnt Orange Houndstooth Cloth (792) / Burnt Orange (540)  
with Bright Orange insert welt [Trim Code P5K4]



Front Buckets ..... AA70CBC0010(C)  
(All colors).....\$1038/pr. (L1)  
\*Molded foam is available for this model. Please see the "Molded Foam" section in this catalog.

Hardtop Rear Bench.....AA70CBC0040(C)  
(All colors).....\$681/ea. (L1)

## 1970-71 BARRACUDA, 'CUDA & GRAN COUPE "LEATHER STYLE"

This Legendary product features as-original Leather inserts with Coachman grain skirts.

**(C) COLOR CODES:**

- (100) - Black [Trim Codes PRX9, SRX9] - 1970-1971
- (200) - White [Trim Code PRXW] - 1970 only
- (656) - Brown [Trim Code PRT5] - 1970 only
- (664) - Brown [Trim Codes PRT7, SRT7] - 1971 only
- (666) - Ember Gold [Trim Code PRY3] - 1971 only
- \*\*\*1970 Barracuda, 'Cuda, Gran Coupe Trim Codes - PRX9, PRXW, PRT5
- \*\*\*1971 Barracuda, 'Cuda Trim Codes - SRX9, SRT7
- \*\*\*1971 Gran Coupe Trim Codes - PRX9, PRT7, PRY3



Front Buckets ..... AA70CBL0010(C)  
100.....\$1080/pr. (L3)  
200, 656, 664, 666.....\$1311/pr. (L3)  
\*Molded foam is available for this model. See the "Molded Foam" section in this catalog.

Hardtop Rear Bench (all vinyl)..... AA70CBL0040(C)  
Convertible Rear Bench (all vinyl)..... AA70CBL0050(C)  
(All colors).....\$403/ea.

## 1971 BARRACUDA, 'CUDA & GRAN COUPE "CLOTH STYLE"

This Legendary product features as-original Salt & Pepper cloth inserts with Coachman grain skirts.

**(C) COLOR CODES:**

(816) - Black & Charcoal Salt & Pepper Cloth (812) / Black (100) [Trim Codes P5X9, H5X9]  
 (817) - Black & Orange Salt & Pepper Cloth (814) / Bright Orange (560) [Trim Code H5XV]

\*\*\*Barracuda, 'Cuda Trim Codes - H5X9, H5XV  
 \*\*\*Gran Coupe Trim Code - P5X9



Front Buckets .....	AA71CBC0010(C)
816.....	\$1089/pr. (L4)
817.....	\$1089/pr. (L1)
Hardtop Rear Bench.....	AA71CBC0040(C)
816.....	\$866/pr. (L4)
817.....	\$866/pr. (L1)

## 1970 BARRACUDA & CHALLENGER "DEPUTY" (WITH 'A93' OPTION CODE)

This Legendary product features as-original Ranger grain inserts with Coachman grain skirts.

**(C) COLOR CODES:**

(100) - Black [Trim Code L6X9]  
 (200) - White [Trim Code L6XW]



PHOTO N/A  
 AT TIME OF  
 PRINTING



Front Buckets .....	AA70CJBS010(C)
(All colors).....	\$597/pr.
<i>*Molded foam is available for this model. See the "Molded Foam" section in this catalog.</i>	
Rear Bench.....	AA70CJBS048(C)
(All colors).....	\$403/ea.

## 1970 CHALLENGER R/T & CHALLENGER

This Legendary product features as-original Coachman or Regal grain inserts with Coachman grain skirts.

**(C) COLOR CODES:**

(100) - Black [Trim Code H6X9]  
 (200) - White [Trim Code H6XW]  
 (338) - Bright Blue [Trim Code H6B5]  
 (434) - Green [Trim Code H6F8]  
 (540) - Burnt Orange [Trim Code H6K4]  
 (550) - Red [Trim Code H6E4]  
 (656) - Brown [Trim Code H6T5]

\*Although original dealer albums show Regal grain inserts some 1970 Challengers have been found with identical trim codes, but with Coachman grain inserts.



Front Buckets (Regal inserts) .....	AA70CJS0010(C)
Front Buckets (Coachman inserts).....	AA70CJ00010(C)
(All colors).....	\$597/pr.
<i>*Please specify insert grain at time of order.</i>	
<i>*Molded foam is available for this model. See the "Molded Foam" section in this catalog.</i>	
Rear Bench Htp (Regal inserts).....	AA70CJS0048(C)
Rear Bench Htp (Coachman inserts).....	AA70CJ00048(C)
Rear Bench Conv (Regal inserts).....	AA70CJS0056(C)
Rear Bench Conv (Coachman inserts).....	AA70CJ00056(C)
(All colors).....	\$403/ea.
<i>*Please specify insert grain at time of order.</i>	

## 1970 CHALLENGER R/T, SE & CHALLENGER "CLOTH STYLE"

This Legendary product features as-original Salt & Pepper cloth inserts with Coachman grain skirts.

**(C) COLOR CODES:**

(811) - Black & White Salt & Pepper Cloth (810) / Black (100) [Trim Code H5X9]  
 (815) - Black & Orange Salt & Pepper Cloth (814) / Burnt Orange (540) [Trim Code H5K4]  
 (819) - Black & Blue Salt & Pepper Cloth (818) / Bright Blue (338) [Trim Code H5B5]  
 (823) - Black & Green Salt & Pepper Cloth (820) / Green (434) [Trim Code H5F8]

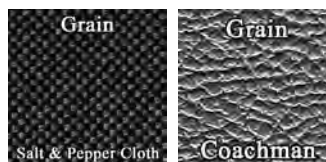

Front Buckets .....	AA70CJC0010(C)
811.....	\$919/pr. (L4)
815, 819, 823.....	\$925/pr. (L1)
<i>*Molded foam is available for this model.</i>	
<i>See the "Molded Foam" section in this catalog.</i>	
Hardtop Rear Bench.....	AA70CJC0040(C)
811.....	\$679/pr. (L4)
815, 819, 823.....	\$681/pr. (L1)



**1970 CHALLENGER R/T, SE & CHALLENGER "LEATHER STYLE"**

*This Legendary product features as-original Leather inserts with Coachman grain skirts.*

- (C) COLOR CODES:**  
 (100) - Black [Trim Code HRX9]  
 (540) - Burnt Orange [Trim Code HRK4]  
 (656) - Brown [Trim Code HRT5]



- Front Buckets ..... **AA70CJL0010(C)**  
**100**..... \$1157/pr. (L3)  
**540, 656** ..... \$1498/pr. (L3)  
*\*Molded foam is available for this model. See the "Molded Foam" section in this catalog.*
- Hardtop Rear Bench (all vinyl)..... **AA70CJL0040(C)**  
 Convertible Rear Bench (all vinyl)..... **AA70CJL0050(C)**  
 (All colors)..... \$403/ea.  
*\*540 Burnt Orange was not available in a convertible model.*

**1971 CHALLENGER R/T & CHALLENGER "LEATHER STYLE"**

*This Legendary product features as-original Leather inserts with Coachman grain skirts.*

- (C) COLOR CODES:**  
 (100) - Black [Trim Code HRX9]



- Front Buckets ..... **AA70CBL0010(C)**  
**100**..... \$1080/pr. (L3)  
*\*Molded foam is available for this model. See the "Molded Foam" section in this catalog.*
- Hardtop Rear Bench (all vinyl)..... **AA70CBL0040(C)**  
 Convertible Rear Bench (all vinyl)..... **AA70CBL0050(C)**  
**100**..... \$403/ea.

**1971 CHALLENGER R/T & CHALLENGER "CLOTH STYLE"**

*This Legendary product features as-original Plaid cloth inserts with Coachman grain skirts.*

- (C) COLOR CODES:**  
 (831) - Black & White Plaid Cloth (830) / Black (100) [Trim Code H5XX]  
 (833) - Yellow & Green Plaid Cloth (872) / Green (434) [Trim Code H5F7]  
 (835) - Black & Orange Plaid Cloth (834) / Black (100) [Trim Code H5X9]

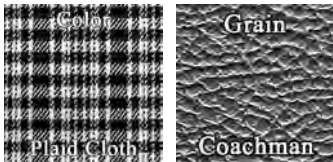

- Front Buckets ..... **AA71CJC0010(C)**  
**831**..... \$980/pr. (L4)  
**833, 835**..... \$1015/pr. (L1)  
*\*Molded foam is available for this model. See the "Molded Foam" section in this catalog.*
- Hardtop Rear Bench..... **AA71CJC0040(C)**  
**831**..... \$658/pr. (L4)  
**833, 835**..... \$681/pr. (L1)

**1971 BARRACUDA, 'CUDA & CHALLENGER "STANDARD STYLE"**

*This Legendary product features as-original El Paso grain inserts with Coachman grain skirts.*

- (C) COLOR CODES:**  
 (100) - Black [Trim Codes H6X9, L6X9]  
 (200) - White [Trim Codes H6XW, L6XW]  
 (340) - Bright Blue [Trim Codes H6B5, L6B5]  
 (452) - Green [Trim Codes H6F7, L6F7]  
 (560) - Orange [Trim Code H6XV]  
 (665) - Tan (668) / Brown (664) [Trim Codes H6T7, L6T7]  
 \*\*\*Barracuda, 'Cuda Trim Codes - H6X9, H6XW, H6B5, H6F7, H6XV, H6T7  
 \*\*\*Challenger Trim Codes - L6X9, L6XW, L6B5, L6F7, L6T7

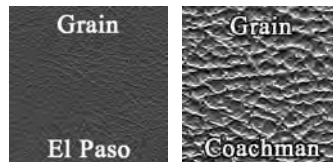

- Front Buckets (without welt)..... **AA71CBJS010(C)**  
 Front Buckets (with welt)..... **AA71CBJSW10(C)**  
 (All colors)..... \$557/pr.  
*\*Please specify with or without small cordwelt around surrounding insert.*
- Hardtop Rear Bench..... **AA71CBJS048(C)**  
 Convertible Rear Bench ..... **AA71CBJS056(C)**  
 (All colors)..... \$403/ea.

**1971 CHALLENGER R/T & CHALLENGER "STANDARD STYLE"**

This Legendary product features as-original Belmont grain inserts with Coachman grain skirts.

**(C) COLOR CODES:**

- (100) - Black [Trim Code H6X9]
- (200) - White [Trim Code H6XW]
- (340) - Bright Blue [Trim Code H6B5]
- (452) - Green [Trim Code H6F7]
- (664) - Brown [Trim Code H6T7]
- (666) - Ember Gold [Trim Code H6Y3]



Front Buckets ..... AA71CBJD010(C)  
 (All colors)..... \$597/pr.  
 \*Molded foam is available for this model. See the "Molded Foam" section in this catalog.

Hardtop Rear Bench..... AA71CBJD048(C)  
 Convertible Rear Bench ..... AA71CBJD056(C)  
 (All colors)..... \$403/ea.

**1972 BARRACUDA, 'CUDA & CHALLENGER**

This Legendary product features as-original Ranger grain inserts with Coachman grain skirts.

**(C) COLOR CODES:**

- (100) - Black [Trim Codes A6X9, B6X9]
  - (200) - White [Trim Codes A6XW, B6XW]
  - (340) - Bright Blue [Trim Codes A6B5, B6B5]
  - (444) - Green [Trim Codes A6F6, B6F6]
  - (666) - Ember Gold [Trim Codes A6Y3, B6Y3]
- \*\*\*Barracuda, 'Cuda Trim Codes - A6X9, A6XW, A6B5, A6F6, A6Y3  
 \*\*\*Challenger Trim Codes - B6X9, B6XW, B6B5, B6F6, B6Y3

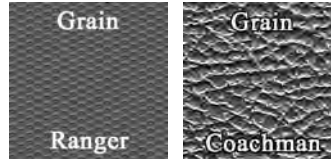

Front Buckets ..... AA72CBJ0010(C)  
 (All colors)..... \$597/pr.

Hardtop Rear Bench..... AA72CBJ0040(C)  
 (All colors)..... \$403/ea.

**1973 BARRACUDA, 'CUDA & CHALLENGER**

This Legendary product features as-original Empire grain inserts with Coachman grain skirts.

**(C) COLOR CODES:**

- (100) - Black [Trim Code A6X9]
- (200) - White [Trim Code A6XW]
- (355) - Dark Blue (342) / Bright Blue (340) [Trim Code A6B5]
- (447) - Light Green (446) / Dark Green (444) [Trim Code A6F6]

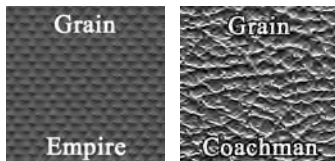

Front Buckets ..... AA73CBJ0010(C)  
 (All colors)..... \$597/pr.  
 \*Molded foam is available for this model. See the "Molded Foam" section in this catalog.

Hardtop Rear Bench..... AA73CBJ0040(C)  
 (All colors)..... \$403/ea.

**1974 BARRACUDA, 'CUDA & CHALLENGER**

This Legendary product features as-original Empire grain inserts with Oxford grain skirts.

**(C) COLOR CODES:**

- (100) - Black [Trim Code A6X9]
- (200) - White [Trim Code A6XW]
- (360) - Lagoon Blue [Trim Code A6B6]
- (450) - Jade Green [Trim Code A6G6]

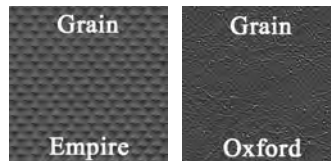

Front Buckets ..... AA74CBJ0010(C)  
 (All colors)..... \$597/pr.  
 \*Molded foam is available for this model. See the "Molded Foam" section in this catalog.

Hardtop Rear Bench..... AA74CBJ0040(C)  
 (All colors)..... \$403/ea.



**1970 BARRACUDA & 'CUDA**

*This Legendary product features as-original Ranger grain inserts with Coachman grain skirts.*

**(C) COLOR CODES:**

- (100) - Black [Trim Code H4X9]
- (200) - White [Trim Codes H4XW, H4BW, H6FW]  
\*H4XW - White w/ Black Carpet  
\*H4BW - White w/ Blue Carpet  
\*H4FW - White w/ Green Carpet
- (338) - Bright Blue [Trim Code H4B5]
- (434) - Green [Trim Code H4F8]



- Front Split Bench with Center Armrest ..... **AA70CB00030(C)**  
**(All colors)**..... \$656/pr.  
*\*Molded foam is available for this model. See the "Molded Foam" section in this catalog.*
- Hardtop Rear Bench..... **AA70CB00048(C)**  
**(All colors)**..... \$403/ea.

**1970 CHALLENGER**

*This Legendary product features as-original Coachman or Regal grain inserts with Coachman grain skirts.*

**(C) COLOR CODES:**

- (100) - Black [Trim Code H6X9]
  - (338) - Bright Blue [Trim Code H6B5]
- \*Although original dealer albums show Regal grain inserts some 1970 Challengers have been found with identical trim codes, but with Coachman grain inserts.*

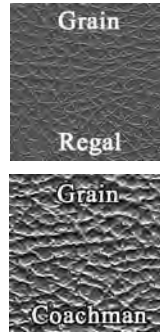

- Front Split Bench with Center Armrest (Regal)..... **AA70CJS0030(C)**
- Front Split Bench with Center Armrest (Coachman)..... **AA70CJ00030(C)**  
**(All colors)**..... \$656/pr.  
*\*Molded foam is available for this model. See the "Molded Foam" section in this catalog.*
- Hardtop Rear Bench (Regal)..... **AA70CJS0048(C)**
- Hardtop Rear Bench (Coachman)..... **AA70CJ00048(C)**  
**(All colors)**..... \$403/ea.

**1971 CHALLENGER**

*This Legendary product features as-original Belmont grain inserts with Coachman grain skirts.*

**(C) COLOR CODES:**

- (100) - Black [Trim Code H4X9]
- (452) - Green [Trim Code H4F7]

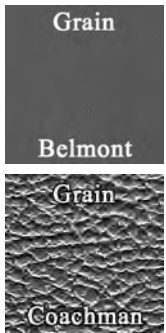

- Front Split Bench with Center Armrest ..... **AA71CBJD030(C)**  
**(All colors)**..... \$656/pr.  
*\*Molded foam is available for this model. See the "Molded Foam" section in this catalog.*
- Hardtop Rear Bench..... **AA71CBJD048(C)**  
**(All colors)**..... \$403/ea.

**1971 BARRACUDA & 'CUDA**

*This Legendary product features as-original El Paso grain inserts with Coachman grain skirts.*

**(C) COLOR CODES:**

- (100) - Black [Trim Code H4X9]
- (200) - White [Trim Code H4XW]
- (340) - Bright Blue [Trim Code H4B5]
- (452) - Green [Trim Code H4F7]
- (665) - Tan (668) / Brown (664) [Trim Code H4T7]



- Front Split Bench with Center Armrest (without welt)..... **AA71CBJS030(C)**
- Front Split Bench with Center Armrest (with welt)..... **AA71CBJSW30(C)**  
**(All colors)**..... \$614/pr.  
*\*Please specify with or without small cordwelt around surrounding insert.*
- Hardtop Rear Bench..... **AA71CBJS048(C)**  
**(All colors)**..... \$403/ea.

**1976 ASPEN, VOLARE & ROADRUNNER**

*This Legendary product features as-original Richmond grain inserts with Oxford grain skirts.*

**(C) COLOR CODES:**

- (108) - Silver (118) / Black (100)** [Trim Code D6X9]
- (215) - Pearl White (215) / White (200)** [Trim Code D6XW, D6BW, D6EW, D6FW]
- \*D6XW - White w/ Black Carpet*
- \*D6BW - White w/ Blue Carpet*
- \*D6EW - White w/ Dark Red Carpet*
- \*D6FW - White w/ Green Carpet*
- (552) - Dark Red (554) / Dark Red (553)** [Trim Code D6E7]

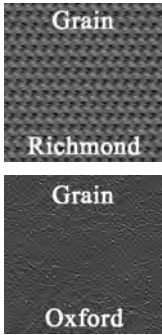

PHOTO N/A  
AT TIME OF  
PRINTING

- Front Buckets ..... **AA76CR00010(C)**
- 108, 215, 552**..... \$1349/ea. (L1)
- \*Customer must reuse decorative buttons*
- Rear Bench..... **AA76CR00048(C)**
- 108, 215, 552**..... \$1057/ea. (L1)
- \*Customer must reuse decorative buttons*

**1977 ASPEN, VOLARE & ROADRUNNER**

*This Legendary product features as-original Shallow Elk grain inserts with Oxford grain skirts.*

**(C) COLOR CODES:**

- (100) - Black** [Trim Code D6X9]
- (200) - White** [Trim Code D6XW, D6BW, D6EW, D6FW]
- \*D6XW - White w/ Black Carpet*
- \*D6BW - White w/ Blue Carpet*
- \*D6EW - White w/ Dark Red Carpet*
- \*D6FW - White w/ Green Carpet*
- (553) - Dark Red** [Trim Code D6E7]



PHOTO N/A  
AT TIME OF  
PRINTING

- Front Buckets ..... **AA77CR00010(C)**
- 100, 200**..... \$574/ea.
- 553**..... \$1345/ea. (L1)
- \*Customer must reuse decorative buttons*
- Rear Bench..... **AA77CR00048(C)**
- 100, 200**..... \$357/ea.
- 553**..... \$1057/ea. (L1)
- \*Customer must reuse decorative buttons*







## 1964-68 DODGE/FARGO A-100 COMPACT VAN & A-100 PICKUP

This Legendary product features as-original heat sealed Bison grain inserts with Bison grain skirts for 1964-1967 models and Coachman grain inserts with Coachman grain skirts for 1968 models.

**(C) COLOR CODES:**  
(100) - Black

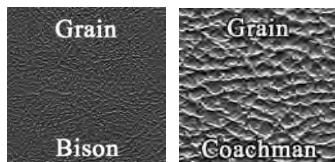

Front Buckets (2" pleat) (1964-67) ..... **AA64CA20010(C)**  
**100** ..... \$545/pr.  
 \*Bucket seat foam is available for this model. See the "Molded Foam" section in this catalog.

Front Buckets (2" pleat) (1968 only) ..... **AA68CA20010(C)**  
**100** ..... \$545/pr.  
 \*Please call for additional color availability.

## 1964-65 DODGE TRUCK CSS "CUSTOM SPORTS SPECIAL"

This Legendary product features as-original heat sealed Bison grain inserts with heat sealed chrome emblem and Bison grain skirts.

**(C) COLOR CODES:**  
(101) - Black with Silver Tinsel welt

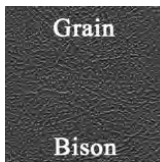

Front Buckets ..... **AA64CL00010(C)**  
**101** ..... \$725/pr.  
 \*Molded foam is available for this model. See the "Molded Foam" section in this catalog.

Front Bucket Seatback Panels ..... **SK64CL00018(C)**  
 (Pre-sewn vinyl panels with new boards)  
**101** ..... \$193/pr.

Console Carpet Kit ..... **CC62CFPR01**  
 (Black 80/20 Loop) ..... \$75/kit

## 1966 DODGE TRUCK CSS "CUSTOM SPORTS SPECIAL"

This Legendary product features as-original Cologne grain inserts and Cologne grain skirts.

**(C) COLOR CODES:**  
(100) - Black

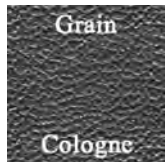

Front Buckets ..... **AA66CL00010(C)**  
**100** ..... \$569/pr.  
 \*Molded foam is available for this model. See the "Molded Foam" section in this catalog.

Console Carpet Kit ..... **CC62CFPR01**  
 (Black 80/20 Loop) ..... \$75/kit

## 1967 DODGE TRUCK CSS "CUSTOM SPORTS SPECIAL"

This Legendary product features as-original heat sealed Cologne grain inserts with Cologne grain skirts.

**(C) COLOR CODES:**  
(100) - Black

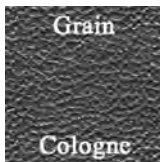

Front Buckets ..... **AA67CL00010(C)**  
**100** ..... \$569/pr.  
 \*Metal emblems *not* included.  
 \*Molded foam is available for this model. See the "Molded Foam" section in this catalog.

Console Carpet Kit ..... **CC62CFPR01**  
 (Black 80/20 Loop) ..... \$75/kit



### 1972-73 DODGE TRUCK D/W SERIES

This Legendary product features as-original heat sealed El Paso grain inserts with Coachman grain skirts for conventional cab models only.

**(C) COLOR CODES:**

- (100) - Black [Trim Code KT1]
- (250) - Parchment [Trim Code KT4]

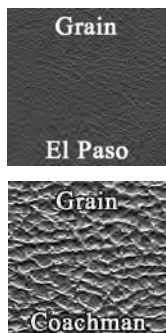

Front Buckets .....	AA73CDT0010(C)
(All colors).....	\$545/pr.
<i>*Metal emblems not included.</i>	
Center Cushion/Armrest .....	CR73CDT0013(C)
(All colors).....	\$142/ea.

### 1974 DODGE TRUCK D/W SERIES

This Legendary product features as-original heat sealed Oxen grain inserts with Oxford grain skirts for conventional cab models only.

**(C) COLOR CODES:**

- (100) - Black [Trim Code KT1]
- (264) - Parchment [Trim Code KT4]



Front Buckets .....	AA74CDT0010(C)
100.....	\$545/pr.
264.....	\$529/pr. (L4)
<i>*Metal emblems not included.</i>	
Center Cushion/Armrest .....	CR74CDT0013(C)
100.....	\$142/ea.
264.....	\$171/ea. (L1)

### 1975 DODGE TRUCK D/W SERIES

This Legendary product features as-original heat sealed Shallow Elk grain inserts with Oxford grain skirts for conventional cab models only.

**(C) COLOR CODES:**

- (100) - Black [Trim Code KT1]
- (267) - Metallic Parchment (266) / Parchment (264) [Trim Code KT4]



Front Buckets .....	AA75CDT0010(C)
100.....	\$545/pr.
267.....	\$788/pr. (L1)
<i>*Metal emblems not included.</i>	
Center Cushion/Armrest .....	CR74CDT0013(C)
100.....	\$142/ea.
264.....	\$171/ea. (L4)

### 1976-79 DODGE TRUCK D/W SERIES

**Models include: 1976-79 POWER WAGON - 1976-79 WARLOCK - 1976-79 MACHO - 1978 MIDNITE EXPRESS & 1978-79 LI'L RED EXPRESS**

This Legendary product features as-original heat sealed Shallow Elk grain inserts with Oxford grain skirts for conventional cab models only.

**(C) COLOR CODES:**

- (100) - Black [Trim Code KT1] - 1976-1979
- (267) - Metallic Parchment / Parchment [Trim Code KT4] - 1976-1977

\*\*\*Trucks originally equipped with bucket seats would have a KB5 code on the Equipment Identification tag located on the hood.



Front Buckets .....	AA76CDT0010(C)
100.....	\$545/pr.
267.....	\$788/pr. (L1)
<i>*Metal emblems not included.</i>	
Center Cushion/Armrest .....	CR76CDT0013(C)
100.....	\$142/ea.
264.....	\$171/ea. (L4)
Back Wall Carpet Kit (Cut-pile)  .....	SK78CDT00210(C)
(All colors).....	\$204/ea.
<i>*Please refer to carpet color selection at time of order.</i>	

**1978 DODGE TRUCK  
D/W SERIES**

**Models include: POWER WAGON & LI'L RED EXPRESS**

*This Legendary product features as-original Diamond Waffle grain inserts with Oxford grain skirts for conventional cab models only.*

**(C) COLOR CODES:**

(100) - Black [Trim Code KT1]  
(548) - Red [Trim Code KT6]



Front Bench..... **AA78CDT0020(C)**  
(All colors)..... \$574/ea.

Back Wall Carpet Kit (Cut-pile) ..... **SK78CDT00210(C)**  
(All colors)..... \$204/ea.  
*\*Please refer to carpet color selection at time of order.*

**1979 DODGE TRUCK  
D/W SERIES**

**Models include: POWER WAGON & LI'L RED EXPRESS**

*This Legendary product features as-original El Paso grain inserts with El Paso grain skirts for conventional cab models only.*

**(C) COLOR CODES:**

(100) - Black [Trim Code KT1]  
(548) - Red [Trim Code KT6]

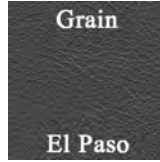

Front Bench..... **AA79CDT0020(C)**  
(All colors)..... \$574/ea.

Back Wall Carpet Kit (Cut-pile) ..... **SK78CDT00210(C)**  
(All colors)..... \$204/ea.  
*\*Please refer to carpet color selection at time of order.*

**Seat Upholstery Installation Kits Are Available  
To Help Complete Your Install!!**

*Seat upholstery Installation Kits from Legendary give you the products you need to do the job yourself!! All components are upholstery grade and have been hand selected by our team of installation experts to provide the highest quality materials available.*

**Check Out the Installation Kits  
Section For More Information**

**\*Right After Seat Upholstery Section**



## SEAT SPRING KITS

### 1962-65 A, B & C-BODY Bucket Seat Top & Bottom Spring Kit

Each kit consists of (4) individual seat top springs and (1) seat bottom spring assembly.

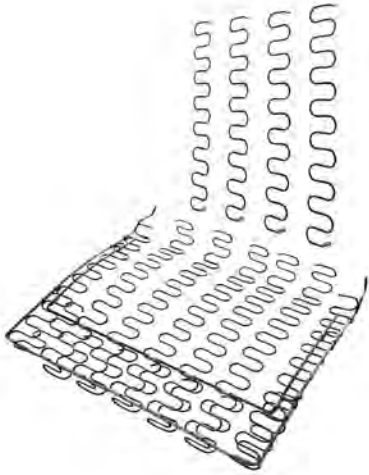

**SA62CABC** ..... \$159.00/kit  
 ☞ (1) Kit does (1) complete bucket seat  
 ☞ (2) Kits must be ordered to do a pair of bucket seats  
 ☞ Sold as a top and bottom kit only

### 1966-67 A & B-BODY Bucket Seat Top & Bottom Spring Kit

Each kit consists of (4) individual seat top springs and (1) seat bottom spring assembly.

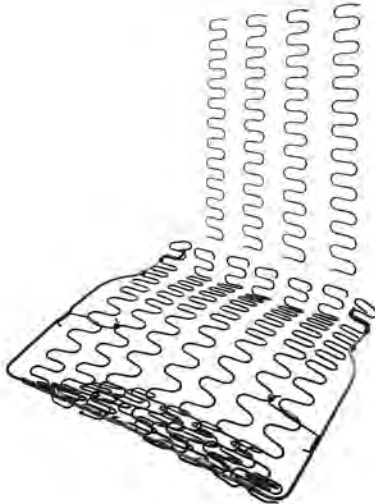

**SA66CAB** ..... \$159.00/kit  
 ☞ (1) Kit does (1) complete bucket seat  
 ☞ (2) Kits must be ordered to do a pair of bucket seats  
 ☞ Sold as a top and bottom kit only

### 1968-69 A & B-BODY Bucket Seat Top & Bottom Spring Kit

Each kit consists of (4) individual seat top springs and (1) seat bottom spring assembly.

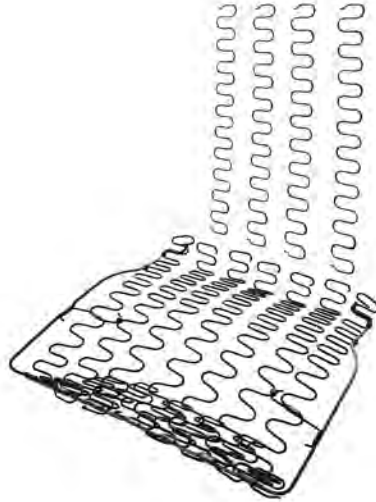

**SA68CAB** ..... \$159.00/kit  
 ☞ (1) Kit does (1) complete bucket seat  
 ☞ (2) Kits must be ordered to do a pair of bucket seats  
 ☞ Sold as a top and bottom kit only

### 1970-71 A, B & E-BODY Bucket Seat Top & Bottom Spring Kit

Each kit consists of (1) seat top spring assembly and (1) seat bottom spring assembly.

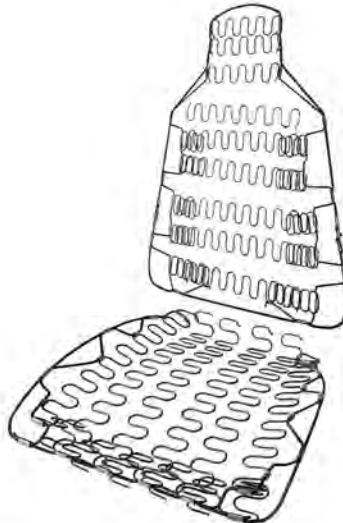

**SA70CABE** ..... \$259.00/kit  
 ☞ (1) Kit does (1) complete bucket seat  
 ☞ (2) Kits must be ordered to do a pair of bucket seats  
 ☞ Sold as a top and bottom kit only

### 1973-76 A-BODY & 1973-74 E-BODY Bucket Seat Bottom Spring Kit

Each kit consists of (4) individual seat bottom springs.



**SA73CAE** ..... \$59.00/kit  
 ☞ (1) Kit does (1) bucket seat bottom  
 ☞ (2) Kits must be ordered to do a pair of bucket seat bottoms

### UNIVERSAL COIL SPRINGS Bench Seat & Rear Seat

Universal coil seat springs used in automotive interiors to absorb shock and give added resilience to the seat. Used in all makes and models dating back to the 1930's.

**NOTE: When choosing an upholstery coil seat spring, measure the overall height when not under pressure.**



**SACOIL4** (4" Tall - 13 Gauge) ..... \$7.00/ea.  
**SACOIL4.5** (4.5" Tall - 13 Gauge) .... \$7.00/ea.  
**SACOIL5** (5" Tall - 12 Gauge) ..... \$7.00/ea.  
**SACOIL5.5** (5.5" Tall - 12 Gauge) .... \$7.00/ea.  
 ☞ Applications Include: Front Split Bench Seats, Front Straight Bench Seats, Hardtop Rear Seats, Sedan/Coupe Rear Seats & Convertible Rear Seats

### 3 3/8" INTERLOCKING SPRING

#### Long Bench Seat & Rear Seat

3 3/8" long spring used in automotive interiors to tie together the coil seat springs which absorb shock and give added resilience to the seat. Used in all makes and models dating back to the 1930's



**SASPRING** ..... \$2.00/ea.  
 ☞ Applications Include: Front Split Bench Seats, Front Straight Bench Seats, Hardtop Rear Seats, Sedan/Coupe Rear Seats & Convertible Rear Seats

## PLASTIC SEATBACK COVERS



Reproduction plastic seat back covers for 1970-72 A & E-Body and 1970-74 B-Body models.

- 1970 A, B, & E-Body (OEM - Injection Molded)**  
**SK70ABE0M18100** (Black)..... \$299.00/pr.  
**SK70ABE0M18200** (White) ..... \$299.00/pr.
- 1971-72 A & E-Body,**  
**1971-74 B-Body (OEM - Injection Molded)**  
**SK71ABE0M18100** (OEM) (Black) ..... \$299.00/pr.  
**SK71ABE0M18200** (OEM) (White)..... \$299.00/pr.

## CENTER ARMREST HINGE WASHER

Side hinge washers made of die-cut polypropylene for bucket seat models with optional center armrest. These washers protect the vinyl from wear when the armrest is folded in the up or down position.

- HG66WASHER** ..... \$ 4.00/pr.

## BUCKET SEAT HINGE WASHER



Black panel board washers help protect the skirts on your upholstery from wear. These washers come in a set of (4) and work for all 1966-74 A, B, C & E-Body bucket seats.

- TAHINGEWASHER** (Set/4)..... \$ 3.00/set

## HINGE COVERS



1968-69 A & B-Body reproduction hinge covers for bucket seat models. Screws included.

- HG68CBLRVWX01** (Black)..... \$59.00/pr.  
**HG68CBLRVWX02** (White) ..... \$59.00/pr.



1973-74 E-Body & 1973-76 A-Body reproduction hinge covers for bucket seat models. Screws included.

- HG73CBJLV01** (Black) ..... \$59.00/pr.  
**HG73CBJLV02** (White) ..... \$59.00/pr.



1970-76 A-Body reproduction hinge covers for bench seat models.

- HG70CLV01** (1970-72) (Black) ..... \$59.00/pr.  
**HG70CLV02** (1970-72) (White)..... \$59.00/pr.  
**HG73CLV01** (1973-76) (Black only)... \$52.00/pr.

## BUCKET SEAT CATCH



Bucket seat catch for 1970-74 A, B & E-Body models locks the front seat top in place and keeps it from falling forward.

- TA70ABE-SEATCTCH**..... \$39.00/pr.

## SEAT SPACER



Reproduction plastic seat spacers for 1966-70 A & B-Body bucket and bench seat models mount on the seat track studs. Use (4) per seat.

- TA66AB-SPACER**..... \$15.00/pk.

## SEAT STOPS



Nylon bumpers for A, B & E-Body models keep the front seat top in its correct upright position. These mount on the backside of the front seat bottoms.

- 1962-65 A & B-Body (Bench)**  
**TA63ABSEATSTOP** (shown)..... \$19.00/pr.
- 1970-72 B & E-Body (Bucket)**  
**TA70ABE-SEATSTOP** ..... \$29.00/pr.  
 \*STUDS INCLUDED

## SEAT BELTS



Universal aftermarket non-retractable replacement seat belts for all models. These belts feature a "flip" release and are available in 60" & 74" lengths. Mounting hardware included. Sold individually, one belt per passenger.

- TNSEATBELT60(C)** (60")..... \$39.00/ea.  
**TNSEATBELT74(C)** (74")..... \$39.00/ea.  
 Please specify color at time of order.

- |                |                 |                 |
|----------------|-----------------|-----------------|
| (01) Black     | (13) Dark Green | (25) Dark Brown |
| (03) Red       | (18) Light Blue | (26) Saddle     |
| (07) Dark Blue | (21) Medium Red | (31) Maroon     |



## SEAT BELT GUIDE



Reproduction seat belt guides for 1970 Barracuda & Challenger models. Includes installation hardware.

**TN70E-SBGUIDE01** .....\$19.00/pr.

## FRONT SHOULDER HARNESS MOUNTING COVER



Reproduction front shoulder harness mounting covers for 1967-70 A & B-Body and 1970-74 E-Body models.

**TN67ABESHOULDER** .....\$49.00/pr.

## HEADREST CHROME BANDS



Replacement chrome bands for molded headrests on 1968-70 A, B & C-Body bucket and bench seat models.

**TACHROMEBAND** .....\$39.00/pr.

## SEAT BELT MOUNTING COVERS

Reproduction seat belt mounting covers for 1967-70 A & B-Body models. Made of rubber, these covers install over the driver and passenger belt that mount to the drive shaft tunnel.

**TN67ABSBMOUNTCOV** .....\$49.00/pr.

## SEAT LATCH RETURN SPRINGS



Seat latch return springs made from 302 stainless, stress relieved steel available for 1968 A, B & C-Body w/ bucket style interiors, 1969 B & C-Body w/ bucket style interiors, 1970 A-Body w/ bucket style interiors & 1970 B-Body w/ bench style interiors.  
\*\*LIMITED QUANTITIES AVAILABLE\*\*

**TN68C-SLRS** .....\$15.00/ea.

## SEATBACK BOARDS

Die-cut seatback panel boards for 1968-69 A & B-Body bucket seats and 1966-72 A & B-Body bench seats. Customer must reuse original clips and bottom edge rails.



**SK68AB00018**  
(\*68-'69 A & B-Body Buckets) .....\$43.00/pr.

**SK70A00018**  
(\*70-'72 A-Body Bench w/ center armrest)....\$43.00/pr.

## SEATBACK KITS



These new 1968-69 seatback kits come pre-assembled with vinyl wrapped new boards and all mounting hardware attached. The mounting hardware consists of 4 metal clips per seatback and one lower curved metal bracket that are stapled onto the boards are original.

**1968 Dodge/Plymouth A & B-Body**  
**SK68AB00018** (All Colors).....\$175.00/pr.  
\*NOT for Barracuda models with Deluxe style bucket seats

**1968 Barracuda w/ Deluxe Style Bucket Seats**  
**SK68CBD0018** (All Colors).....\$175.00/pr.

**1969 Dodge/Plymouth A & B-Body**  
**SK69AB00018** (All Colors).....\$175.00/pr.  
\*NOT for Dart models

**1969 Dart**  
**SK69CL00018** (All Colors).....\$175.00/pr.

## SEATBACK TOP BOARDS





Die-cut seatback top panel boards for 1968-69 A & B-Body bucket seat models.

**SK68ABSEATTOP** .....\$36.00/pr.



# MOLDED FOAM AND FOAM ACCESORIES

 [facebook.com/legendaryautointeriors](https://facebook.com/legendaryautointeriors)  
 [twitter.com/legendaryautoin](https://twitter.com/legendaryautoin)

 [www.legendaryautointeriors.com](http://www.legendaryautointeriors.com)  
 [instagram.com/legendaryautointeriorsltd](https://instagram.com/legendaryautointeriorsltd)  
 [youtube.com/user/legendaryauto](https://youtube.com/user/legendaryauto)

INSTALLATION KITS

**FRONT BUCKET SEATS**  
All 1960-79 Dodge/Chrysler/Plymouth



**INSTALLATION-KIT1** <sup>OS1</sup>.....\$29.00/ea.  
Kit includes: 3 yards of burlap, 30 feet of paper coated listing wire, 2.5 yards of 2 inch wide felt & a dust mask.

**HARDTOP AND CONVERTIBLE REAR SEATS**  
All 1966-74 Dodge/Chrysler/Plymouth



**INSTALLATION-KIT2** <sup>OS1</sup>.....\$279.00/ea.  
Kit includes: (1) 30"x70" 1 1/2" thick foam, (1) 10lb. roll of cotton, 4 yards of burlap, 12 feet of paper coated listing wire, 2 yards of muslin, (1) 3 1/2" x 64" Wire Edge Reinforced Burlap Cotton Support Band & a dust mask.

**SPLIT BENCH & FULL BENCH FRONT SEATS**

All 1962-74 Dodge/Chrysler/Plymouth  
\*With & Without Center Armrest



**INSTALLATION-KIT4** <sup>OS1</sup>.....\$279.00/ea.  
Kit includes: (1) 30"x70" 1 1/2" thick foam, (1) 10lb. roll of cotton, 4 yards of burlap, 12 feet of paper coated listing wire, 2 yards of muslin, 3 yards of 2 inch wide felt, (1) 3 1/2" x 64" Wire Edge Reinforced Burlap Cotton Support Band & a dust mask.

**BUCKET FRONT SEATS**

1965 Coronet, 1966 Satellite, 1966-67 Dart, 1968-69 Barracuda, 1969 Sport Satellite, Roadrunner & GTX



**INSTALLATION-KIT6**.....\$100.00/ea.  
Kit includes: 1" thick foam (8) straight collar pieces

**BUCKET FRONT SEATS CONT.**  
1966-67 Barracuda, 1966 Valiant

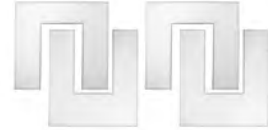

**INSTALLATION-KIT8**.....\$100.00/ea.  
Kit includes: 1" thick foam (4) horseshoe pieces

1968 Dart, Sport Satellite, GTX, 1968-69 Charger



**INSTALLATION-KIT11**.....\$100.00/ea.  
Kit includes: (2) precut front seat bottom and (2) front seat top pieces of 1/2" high density upholstery foam

**HARDTOP AND CONVERTIBLE REAR SEATS**

1962-65 Dodge/Chrysler/Plymouth  
\*With & Without Center Speaker Assembly



**INSTALLATION-KIT12** <sup>OS1</sup>.....\$279.00/ea.  
Kit includes: (1) 30"x70" 1 1/2" thick foam, (1) 10lb. roll of cotton, 4 yards of burlap, 12 feet of paper coated listing wire, 2 yards of muslin, (1) 6" x 64" Wire Edge Reinforced Burlap Cotton Support Band & a dust mask.

**HOG RING PLIER KITS**

Standard Hog Ring Plier Kit  
**TAHOG**.....\$15.00/ea.  
Kit contains pliers and enough hog rings for a front or rear installation only.

Deluxe Hog Ring Plier Kit  
**TAHOGHVY**.....\$39.00/ea.  
Kit contains heavy duty pliers and enough hog rings for a complete front and rear installation.

Hog Rings (Pkg/200)  
**TAHGRING200**.....\$ 5.00/pk.

**INSTALLATION, FOAM & COTTON ACCESSORIES**

Cotton Batting (1 Roll) <sup>OS2</sup>  
**TACOTTONROLL**.....\$ 48.00ea.  
1 Roll consists of 10 lbs.  
Must be used in conjunction with Legendary muslin.

Muslin (1 yard)  
**TAYDMUSLIN**.....\$ 3.00/yd.  
Must be used in conjunction with Legendary cotton batting.

High Density Foam  
**TAFOAM1** (1.5" thick x12" x12").....\$20.00/ea.  
**TAFOAM2** (1.5" thick x 24" x 24").....\$38.00/ea.  
**TAFOAM3** (1.5" thick x 30" x 70") <sup>OS1</sup>.....\$82.00/ea.

Burlap (36" wide)  
**TABURLAP**.....\$ 3.00/yd.

Paper Coated Wire  
**TAPAPERWIRE**.....\$ 2.50/ft.



# Chrysler, Dodge, Plymouth

## 1960-65 A, B & C-BODY BUCKET SEAT FOAM



1960-65 molded foam for all A, B & C-Body models with bucket seats. Sets consist of a pair of (2) front seat tops and (2) front seat bottoms.

**MF60ABCSET**  ..... \$339.00/set  
 ☞ Requires minimal to moderate modification on some models during installation.  
 ☞ Professional installation is highly recommended. Please see our installation services page located in the back of this catalog.  
 ☞ Bucket seat foam will not work for Chrysler 300 rear bucket seats.

## 1966-67 A & B-BODY BUCKET SEAT FOAM



1966-67 molded foam for all A & B-Body models with bucket seats. Sets consist of a pair of (2) front seat tops and (2) front seat bottoms.

**MF66ABSET**  ..... \$339.00/set  
 ☞ Requires minimal to moderate modification on some models during installation.  
 ☞ Professional installation is highly recommended. Please see our installation services page located in the back of this catalog.  
 ☞ Bucket seat foam will not work for 1966-67 Charger rear bucket seats.

## 1968-69 A & B-BODY BUCKET SEAT FOAM



1968-69 molded foam for all A & B -Body models with bucket seats. Sets consist of a pair of (2) front seat tops and (2) front seat bottoms.

**MF68ABSET**  ..... \$339.00/set  
 ☞ Requires minimal to moderate modification on some models during installation.  
 ☞ Professional installation is highly recommended. Please see our installation services page located in the back of this catalog.

## 1970-71 A, B & E-BODY BUCKET SEAT FOAM



1970-71 molded foam for the following A, B, & E-Body models with high-back bucket seats. Sets consist of a pair of (2) front seat tops, (2) front seat bottoms and (2) headrest caps.

1970 'Cuda, Roadrunner, Sport Satellite, GTX & Superbird (vinyl style)  
 1970 Barracuda Gran Coupe (vinyl & cloth style)  
 1970-71 Duster (vinyl style)  
 1971 Demon  
 1971 Challenger (cloth style)

**MF70ABESET**  ..... \$369.00/set  
 ☞ Requires minimal to moderate modification on some models during installation.  
 ☞ Professional installation is highly recommended. Please see our installation services page located in the back of this catalog.



1970-71 E-BODY BUCKET SEAT FOAM



1970-71 molded foam for the following **E-Body models** with high-back bucket seats. Sets consist of a pair of (2) front seat tops, (2) front seat bottoms and (2) headrest caps.

- 1970 Challenger (cloth style)
- 1970 Challenger (leather style)
- 1971 Challenger ("deluxe" vinyl style)

**MF70CJDLSET** OS2 ..... \$369.00/set  
 ☞ Requires minimal to moderate modification on some models during installation.  
 ☞ Professional installation is highly recommended. Please see our installation services page located in the back of this catalog.

1970-71 A & E-BODY BUCKET SEAT FOAM



1970-71 molded foam for the following **A & E-Body models** with high-back bucket seats. Sets consist of a pair of (2) front seat tops, (2) front seat bottoms and (2) headrest caps.

- 1970-71 'Cuda, Barracuda Gran Coupe (leather style)
- 1971 Challenger (leather style)
- 1971 Scamp (vinyl style)
- 1970 Challenger (vinyl style)
- 1971 Dart Swinger (vinyl style)

**MF70CBLJSET** OS2 ..... \$369.00/set  
 ☞ Requires minimal to moderate modification on some models during installation.  
 ☞ Professional installation is highly recommended. Please see our installation services page located in the back of this catalog.

1973-76 A-BODY BUCKET SEAT FOAM



1973-76 molded foam for the following **A-Body models** with high-back bucket seats. Sets consist of a pair of (2) front seat tops, (2) front seat bottoms

- 1973-76 Duster
- 1973-76 Dart Sport
- 1975-76 Dart, Dart Swinger, Scamp

**MF73CLVSET** OS2 ..... \$369.00/set  
 ☞ Requires minimal to moderate modification on some models during installation.  
 ☞ Professional installation is highly recommended. Please see our installation services page located in the back of this catalog

1973-74 E-BODY BUCKET SEAT FOAM



1973-74 molded foam for the following **E-Body models** with high-back bucket seats. Sets consist of a pair of (2) front seat tops, (2) front seat bottoms

- 1973-74 Challenger & Cuda

**MF73CBJSET** OS2 ..... \$369.00/set  
 ☞ Requires minimal to moderate modification on some models during installation.  
 ☞ Professional installation is highly recommended. Please see our installation services page located in the back of this catalog



# Chrysler, Dodge, Plymouth

## 1963-69 A-100 VAN & SUPERSTOCK BUCKET SEAT FOAM

PHOTO N/A  
AT TIME OF  
PRINTING

Molded foam kit for 1963-69 A-100 Van, 1964,65 & 68 Super Stock. Sets consist of a pair of (2) front seat tops and (2) front seat bottoms.

**MF64CSS**  ..... \$369.00/set

 Requires minimal to moderate modification on some models during installation.  
 Professional installation is highly recommended. Please see our installation services page located in the back of this catalog.

## 1970 CUDA SPLIT BENCH W/ CENTER ARM REST





**INSTALLATION-KIT13**  ..... \$337.00/set

 Kit includes: 1 pair of molded foam front seat tops with caps, (1) 30"x70" 1 1/2" thick foam, 4 yards of burlap, 7 yards paper coated listing wire, 2 yards of muslin, 3 yards of 2" wide felt & a dust mask.

## 1970 CHALLENGER SPLIT BENCH W/ CENTER ARM REST



**INSTALLATION-KIT14**  ..... \$337.00/set

 Kit includes: 1 pair of molded foam front seat tops with caps, (1) 30"x70" 1 1/2" thick foam, 4 yards of burlap, 7 yards paper coated listing wire, 2 yards of muslin, 3 yards of 2" wide felt & a dust mask.

## 1971 CHALLENGER SPLIT BENCH W/ CENTER ARM REST



**INSTALLATION-KIT15**  ..... \$337.00/set

 Kit includes: 1 pair of molded foam front seat tops with caps, (1) 30"x70" 1 1/2" thick foam, 4 yards of burlap, 7 yards paper coated listing wire, 2 yards of muslin, 3 yards of 2" wide felt & a dust mask.





# DOOR PANEL AND TRIM ACCESORIES

 [facebook.com/legendaryautointeriors](https://facebook.com/legendaryautointeriors)  
 [twitter.com/legendaryautoin](https://twitter.com/legendaryautoin)

 [www.legendaryautointeriors.com](http://www.legendaryautointeriors.com)  
 [instagram.com/legendaryautointeriorsltd](https://instagram.com/legendaryautointeriorsltd)  
 [youtube.com/user/legendaryauto](https://youtube.com/user/legendaryauto)

**1969-76 DODGE/PLYMOUTH A-BODY**  
**DART, DART CUSTOM, DART SWINGER & SCAMP**  
**"HARDTOP MODELS"**

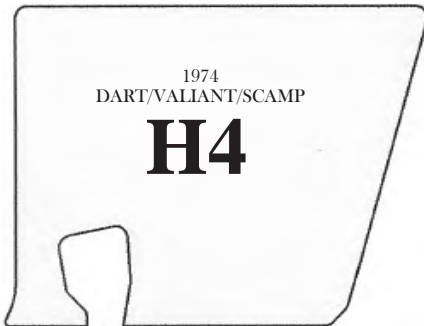

---

**1970-76 DODGE/PLYMOUTH A-BODY**  
**DUSTER, DEMON & DART SPORT**  
**"FASTBACK MODELS"**

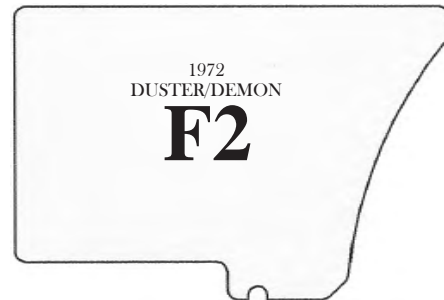
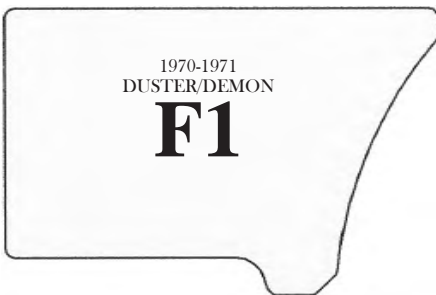

### 1964 DART GT BUCKET STYLE

This Legendary product features as-original Die-electrically heat sealed Bison grain vinyl with carpeted lower section. Special cutout area in filler board to accommodate armrest base. Padded Multi-Level Construction 3-Dimensional Panel.

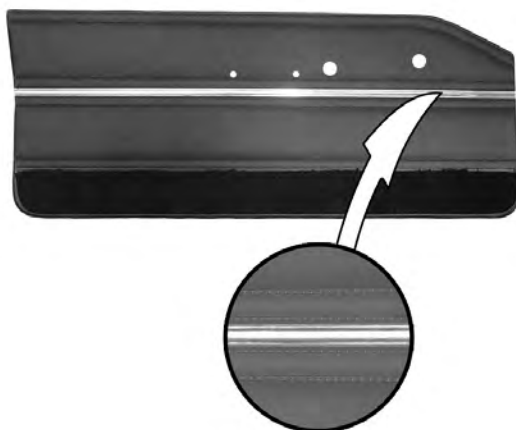

**(C) COLOR CODES:**

- (100) Black
- (308) Dark Metallic Blue
- (408) Dark Metallic Olive Gold
- (510) Crimson Red
- (608) Dark Metallic Brown

Front Panels ..... **DO64CL00010(C)**  
 100, 308, 510 ..... \$502/pr.  
 408, 608 ..... \$933/pr. (L1)  
 ☞ Refer to carpet color selection at time of order.  
 ☞ Customer must reuse original metal trim.  
 ☞ Require (12) door clips per panel.

Hardtop Rear Panels ..... **DO64CL00040(C)**  
 100, 308, 510 ..... \$287/pr.  
 408, 608 ..... \$580/pr. (L1)  
 ☞ Refer to carpet color selection at time of order.  
 ☞ Require (4) door clips per panel.

Convertible Rear Panels ..... **DO64CL00050(C)**  
 100, 308, 510 ..... \$201/pr.  
 408, 608 ..... \$395/pr. (L1)  
 ☞ Refer to carpet color selection at time of order.  
 ☞ Require (4) door clips per panel.

### 1965 DART GT BUCKET STYLE

This Legendary product features as-original Die-electrically heat sealed Cologne grain vinyl with carpeted lower section. Special cutout area in filler board to accommodate armrest base. Padded Multi-Level Construction 3-Dimensional Panel.

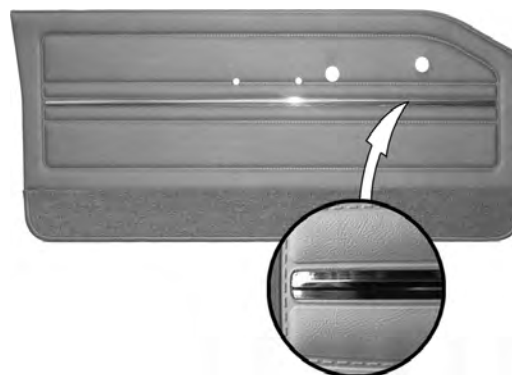
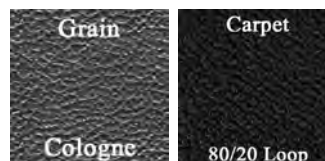

**(C) COLOR CODES:**

- (100) Black
- (202) Pearl White
- (314) Metallic Blue
- (520) Metallic Red
- (610) Metallic Fawn

Front Panels ..... **DO65CL00010(C)**  
 (All colors) ..... \$502/pr.  
 ☞ Refer to carpet color selection at time of order.  
 ☞ Customer must reuse original metal trim.  
 ☞ Require (12) door clips per panel.

Hardtop Rear Panels ..... **DO65CL00040(C)**  
 (All colors) ..... \$287/pr.  
 ☞ Refer to carpet color selection at time of order.  
 ☞ Require (4) door clips per panel.

Convertible Rear Panels ..... **DO65CL00050(C)**  
 (All colors) ..... \$201/pr.  
 ☞ Refer to carpet color selection at time of order.  
 ☞ Require (4) door clips per panel.

### 1966 DART GT BUCKET STYLE

This Legendary product features as-original Die-electrically heat sealed Cologne grain vinyl with carpeted lower section. Special cutout area in filler board to accommodate armrest base. Padded Multi-Level Construction 3-Dimensional Panel.

Front Panels ..... **DO66CL00010(C)**  
 (All colors) ..... \$502/pr.  
 ☞ Refer to carpet color selection at time of order.  
 ☞ Customer must reuse original metal trim.  
 ☞ Require (12) door clips per panel.

Hardtop Rear Panels ..... **DO66CL00040(C)**  
 (All colors) ..... \$287/pr.  
 ☞ Refer to carpet color selection at time of order.  
 ☞ Require (4) door clips per panel.

Convertible Rear Panels ..... **DO66CL00050(C)**  
 (All colors) ..... \$201/pr.  
 ☞ Refer to carpet color selection at time of order.  
 ☞ Require (4) door clips per panel.

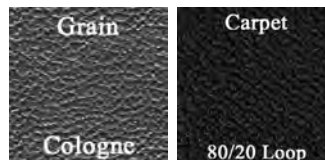
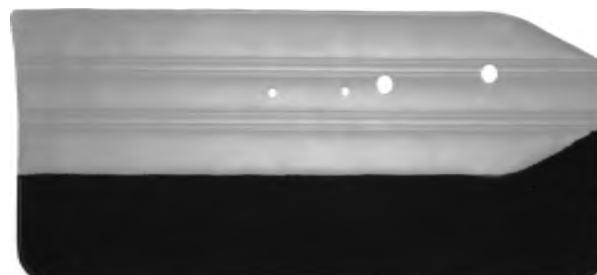

**(C) COLOR CODES:**

- (100) Black
- (202) Pearl White
- (318) Light Metallic Blue
- (505) Red
- (614) Gold (Requires Sample Approval)

### 1967 DART GT BUCKET STYLE

This Legendary product features as-original Die-electrically heat sealed Cologne grain vinyl. Special cutout area in filler board to accommodate armrest base. Padded Multi-Level Construction 3-Dimensional Panel.

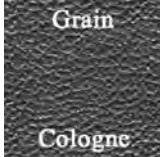
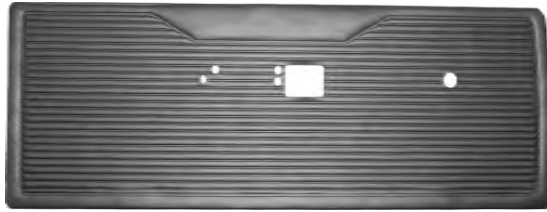

**(C) COLOR CODES:**

- (100) Black
- (202) Pearl White
- (320) Metallic Navy
- (520) Metallic Red
- (620) Copper

Front Panels ..... **DO67CL00010(C)**  
 (All colors) ..... \$461/pr.  
 ⚠ Require (12) door clips per panel.

Hardtop Rear Panels ..... **DO67CL00040(C)**  
 (All colors) ..... \$265/pr.  
 ⚠ Require (4) door clips per panel.

### 1965 VALIANT SIGNET BUCKET STYLE

This Legendary product features as-original Die-electrically heat sealed Bison grain vinyl with chrome accents. Special cutout area in filler board to accommodate armrest base. Padded Multi-Level Construction 3-Dimensional Panel.

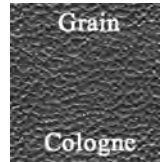

**(C) COLOR CODES:**

- (100) Black
- (314) Metallic Blue
- (520) Metallic Red (Canadian Valiant models only)
- (510) Red
- (610) Metallic Fawn
- (614) Gold

Front Panels ..... **DO65CBV0010(C)**  
 (All colors) ..... \$502/pr.  
 ⚠ Require (12) door clips per panel.

Convertible Rear Panels ..... **DO65CV00050(C)**  
 (All colors) ..... \$228/pr.  
 ⚠ Require (4) door clips per panel.  
 ⚠ Rear panels for Valiant hardtop models not available.

### 1967 VALIANT SIGNET BUCKET & BENCH STYLE

This Legendary product features as-original Die-electrically heat sealed Cologne grain vinyl with Bambino grain upper. Special cutout area in filler board to accommodate armrest base. Padded Multi-Level Construction 3-Dimensional Panel.

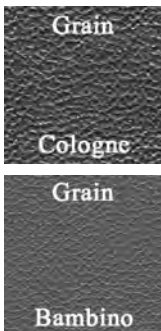

**(C) COLOR CODES:**

- (100) Black w/ Black accent
- (327) Metallic Navy (320) w/ Light Metallic Blue (318) accent
- (421) Dark Met. Turquoise (414) w/ Metallic Turquoise (416) accent
- (520) Metallic Red w/ Metallic Red accent
- (623) Dark Metallic Brown (622) w/ Light Gold (618) accent

Front Panels ..... **DO67CVS0020(C)**  
 100, 327, 421, 520 ..... \$461/pr.  
 623 ..... \$878/pr. (L1)  
 ⚠ Require (12) door clips per panel.

Sedan Rear Panels ..... **DO67CVS0080(C)**  
 100, 327, 421, 520 ..... \$265/pr.  
 623 ..... \$500/pr. (L1)  
 ⚠ Require (4) door clips per panel.

### 1967-68 DART, 1967 "CANADIAN" VALIANT & 1968 VALIANT 100 BENCH STYLE

This Legendary product features as-original Die-electrically heat sealed Cologne grain vinyl with carpeted lower section. Special cutout area in filler board to accommodate armrest base. Padded Multi-Level Construction 3-Dimensional Panel.

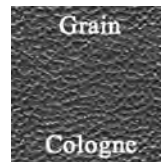

**(C) COLOR CODES:**

- (100) Black (68)
- (318) Light Metallic Blue (67)
- (332) Light Metallic Blue (68)
- (520) Metallic Red (67)
- (618) Light Gold (67)
- (634) Light Metallic Fawn (68)

Front Panels (Dart/Valiant models) ..... **DO67CLV0020(C)**  
 100, 318, 332, 520, 634 ..... \$461/pr.  
 618 ..... \$710/pr. (L1)  
 ⚠ Require (12) door clips per panel.

Sedan Rear Panels (Dart models) ..... **DO67CL00080(C)**  
 Sedan Rear Panels (Valiant models) ..... **DO67CV00080(C)**  
 100, 318, 332, 520, 634 ..... \$265/pr.  
 618 ..... \$415/pr. (L1)  
 ⚠ Require (4) door clips per panel.



## 1968 DART GT & DART GTS BUCKET STYLE

This Legendary product features as-original Die-electrically heat sealed Ascot grain vinyl. Special cutout area in filler board to accommodate armrest base. Padded Multi-Level Construction 3-Dimensional Panel.

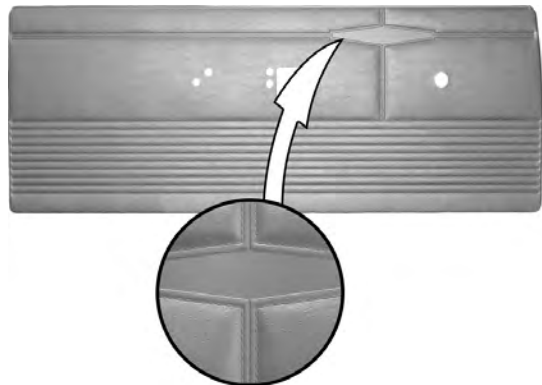

**(C) COLOR CODES:**

- (100) Black
- (202) Pearl White
- (332) Light Metallic Blue
- (432) Dark Metallic Green
- (520) Metallic Red
- (636) Ember Gold

Front Panels ..... **DO68CL00010(C)**  
 (All colors)..... \$461/pr.  
 ⚠ Require (12) door clips per panel.

Hardtop Rear Panels ..... **DO68CL00040(C)**  
 (All colors)..... \$265/pr.  
 ⚠ Require (4) door clips per panel.

## 1968 DART 270 & DART SUPER STOCK BENCH & "SUPER STOCK" BUCKET STYLE

This Legendary product features as-original Die-electrically heat sealed Cologne grain vinyl. Special cutout area in filler board to accommodate armrest base. Padded Multi-Level Construction 3-Dimensional Panel.

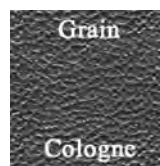

**(C) COLOR CODES:**

- (100) Black
- (202) Pearl White
- (330) Dark Metallic Blue
- (332) Light Metallic Blue
- (432) Light Metallic Green
- (520) Metallic Red
- (632) Dark Fawn
- (634) Light Metallic Fawn

Front Panels ..... **DO68CL00020(C)**  
 100, 202, 330, 332, 432, 520, 634 ..... \$461/pr.  
 632.....\$812/pr. (L1)

⚠ Require (12) door clips per panel.  
 ⚠ 332 Light Metallic Blue and 634 Light Metallic Fawn for Superstock models only.

Hardtop Rear Panels ..... **DO68CL00080(C)**  
 100, 202, 330, 332, 432, 520, 634 ..... \$265/pr.  
 632.....\$484/pr. (L1)

⚠ Require (4) door clips per panel.  
 ⚠ 332 Light Metallic Blue and 634 Light Metallic Fawn for Superstock models only.

## 1969 DART GT & DART GTS BUCKET STYLE

This Legendary product features as-original Die-electrically heat sealed Dakota grain vinyl. Special cutout area in filler board to accommodate armrest base. Padded Multi-Level Construction 3-Dimensional Panel.

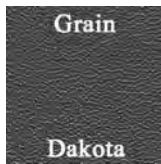

**(C) COLOR CODES:**

- (100) Black
- (202) Pearl White
- (332) Light Metallic Blue
- (432) Light Metallic Green
- (507) Red
- (630) Gold

Front Panels ..... **DO69CL00012(C)**  
 (All colors) ..... \$461/pr.  
 ⚠ Require (12) door clips per panel.

Hardtop Rear Panels ..... **DO69CL00048(C)**  
 (All colors)..... \$265/pr.  
 ⚠ Require (4) door clips per panel.

## 1969 DART CUSTOM BENCH STYLE

This Legendary product features as-original Die-electrically heat sealed Coachman grain vinyl. Special cutout area in filler board to accommodate armrest base. Padded Multi-Level Construction 3-Dimensional Panel.

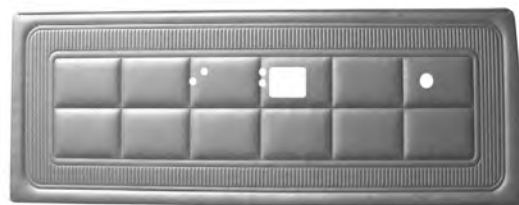

**(C) COLOR CODES:**

- (100) Black
- (200) White
- (332) Light Metallic Blue
- (432) Light Metallic Green
- (528) Red
- (650) Saddle

Front Panels ..... **DO69CLU0020(C)**  
 (All colors) ..... \$461/pr.  
 ⚠ Require (12) door clips per panel.

Hardtop Rear Panels ..... **DO69CLU0080(C)**  
 (All colors)..... \$265/pr.  
 ⚠ Require (4) door clips per panel.



# Chrysler, Dodge, Plymouth

## 1970 DART CUSTOM, DART SWINGER & DART GT BUCKET & BENCH STYLE

This Legendary product features as-original Die-electrically heat sealed Coachman grain vinyl. Special cutout area in filler board to accommodate armrest base. Padded Multi-Level Construction 3-Dimensional Panel.



**(C) COLOR CODES:**

- (100) Black
- (200) White
- (332) Light Metallic Blue
- (432) Light Metallic Green
- (656) Brown

Front Panels ..... **DO70CL00012(C)**  
 (All colors) ..... \$461/pr.  
 ☞ Require (12) door clips per panel.

Hardtop Rear Panels ..... **DO70CL00048(C)**  
 (All colors) ..... \$265/pr.  
 ☞ Require (4) door clips per panel.

## 1969-70 DART SWINGER, SWINGER 340 & 1969 VALIANT 100 BENCH STYLE

This Legendary product features as-original Die-electrically heat sealed Coachman grain vinyl. Special cutout area in filler board to accommodate armrest base. Padded Multi-Level Construction 3-Dimensional Panel.



**(C) COLOR CODES:**

- (100) Black (69-70)
- (332) Light Metallic Blue (69-70)
- (432) Light Metallic Green (70)
- (650) Saddle (69)
- (656) Brown (70)

Front Panels ..... **DO69CLV0012(C)**  
 (All colors) ..... \$461/pr.  
 ☞ Require (12) door clips per panel.

Hardtop Rear Panels ..... **DO69CLV0048(C)H1**  
 (All colors) ..... \$265/pr.  
 ☞ Please verify door panel shape "H1" is correct for your year model.  
 ☞ Require (4) door clips per panel.

*\*IF ORDERING REAR PANELS, PLEASE VERIFY DOOR PANEL SHAPE IN THIS CATALOG. IF YOUR YEAR/MODEL HAS A DIFFERENT SHAPE/STYLE REAR PANEL THAN OFFERED, PLEASE CALL FOR ASSISTANCE.*

## 1971 DART SWINGER, DART GT & SCAMP BUCKET & BENCH STYLE

This Legendary product features as-original Die-electrically heat sealed Coachman grain vinyl. Special cutout area in filler board to accommodate armrest base. Padded Multi-Level Construction 3-Dimensional Panel.



**(C) COLOR CODES:**

- (100) Black
- (200) White
- (332) Light Metallic Blue
- (432) Light Metallic Green
- (666) Ember Gold

Front Panels ..... **DO71CLV0012(C)**  
 (All colors) ..... \$461/pr.  
 ☞ Require (12) door clips per panel.

Hardtop Rear Panels ..... **DO71CLV0048(C)H1**  
 (All colors) ..... \$265/pr.  
 ☞ Please verify door panel shape "H1" is correct for your year model.  
 ☞ Require (4) door clips per panel.

*\*IF ORDERING REAR PANELS, PLEASE VERIFY DOOR PANEL SHAPE IN THIS CATALOG. IF YOUR YEAR/MODEL HAS A DIFFERENT SHAPE/STYLE REAR PANEL THAN OFFERED, PLEASE CALL FOR ASSISTANCE.*

## 1972 DART SWINGER & SCAMP BENCH STYLE

This Legendary product features as-original Die-electrically heat sealed Coachman grain vinyl. Special cutout area in filler board to accommodate armrest base. Padded Multi-Level Construction 3-Dimensional Panel.

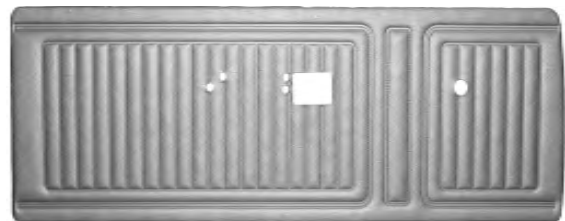

**(C) COLOR CODES:**

- (100) Black
- (200) White
- (340) Bright Blue
- (444) Dark Green
- (666) Ember Gold

Front Panels ..... **DO72CLS0012(C)**  
 (All colors) ..... \$461/pr.  
 ☞ Require (12) door clips per panel.

Hardtop Rear Panels ..... **DO72CLS0048(C)H2**  
 (All colors) ..... \$265/pr.  
 ☞ Please verify door panel shape "H2" is correct for your year model.  
 ☞ Require (7) door clips per panel.

*\*IF ORDERING REAR PANELS, PLEASE VERIFY DOOR PANEL SHAPE IN THIS CATALOG. IF YOUR YEAR/MODEL HAS A DIFFERENT SHAPE/STYLE REAR PANEL THAN OFFERED, PLEASE CALL FOR ASSISTANCE.*



## 1972 DART SWINGER & SCAMP BENCH STYLE

This Legendary product features as-original Die-electrically heat sealed Coachman grain vinyl with woodgrain and chrome accents. Special cutout area in filler board to accommodate armrest base. Padded Multi-Level Construction 3-Dimensional Panel.

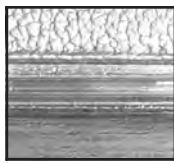
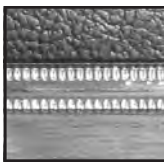
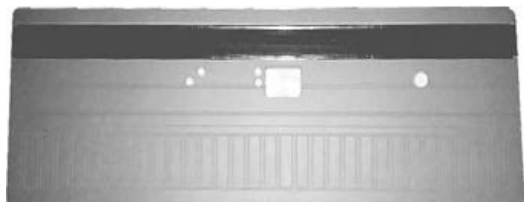

**(C) COLOR CODES:**

- (100) Black
- (200) White
- (340) Bright Blue
- (444) Dark Green
- (666) Ember Gold

Front Panels (Smooth Chrome).....	<b>DO72CLD0012(C)</b>
Front Panels (Knurled Chrome).....	<b>DO72CLDK012(C)</b>
(All colors).....	\$482/pr.

☞ Require (12) door clips per panel.

Hardtop Rear Panels (Smooth Chrome).....	<b>DO72CLD0048(C)H2</b>
Hardtop Rear Panels (Knurled Chrome).....	<b>DO72CLDK048(C)H2</b>
(All colors).....	\$276/pr.

☞ Please verify door panel shape "H2" is correct for your year model.

☞ Require (7) door clips per panel.

\*IF ORDERING REAR PANELS, PLEASE VERIFY DOOR PANEL SHAPE IN THIS CATALOG. IF YOUR YEAR/MODEL HAS A DIFFERENT SHAPE/STYLE REAR PANEL THAN OFFERED, PLEASE CALL FOR ASSISTANCE.

## 1973 DART SWINGER & SCAMP BENCH STYLE

This Legendary product features as-original Die-electrically heat sealed Coachman grain vinyl. Special cutout area in filler board to accommodate armrest base. Padded Multi-Level Construction 3-Dimensional Panel.



**(C) COLOR CODES:**

- (100) Black
- (250) Parchment
- (340) Bright Blue
- (444) Dark Green
- (672) Honey Gold

Front Panels.....	<b>DO73CLV0012(C)</b>
100, 250, 340, 444.....	\$461/pr.
672.....	\$888/pr. (L4)

☞ Require (12) door clips per panel.

Hardtop Rear Panels.....	<b>DO73CLV0048(C)H3</b>
100, 250, 340, 444.....	\$265/pr.
672.....	\$559/pr. (L1)

☞ Please verify door panel shape "H3" is correct for your year model.

☞ Require (8) door clips per panel.

\*IF ORDERING REAR PANELS, PLEASE VERIFY DOOR PANEL SHAPE IN THIS CATALOG. IF YOUR YEAR/MODEL HAS A DIFFERENT SHAPE/STYLE REAR PANEL THAN OFFERED, PLEASE CALL FOR ASSISTANCE.

## 1973 DART SWINGER & SCAMP BENCH STYLE

This Legendary product features as-original Die-electrically heat sealed Coachman grain vinyl with woodgrain and chrome accents. Special cutout area in filler board to accommodate armrest base. Padded Multi-Level Construction 3-Dimensional Panel.

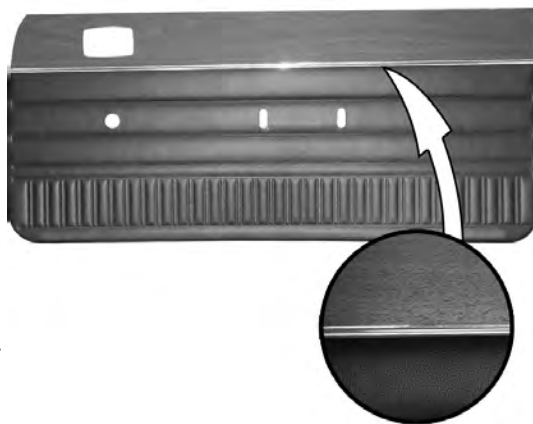

**(C) COLOR CODES:**

- (100) Black
- (250) Parchment
- (340) Bright Blue
- (444) Dark Green
- (672) Honey Gold

Front Panels.....	<b>DO73CLVW012(C)</b>
100, 250, 340, 444.....	\$502/pr.
672.....	\$855/pr. (L1)

☞ Require (12) door clips per panel.

Hardtop Rear Panels.....	<b>DO73CLVW048(C)H3</b>
100, 250, 340, 444.....	\$287/pr.
672.....	\$532/pr. (L1)

☞ Please verify door panel shape "H3" is correct for your year model.

☞ Require (8) door clips per panel.

\*IF ORDERING REAR PANELS, PLEASE VERIFY DOOR PANEL SHAPE IN THIS CATALOG. IF YOUR YEAR/MODEL HAS A DIFFERENT SHAPE/STYLE REAR PANEL THAN OFFERED, PLEASE CALL FOR ASSISTANCE.

## 1974 DART SWINGER & SCAMP BENCH STYLE

This Legendary product features as-original Die-electrically heat sealed Oxford grain vinyl. Special cutout area in filler board to accommodate armrest base. Padded Multi-Level Construction 3-Dimensional Panel.

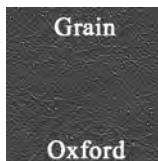

**(C) COLOR CODES:**

- (100) Black
- (200) White
- (264) Parchment
- (360) Lagoon Blue
- (450) Jade Green
- (680) Ember Gold

Front Panels.....	<b>DO74CLVN012(C)</b>
100, 200, 360, 450.....	\$461/pr.
264.....	\$858/pr. (L4)
680.....	\$786/pr. (L1)

☞ Require (12) door clips per panel.

Hardtop Rear Panels.....	<b>DO74CLV0048(C)H4</b>
100, 200, 360, 450.....	\$287/pr.
264.....	\$539/pr. (L4)
680.....	\$545/pr. (L1)

☞ Please verify door panel shape "H4" is correct for your year model.

☞ Require (8) door clips per panel.

\*IF ORDERING REAR PANELS, PLEASE VERIFY DOOR PANEL SHAPE IN THIS CATALOG. IF YOUR YEAR/MODEL HAS A DIFFERENT SHAPE/STYLE REAR PANEL THAN OFFERED, PLEASE CALL FOR ASSISTANCE.

# Chrysler, Dodge, Plymouth

## 1974 DART SWINGER & SCAMP BENCH STYLE

This Legendary product features as-original Die-electrically heat sealed Oxford grain vinyl with woodgrain and chrome accents. Special cutout area in filler board to accommodate armrest base. Padded Multi-Level Construction 3-Dimensional Panel.

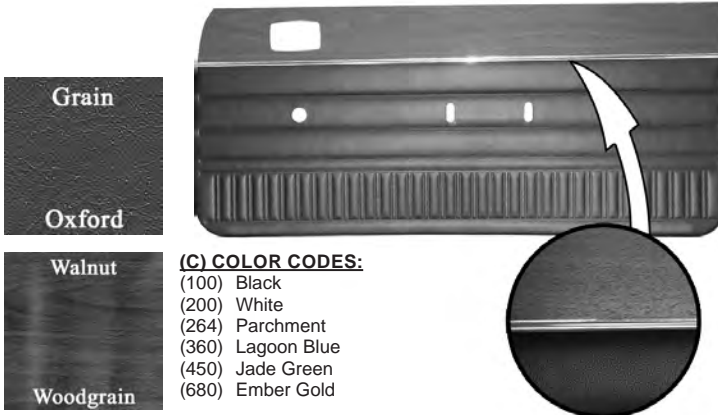

**(C) COLOR CODES:**

- (100) Black
- (200) White
- (264) Parchment
- (360) Lagoon Blue
- (450) Jade Green
- (680) Ember Gold

Front Panels .....	<b>DO74CLVW012(C)</b>
100, 200, 360, 450.....	\$502/pr.
264.....	\$851/pr. (L4)
680.....	\$855/pr. (L1)

☞ Require (12) door clips per panel.

Hardtop Rear Panels .....	<b>DO74CLVW048(C)H4</b>
100, 200, 360, 450.....	\$287/pr.
264.....	\$516/pr. (L4)
680.....	\$520/pr. (L1)

☞ Please verify door panel shape "H4" is correct for your year model.  
☞ Require (8) door clips per panel.

\*IF ORDERING REAR PANELS, PLEASE VERIFY DOOR PANEL SHAPE IN THIS CATALOG. IF YOUR YEAR/MODEL HAS A DIFFERENT SHAPE/STYLE REAR PANEL THAN OFFERED, PLEASE CALL FOR ASSISTANCE.

## 1975-76 DART SWINGER & SCAMP BENCH STYLE

This Legendary product features as-original Die-electrically heat sealed Oxford grain vinyl. Special cutout area in filler board to accommodate armrest base. Padded Multi-Level Construction 3-Dimensional Panel.

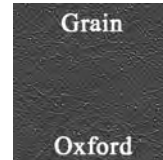

**(C) COLOR CODES:**

- (100) Black
- (200) White
- (264) Parchment
- (360) Lagoon Blue
- (450) Jade Green
- (453) Light Metallic Green
- (680) Ember Gold

Front Panels .....	<b>DO74CLVN012(C)</b>
100, 200, 360, 450.....	\$461/pr.
264.....	\$858/pr. (L4)
453, 680.....	\$786/pr. (L1)

☞ Require (12) door clips per panel.

Hardtop Rear Panels .....	<b>DO75CLV0048(C)H5</b>
100, 200, 360, 450.....	\$287/pr.
264.....	\$516/pr. (L4)
453, 680.....	\$520/pr. (L1)

☞ Please verify door panel shape "H5" is correct for your year model.  
☞ Require (8) door clips per panel.

\*IF ORDERING REAR PANELS, PLEASE VERIFY DOOR PANEL SHAPE IN THIS CATALOG. IF YOUR YEAR/MODEL HAS A DIFFERENT SHAPE/STYLE REAR PANEL THAN OFFERED, PLEASE CALL FOR ASSISTANCE.

## 1975-76 DART SWINGER & SCAMP BUCKET & BENCH STYLE

This Legendary product features as-original Die-electrically heat sealed Oxford grain vinyl with woodgrain and chrome accents. Special cutout area in filler board to accommodate armrest base. Padded Multi-Level Construction 3-Dimensional Panel.



**(C) COLOR CODES:**

- (100) Black
- (200) White
- (264) Parchment
- (360) Lagoon Blue
- (450) Jade Green
- (453) Light Metallic Green
- (680) Ember Gold

Front Panels .....	<b>DO74CLVW012(C)</b>
100, 200, 360, 450.....	\$502/pr.
264.....	\$851/pr. (L4)
453, 680.....	\$855/pr. (L1)

☞ Require (12) door clips per panel.

Hardtop Rear Panels .....	<b>DO75CLVW048(C)H5</b>
100, 200, 360, 450.....	\$287/pr.
264.....	\$516/pr. (L4)
453, 680.....	\$520/pr. (L1)

☞ Please verify door panel shape "H5" is correct for your year model.  
☞ Require (8) door clips per panel.

\*IF ORDERING REAR PANELS, PLEASE VERIFY DOOR PANEL SHAPE IN THIS CATALOG. IF YOUR YEAR/MODEL HAS A DIFFERENT SHAPE/STYLE REAR PANEL THAN OFFERED, PLEASE CALL FOR ASSISTANCE.

## 1970 DUSTER & DUSTER 340 BUCKET & BENCH STYLE

This Legendary product features as-original Die-electrically heat sealed Coachman grain vinyl. Special cutout area in filler board to accommodate armrest base. Padded Multi-Level Construction 3-Dimensional Panel.

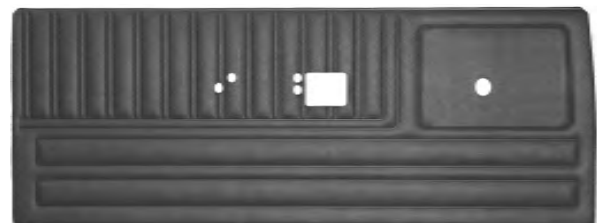

**(C) COLOR CODES:**

- (100) Black
- (330) Dark Metallic Blue
- (434) Dark Metallic Green

Front Panels .....	<b>DO70CLD0012(C)</b>
(All colors).....	\$461/pr.

☞ Require (12) door clips per panel.

Fastback Rear Panels .....	<b>DO70CLD0048(C)F1</b>
(All colors).....	\$265/pr.

☞ Please verify door panel shape "F1" is correct for your year model.  
☞ Require (4) door clips per panel.

\*IF ORDERING REAR PANELS, PLEASE VERIFY DOOR PANEL SHAPE IN THIS CATALOG. IF YOUR YEAR/MODEL HAS A DIFFERENT SHAPE/STYLE REAR PANEL THAN OFFERED, PLEASE CALL FOR ASSISTANCE.



### 1970 DUSTER & DUSTER 340 BUCKET & BENCH STYLE

This Legendary product features as-original Die-electrically heat sealed Coachman grain and chrome accents. Special cutout area in filler board to accommodate armrest base. Padded Multi-Level Construction 3-Dimensional Panel.

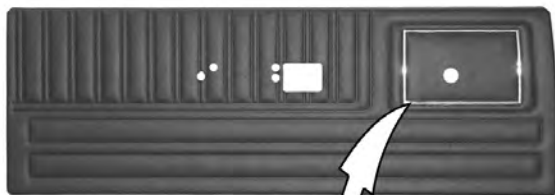

**(C) COLOR CODES:**

- (100) Black
- (200) White
- (330) Dark Metallic Blue
- (434) Dark Metallic Green
- (550) Red
- (656) Brown



Front Panels ..... **DO70CLDC012(C)**  
 (All colors)..... \$482/pr.  
 ☞ Require (12) door clips per panel.

Fastback Rear Panels ..... **DO70CLD0048(C)F1**  
 (All colors)..... \$265/pr.  
 ☞ Please verify door panel shape "F1" is correct for your year model.  
 ☞ Require (4) door clips per panel.

\*IF ORDERING REAR PANELS, PLEASE VERIFY DOOR PANEL SHAPE IN THIS CATALOG.IF YOUR YEAR/MODEL HAS A DIFFERENT SHAPE/STYLE REAR PANEL THAN OFFERED, PLEASE CALL FOR ASSISTANCE.

### 1970 DUSTER & DUSTER 340 BUCKET & BENCH STYLE

This Legendary product features as-original Die-electrically heat sealed Coachman grain vinyl with woodgrain and chrome accent. Special cutout area in filler board to accommodate armrest base. Padded Multi-Level Construction 3-Dimensional Panel.

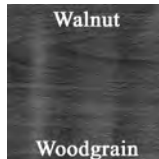

**(C) COLOR CODES:**

- (100) Black
- (200) White
- (330) Dark Metallic Blue
- (434) Dark Metallic Green
- (550) Red
- (656) Brown

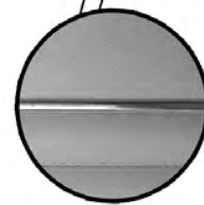

Front Panels ..... **DO70CLDW012(C)**  
 (All colors)..... \$482/pr.  
 ☞ Require (12) door clips per panel.

Fastback Rear Panels ..... **DO70CLD0048(C)F1**  
 (All colors)..... \$265/pr.  
 ☞ Please verify door panel shape "F1" is correct for your year model.  
 ☞ Require (4) door clips per panel.

\*IF ORDERING REAR PANELS, PLEASE VERIFY DOOR PANEL SHAPE IN THIS CATALOG.IF YOUR YEAR/MODEL HAS A DIFFERENT SHAPE/STYLE REAR PANEL THAN OFFERED, PLEASE CALL FOR ASSISTANCE.

### 1971 DUSTER, DUSTER 340, DEMON & DEMON 340 BUCKET & BENCH STYLE

This Legendary product features as-original Die-electrically heat sealed Coachman grain vinyl. Special cutout area in filler board to accommodate armrest base. Padded Multi-Level Construction 3-Dimensional Panel.

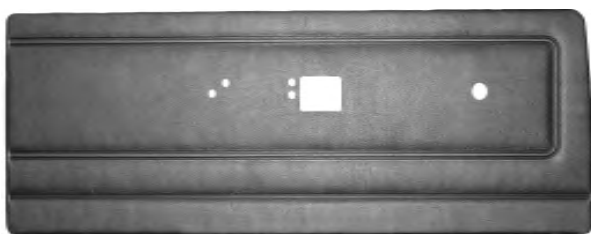

**(C) COLOR CODES:**

- (100) Black
- (330) Dark Metallic Blue
- (452) Dark Metallic Green
- (560) Bright Orange
- (664) Brown
- (666) Ember Gold

Front Panels ..... **DO71CLS0012(C)**  
 (All colors)..... \$437/pr.  
 ☞ Require (12) door clips per panel.

Fastback Rear Panels ..... **DO71CLS0048(C)F1**  
 (All colors)..... \$242/pr.  
 ☞ Please verify door panel shape "F1" is correct for your year model.  
 ☞ Require (4) door clips per panel.

\*IF ORDERING REAR PANELS, PLEASE VERIFY DOOR PANEL SHAPE IN THIS CATALOG.IF YOUR YEAR/MODEL HAS A DIFFERENT SHAPE/STYLE REAR PANEL THAN OFFERED, PLEASE CALL FOR ASSISTANCE.

### 1971 DUSTER, DUSTER 340, DEMON & DEMON 340 BUCKET & BENCH STYLE

This Legendary product features as-original Die-electrically heat sealed Coachman grain vinyl with woodgrain and chrome accents. Special cutout area in filler board to accommodate armrest base. Padded Multi-Level Construction 3-Dimensional Panel.

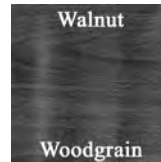
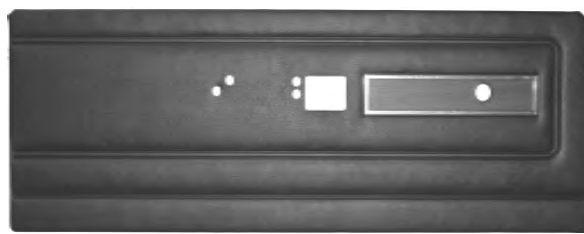

**(C) COLOR CODES:**

- (100) Black
- (330) Dark Metallic Blue
- (452) Dark Metallic Green
- (560) Bright Orange
- (664) Brown
- (666) Ember Gold

Front Panels ..... **DO71CLD0012(C)**  
 (All colors)..... \$482/pr.  
 ☞ Require (12) door clips per panel.

Fastback Rear Panels ..... **DO71CLD0048(C)F1**  
 (All colors)..... \$265/pr.  
 ☞ Please verify door panel shape "F1" is correct for your year model.  
 ☞ Require (4) door clips per panel.

\*IF ORDERING REAR PANELS, PLEASE VERIFY DOOR PANEL SHAPE IN THIS CATALOG.IF YOUR YEAR/MODEL HAS A DIFFERENT SHAPE/STYLE REAR PANEL THAN OFFERED, PLEASE CALL FOR ASSISTANCE.

# Chrysler, Dodge, Plymouth

## 1972 DUSTER, DUSTER 340, DEMON & DEMON 340 BUCKET & BENCH STYLE

This Legendary product features as-original Die-electrically heat sealed Coachman grain vinyl. Special cutout area in filler board to accommodate armrest base. Padded Multi-Level Construction 3-Dimensional Panel.

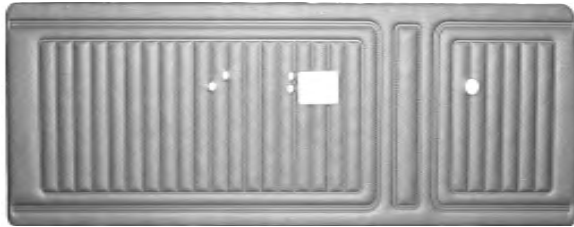

**(C) COLOR CODES:**

- (100) Black
- (200) White
- (340) Bright Blue
- (444) Dark Green
- (666) Ember Gold

Front Panels ..... **DO72CLS0012(C)**  
 (All colors)..... \$461/pr.  
 ☞ Require (12) door clips per panel.

Hardtop Rear Panels ..... **DO72CLS0048(C)F2**  
 (All colors)..... \$265/pr.  
 ☞ Please verify door panel shape "F2" is correct for your year model.  
 ☞ Require (7) door clips per panel.

\*IF ORDERING REAR PANELS, PLEASE VERIFY DOOR PANEL SHAPE IN THIS CATALOG. IF YOUR YEAR/MODEL HAS A DIFFERENT SHAPE/STYLE REAR PANEL THAN OFFERED, PLEASE CALL FOR ASSISTANCE.

## 1973 DUSTER, DUSTER 340, & DART SPORT BUCKET & BENCH STYLE

This Legendary product features as-original Die-electrically heat sealed Coachman grain vinyl. Special cutout area in filler board to accommodate armrest base. Padded Multi-Level Construction 3-Dimensional Panel.



**(C) COLOR CODES:**

- (100) Black
- (200) White
- (250) Parchment
- (340) Bright Blue
- (444) Dark Green
- (672) Honey Gold

Front Panels ..... **DO73CLV0012(C)**  
 100, 200, 250, 340, 444..... \$461/pr.  
 672..... \$888/pr. (L4)  
 ☞ Require (12) door clips per panel.

Hardtop Rear Panels ..... **DO73CLV0070(C)F3**  
 100, 200, 250, 340, 444..... \$265/pr.  
 672..... \$559/pr. (L1)  
 ☞ Please verify door panel shape "F3" is correct for your year model.  
 ☞ Require (8) door clips per panel.

\*IF ORDERING REAR PANELS, PLEASE VERIFY DOOR PANEL SHAPE IN THIS CATALOG. IF YOUR YEAR/MODEL HAS A DIFFERENT SHAPE/STYLE REAR PANEL THAN OFFERED, PLEASE CALL FOR ASSISTANCE.

## 1972 DUSTER, DUSTER 340, DEMON & DEMON 340 BUCKET & BENCH STYLE

This Legendary product features as-original Die-electrically heat sealed Coachman grain vinyl with woodgrain and chrome accents. Special cutout area in filler board to accommodate armrest base. Padded Multi-Level Construction 3-Dimensional Panel.

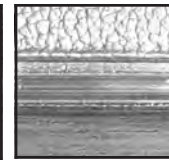
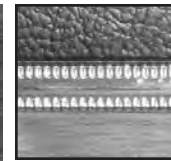
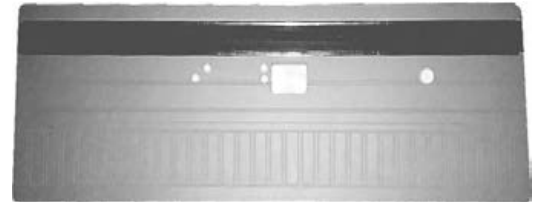
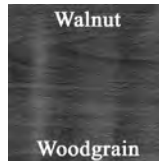

**(C) COLOR CODES:**

- (100) Black
- (200) White
- (340) Bright Blue
- (444) Dark Green
- (666) Ember Gold

Front Panels (Smooth Chrome)..... **DO72CLD0012(C)**  
 Front Panels (Knurled Chrome)..... **DO72CLDK012(C)**  
 (All colors)..... \$482/pr.  
 ☞ Require (12) door clips per panel.

Hardtop Rear Panels (Smooth Chrome)..... **DO72CLD0048(C)F2**  
 Hardtop Rear Panels (Knurled Chrome)..... **DO72CLDK048(C)F2**  
 (All colors)..... \$276/pr.  
 ☞ Please verify door panel shape "F2" is correct for your year model.  
 ☞ Require (7) door clips per panel.

\*IF ORDERING REAR PANELS, PLEASE VERIFY DOOR PANEL SHAPE IN THIS CATALOG. IF YOUR YEAR/MODEL HAS A DIFFERENT SHAPE/STYLE REAR PANEL THAN OFFERED, PLEASE CALL FOR ASSISTANCE.

## 1973 DUSTER & DUSTER 340 BUCKET & BENCH STYLE

This Legendary product features as-original Die-electrically heat sealed Coachman grain vinyl. Special cutout area in filler board to accommodate armrest base. Padded Multi-Level Construction 3-Dimensional Panel.



**(C) COLOR CODES:**

- (100) Black
- (200) White
- (250) Parchment
- (340) Bright Blue
- (444) Dark Green
- (672) Honey Gold

Front Panels ..... **DO73CLVE012(C)**  
 100, 200, 250, 340, 444..... \$502/pr.  
 672..... \$911/pr. (L1)  
 ☞ Customer must re-use original factory aluminum emblem.  
 ☞ Require (12) door clips per panel.

Hardtop Rear Panels ..... **DO73CLV0070(C)F3**  
 100, 200, 250, 340, 444..... \$265/pr.  
 672..... \$559/pr. (L1)  
 ☞ Please verify door panel shape "F4" is correct for your year model.  
 ☞ Require (8) door clips per panel.

\*IF ORDERING REAR PANELS, PLEASE VERIFY DOOR PANEL SHAPE IN THIS CATALOG. IF YOUR YEAR/MODEL HAS A DIFFERENT SHAPE/STYLE REAR PANEL THAN OFFERED, PLEASE CALL FOR ASSISTANCE.



### 1973 DART SPORT & DART SPORT 340 BUCKET & BENCH STYLE

This Legendary product features as-original Die-electrically heat sealed Coachman grain vinyl with woodgrain and chrome accents. Special cutout area in filler board to accommodate armrest base. Padded Multi-Level Construction 3-Dimensional Panel.

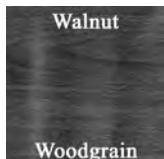
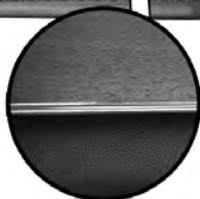

**(C) COLOR CODES:**

- (100) Black
- (200) White
- (250) Parchment
- (340) Bright Blue
- (444) Dark Green
- (672) Honey Gold

Front Panels .....	<b>DO73CLVW012(C)</b>
100, 200, 250, 340, 444.....	\$502/pr.
672.....	\$855/pr. <b>(L1)</b>

⚠ Require (12) door clips per panel.

Hardtop Rear Panels .....	<b>DO73CLVW070(C)F3</b>
100, 200, 250, 340, 444.....	\$287/pr.
672.....	\$532/pr. <b>(L1)</b>

⚠ Please verify door panel shape "F3" is correct for your year model.

⚠ Require (8) door clips per panel.

\*IF ORDERING REAR PANELS, PLEASE VERIFY DOOR PANEL SHAPE IN THIS CATALOG. IF YOUR YEAR/MODEL HAS A DIFFERENT SHAPE/STYLE REAR PANEL THAN OFFERED, PLEASE CALL FOR ASSISTANCE.

### 1974 DUSTER, DUSTER 360 & DART SPORT BUCKET & BENCH STYLE

This Legendary product features as-original Die-electrically heat sealed Oxford grain vinyl. Special cutout area in filler board to accommodate armrest base. Padded Multi-Level Construction 3-Dimensional Panel.

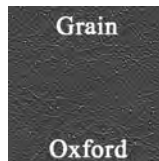

**(C) COLOR CODES:**

- (100) Black
- (200) White
- (264) Parchment
- (360) Lagoon Blue
- (450) Jade Green
- (680) Ember Gold

Front Panels .....	<b>DO74CLVN012(C)</b>
100, 200, 360, 450.....	\$461/pr.
264.....	\$858/pr. <b>(L4)</b>
680.....	\$786/pr. <b>(L1)</b>

⚠ Require (12) door clips per panel.

Hardtop Rear Panels .....	<b>DO74CLV0070(C)F4</b>
100, 200, 360, 450.....	\$265/pr.
264.....	\$539/pr. <b>(L4)</b>
680.....	\$545/pr. <b>(L1)</b>

⚠ Please verify door panel shape "F4" is correct for your year model.

⚠ Require (8) door clips per panel.

\*IF ORDERING REAR PANELS, PLEASE VERIFY DOOR PANEL SHAPE IN THIS CATALOG. IF YOUR YEAR/MODEL HAS A DIFFERENT SHAPE/STYLE REAR PANEL THAN OFFERED, PLEASE CALL FOR ASSISTANCE.

### 1974 DUSTER & DUSTER 360 BUCKET & BENCH STYLE

This Legendary product features as-original Die-electrically heat sealed Oxford grain vinyl. Special cutout area in filler board to accommodate armrest base. Padded Multi-Level Construction 3-Dimensional Panel.



**(C) COLOR CODES:**

- (100) Black
- (200) White
- (264) Parchment
- (360) Lagoon Blue
- (450) Jade Green
- (680) Ember Gold

Front Panels .....	<b>DO74CLVE012(C)</b>
100, 200, 360, 450.....	\$502/pr.
264.....	\$906/pr. <b>(L4)</b>
680.....	\$911/pr. <b>(L1)</b>

⚠ Customer must re-use original factory aluminum emblem.

⚠ Require (12) door clips per panel.

Hardtop Rear Panels .....	<b>DO74CLV0070(C)F4</b>
100, 200, 360, 450.....	\$265/pr.
264.....	\$539/pr. <b>(L4)</b>
680.....	\$545/pr. <b>(L1)</b>

⚠ Please verify door panel shape "F4" is correct for your year model.

⚠ Require (8) door clips per panel.

### 1974 DART SPORT & DART SPORT 360 BUCKET & BENCH STYLE

This Legendary product features as-original Die-electrically heat sealed Oxford grain vinyl with woodgrain and chrome accents. Special cutout area in filler board to accommodate armrest base. Padded Multi-Level Construction 3-Dimensional Panel.

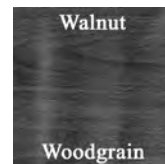
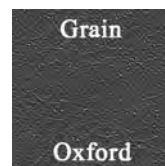

**(C) COLOR CODES:**

- (100) Black
- (200) White
- (264) Parchment
- (360) Lagoon Blue
- (450) Jade Green
- (680) Ember Gold

Front Panels .....	<b>DO74CLVW012(C)</b>
100, 200, 360, 450.....	\$502/pr.
264.....	\$851/pr. <b>(L4)</b>
680.....	\$855/pr. <b>(L1)</b>

⚠ Require (12) door clips per panel.

Hardtop Rear Panels .....	<b>DO74CLVW070(C)F4</b>
100, 200, 360, 450.....	\$287/pr.
264.....	\$516/pr. <b>(L4)</b>
680.....	\$520/pr. <b>(L1)</b>

⚠ Please verify door panel shape "F4" is correct for your year model.

⚠ Require (8) door clips per panel.

\*IF ORDERING REAR PANELS, PLEASE VERIFY DOOR PANEL SHAPE IN THIS CATALOG. IF YOUR YEAR/MODEL HAS A DIFFERENT SHAPE/STYLE REAR PANEL THAN OFFERED, PLEASE CALL FOR ASSISTANCE.

## 1974-75 DART SPORT & DART SPORT 360 "HANG 10" BUCKET & BENCH STYLE

This Legendary product features as-original Die-electrically heat sealed Oxford grain vinyl with multi color inserts. Special cutout area in filler board to accommodate armrest base. Padded Multi-Level Construction 3-Dimensional Panel.

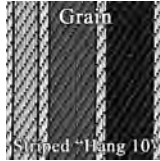

**(C) COLOR CODES:**  
(800) White with Multi-color Insert

Front Panels ..... **DO74CLH0010(C)**  
800..... \$979/pr. (L1)  
☞ Require (12) door clips per panel.

Fold Down Rear Panels (1974)..... **DO74CLH0045(C)F4**  
Fold Down Rear Panels (1975)..... **DO74CLH0045(C)F5**  
\*800 ..... \$646/pr. (L1)  
☞ Please verify door panel shape "F4 or F5" is correct for your year model.  
☞ Require (8) door clips per panel.

\*IF ORDERING REAR PANELS, PLEASE VERIFY DOOR PANEL SHAPE IN THIS CATALOG. IF YOUR YEAR/MODEL HAS A DIFFERENT SHAPE/STYLE REAR PANEL THAN OFFERED, PLEASE CALL FOR ASSISTANCE.

## 1975-76 DUSTER, DUSTER 360 & DART SPORT BUCKET & BENCH STYLE

This Legendary product features as-original Die-electrically heat sealed Oxford grain vinyl. Special cutout area in filler board to accommodate armrest base. Padded Multi-Level Construction 3-Dimensional Panel.

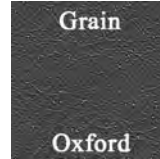

**(C) COLOR CODES:**

- (100) Black
- (200) White
- (264) Parchment
- (360) Lagoon Blue
- (450) Jade Green
- (453) Light Metallic Green
- (680) Ember Gold

Front Panels ..... **DO74CLVN012(C)**  
100, 200, 360, 450 ..... \$461/pr.  
264..... \$858/pr. (L4)  
453, 680..... \$786/pr. (L1)  
☞ Require (12) door clips per panel.

Hardtop Rear Panels ..... **DO75CLV0070(C)F5**  
100, 200, 360, 450 ..... \$265/pr.  
264..... \$539/pr. (L4)  
453, 680..... \$545/pr. (L1)  
☞ Please verify door panel shape "F5" is correct for your year model.  
☞ Require (8) door clips per panel.

\*IF ORDERING REAR PANELS, PLEASE VERIFY DOOR PANEL SHAPE IN THIS CATALOG. IF YOUR YEAR/MODEL HAS A DIFFERENT SHAPE/STYLE REAR PANEL THAN OFFERED, PLEASE CALL FOR ASSISTANCE.

## 1975 DUSTER & DUSTER 360 BUCKET & BENCH STYLE

This Legendary product features as-original Die-electrically heat sealed Oxford grain vinyl. Special cutout area in filler board to accommodate armrest base. Padded Multi-Level Construction 3-Dimensional Panel.



**(C) COLOR CODES:**

- (100) Black
- (200) White
- (264) Parchment
- (360) Lagoon Blue
- (450) Jade Green
- (453) Light Metallic Green
- (680) Ember Gold

Front Panels ..... **DO74CLVE012(C)**  
100, 200, 360, 450..... \$502/pr.  
264..... \$906/pr. (L4)  
453, 680..... \$911/pr. (L1)  
☞ Customer must re-use original factory aluminum emblem.  
☞ Require (12) door clips per panel.

Hardtop Rear Panels ..... **DO75CLV0070(C)F5**  
100, 200, 360, 450..... \$265/pr.  
264 ..... \$539/pr. (L4)  
453, 680 ..... \$545/pr. (L1)  
☞ Please verify door panel shape "F5" is correct for your year model.  
☞ Require (8) door clips per panel.

\*IF ORDERING REAR PANELS, PLEASE VERIFY DOOR PANEL SHAPE IN THIS CATALOG. IF YOUR YEAR/MODEL HAS A DIFFERENT SHAPE/STYLE REAR PANEL THAN OFFERED, PLEASE CALL FOR ASSISTANCE.

## 1975-76 DART SPORT, DART SPORT 360, 1976 DUSTER & DUSTER 360 BUCKET & BENCH STYLE

This Legendary product features as-original Die-electrically heat sealed Oxford grain vinyl with woodgrain and chrome accents. Special cutout area in filler board to accommodate armrest base. Padded Multi-Level Construction 3-Dimensional Panel.

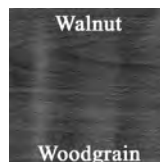

**(C) COLOR CODES:**

- (100) Black
- (200) White
- (264) Parchment
- (360) Lagoon Blue
- (450) Jade Green
- (453) Light Metallic Green
- (680) Ember Gold

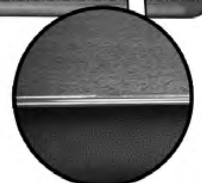

Front Panels ..... **DO74CLVW012(C)**  
100, 200, 360, 450..... \$502/pr.  
264..... \$851/pr. (L4)  
453, 680..... \$855/pr. (L1)  
☞ Require (12) door clips per panel.

Hardtop Rear Panels ..... **DO75CLVW070(C)F5**  
100, 200, 360, 450..... \$287/pr.  
264 ..... \$516/pr. (L4)  
453, 680 ..... \$520/pr. (L1)  
☞ Please verify door panel shape "F5" is correct for your year model.  
☞ Require (8) door clips per panel.

\*IF ORDERING REAR PANELS, PLEASE VERIFY DOOR PANEL SHAPE IN THIS CATALOG. IF YOUR YEAR/MODEL HAS A DIFFERENT SHAPE/STYLE REAR PANEL THAN OFFERED, PLEASE CALL FOR ASSISTANCE.



## 1964-65 BARRACUDA BUCKET STYLE

This Legendary product features as-original Die-electrically heat sealed Bison (64) or Cologne (65) grain vinyl with chrome accents. Special cutout area in filler board to accommodate armrest base. Padded Multi-Level Construction 3-Dimensional Panel.

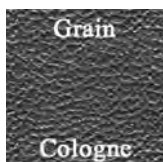
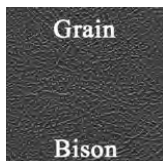

**(C) COLOR CODES:**

- (100) Black ('64-'65)
- (314) Metallic Blue ('64-'65)
- (510) Crimson Red ('64-'65)
- (614) Gold ('64-'65)

**1964 Front Panels** ..... **DO64CBV0010(C)**  
 (All colors)..... \$502/pr.  
 ⚠ Require (12) door clips per panel.

**Fastback Rear Panels** ..... **DO64CB00070(C)**  
 (All colors)..... \$287/pr.  
 ⚠ Require (4) door clips per panel.

**1965 Front Panels** ..... **DO65CBV0010(C)**  
 (All colors)..... \$502/pr.  
 ⚠ Require (12) door clips per panel.

**Fastback Rear Panels** ..... **DO65CB00070(C)**  
 (All colors)..... \$287/pr.  
 ⚠ Require (4) door clips per panel.

## 1966 BARRACUDA BUCKET STYLE

This Legendary product features as-original Die-electrically heat sealed Cologne grain vinyl. Special cutout area in filler board to accommodate armrest base. Padded Multi-Level Construction 3-Dimensional Panel.

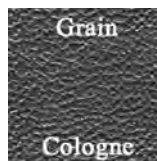

**(C) COLOR CODES:**

- (100) Black
- (202) Pearl White
- (320) Metallic Navy
- (420) Citron
- (505) Red

**Front Panels** ..... **DO66CBV0010(C)**  
 (All colors)..... \$461/pr.  
 ⚠ Require (12) door clips per panel.

**Rear PanelsFastback** ..... **DO66CB00070(C)**  
 (All colors)..... \$265/pr.  
 ⚠ Require (4) door clips per panel.

## 1967 BARRACUDA BUCKET STYLE

This Legendary product features as-original Die-electrically heat sealed Cologne grain vinyl. Special cutout area in filler board to accommodate armrest base. Padded Multi-Level Construction 3-Dimensional Panel.

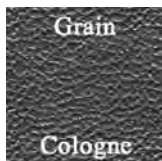
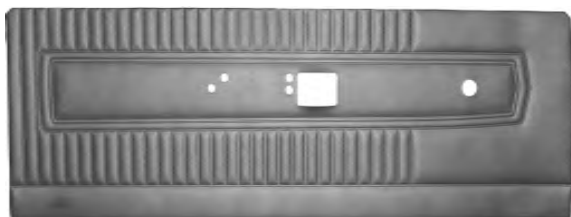

**(C) COLOR CODES:**

- (100) Black
- (202) Pearl White
- (320) Metallic Navy
- (520) Metallic Red
- (618) Light Tan
- (620) Copper

**Front Panels** ..... **DO67CB00012(C)**  
 100, 202, 320, 520, 620..... \$461/pr.  
 618..... \$710/pr. (L1)  
 ⚠ Require (12) door clips per panel.

**Rear Panels Notchback**..... **DO67CB00N48(C)**  
**Rear Panels Fastback** ..... **DO67CB00F48(C)**  
 100, 202, 320, 520, 620..... \$265/pr.  
 618..... \$402/pr. (L1)  
 ⚠ Require (4) door clips per Notchback panel.  
 ⚠ Require (6) door clips per Fastback panel.

## 1968 BARRACUDA STANDARD BUCKET & BENCH STYLE

This Legendary product features as-original Die-electrically heat sealed Cologne grain vinyl. Special cutout area in filler board to accommodate armrest base. Padded Multi-Level Construction 3-Dimensional Panel.

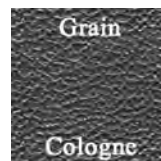
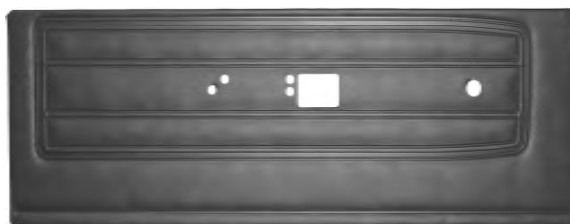

**(C) COLOR CODES:**

- (100) Black
- (202) Pearl White
- (332) Light Metallic Blue
- (430) Dark Metallic Green
- (526) Metallic Maroon

**Front Panels** ..... **DO68CBS0012(C)**  
 (All colors)..... \$461/pr.  
 ⚠ Require (12) door clips per panel.

**Rear Panels Notchback**..... **DO68CBS0N48(C)**  
**Rear Panels Fastback** ..... **DO68CBS0F48(C)**  
 (All colors)..... \$265/pr.  
 ⚠ Require (4) door clips per Notchback panel.  
 ⚠ Require (6) door clips per Fastback panel.



## 1968 BARRACUDA DELUXE BUCKET STYLE

This Legendary product features as-original Die-electrically heat sealed Cologne grain vinyl with woodgrain, chrome accent bands and map pocket. Special cutout area in filler board to accommodate armrest base. Padded Multi-Level Construction 3-Dimensional Panel.

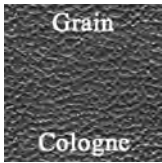

**(C) COLOR CODES:**

- (100) Black
- (202) Pearl White
- (332) Light Metallic Blue
- (430) Dark Metallic Green
- (526) Metallic Maroon
- (636) Ember Gold

Front Panels ..... **DO68CBD0010(C)**  
(All colors)..... \$572/pr.  
☞ Require (12) door clips per panel.

Rear Panels Notchback..... **DO68CBD0N40(C)**  
Rear Panels Fastback ..... **DO68CBD0F40(C)**  
(All colors)..... \$276/pr.  
☞ Require (4) door clips per Notchback panel.  
☞ Require (6) door clips per Fastback panel.

## 1969 BARRACUDA STANDARD BUCKET STYLE

This Legendary product features as-original Die-electrically heat sealed Coachman grain vinyl. Special cutout area in filler board to accommodate armrest base. Padded Multi-Level Construction 3-Dimensional Panel.

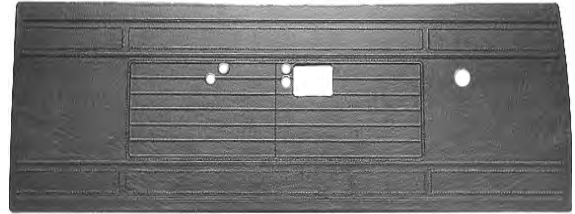

**(C) COLOR CODES:**

- (100) Black
- (200) White
- (338) Bright Blue
- (434) Dark Metallic Green
- (528) Red

Front Panels ..... **DO69CBS0010(C)**  
(All colors)..... \$461/pr.  
☞ Require (12) door clips per panel

Rear Panels Notchback..... **DO69CBS0N48(C)**  
Rear Panels Fastback ..... **DO69CBS0F48(C)**  
(All colors)..... \$265/pr.  
☞ Require (4) door clips per Notchback panel.  
☞ Require (6) door clips per Fastback panel.

## 1969 BARRACUDA DELUXE BUCKET STYLE

This Legendary product features as-original Die-electrically heat sealed Coachman grain vinyl with woodgrain, chrome accent bands and map pocket. Cutout area in filler board to accommodate armrest base. Padded Multi-Level Construction 3-Dimensional Panel.

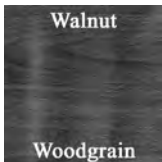

**(C) COLOR CODES:**

- (100) Black
- (130) Pewter
- (338) Bright Blue
- (434) Dark Metallic Green
- (528) Red
- (644) Sun Gold Yellow
- (650) Saddle

Front Panels ..... **DO69CBD0010(C)**  
(All colors)..... \$508/pr.  
☞ Require (12) door clips per panel.

Rear Panels Notchback..... **DO69CBD0N40(C)**  
Rear Panels Fastback ..... **DO69CBD0F40(C)**  
(All colors)..... \$265/pr.  
☞ Require (4) door clips per Notchback panel.  
☞ Require (6) door clips per Fastback panel.

## 1969 "MOD TOP" BARRACUDA BUCKET STYLE

This Legendary product features as-original Die-electrically heat sealed Coachman grain skirts with Mod inserts. Special cutout area in filler board to accommodate armrest base. Padded Multi-Level Construction 3-Dimensional Panel.



**(C) COLOR CODES:**

- (645) Yellow Mod (642) / Sun Gold Yellow (644)
- (677) Yellow Mod (642) / Dark Metallic Green (434)

Front Panels ..... **DO69CBD0010(C)**  
645, 677..... \$697/pr. (L1)  
☞ Require (12) door clips per panel.

Rear Panels Notchback..... **DO69CBD0N40(C)**  
645, 677..... \$402/pr. (L1)  
☞ Require (4) door clips per Notchback panel.  
☞ Require (6) door clips per Fastback panel.



**1970-74 BARRACUDA,  
'CUDA & GRAN COUPE  
BUCKET & BENCH STYLE**



**(C) COLOR CODES:**

- (100) Black (70-74)
- (200) White (70-74)
- (338) Bright Blue (70)
- (550) Red (70)

"OEM" Front Panels (Injection Molded As-Original)

.....	<b>DO70CB0MM12(C)N</b> 
(100, 200) .....	\$799/pr.
(338, 550) .....	\$666/pr.

*For manuals cars. Panels have side markings on the backside indicating where to cut for power window option. This must be done by customer.*

"OEM" Rear Panels (Injection Molded As-Original)

Htp .....	<b>DO70CB0MM48(C)</b> 
Conv. ....	<b>Currently N/A</b>
(100, 200) .....	\$699/pr.
(338, 550) .....	\$666/pr.

**1970-74 CHALLENGER,  
CHALLENGER R/T & T/A  
BUCKET & BENCH STYLE**



**(C) COLOR CODES:**

- (100) Black (70-74)
- (200) White (70-74)
- (338) Bright Blue (70)
- (550) Red (70)

"OEM" Front Panels (Injection Molded As-Original)

.....	<b>DO70CJ0MM12(C)N</b> 
(100, 200) .....	\$679/pr.
(338, 550) .....	\$666/pr.

*For manuals cars. Panels have side markings on the backside indicating where to cut for power window option. This must be done by customer.*



"OEM" Rear Panels (Injection Molded As-Original)

Htp .....	<b>DO70CJ0MM48(C)</b> 
Conv. ....	<b>Currently N/A</b>
(100, 200) .....	\$639/pr.
(338, 550) .....	\$666/pr.



## 1964-65 SUPERSTOCK

This Legendary product features as-original Die-electrically heat sealed Bison grain vinyl.  
Special cutout area in filler board to accommodate armrest base. Padded Multi-Level  
Construction 3-Dimensional Panel.

Front Door Panels (Unassembled) ..... **DO64CSS0010(C)**  
.....\$722/pr.  
Front Door Panels (Pre-Assembled) ..... **DO64CSS0010(C)-PA**   
.....\$1080/pr.

 Window felt strip included.  
 Customer must provide original upper rail.

Rear Door Panels (Unassembled) ..... **DO64CSS0040(C)**  
.....\$303/pr.  
Rear Door Panels (Pre-Assembled) ..... **DO64CSS0040(C)-PA**   
.....\$569/pr.

 Window felt strip included.  
 Customer must provide original upper rail.

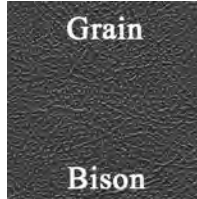

**(C) COLOR CODES:**

- (100) Black
- (510) Crimson Red
- (610) Metallic Fawn



1965 Super Stock



## ARMREST PADS A-BODY MODELS



1967 A-Body reproduction 7 1/2" front armrest pads.

**AP67CBLV01F2** (Black)..... \$99.00/pr.  
**AP67CBLV02F2** (White) . currently not available



1968-72 A-Body reproduction 7 1/2" front and rear armrest pads.

**AP68CBLV-FRT100** (Black)..... \$109.00/pr.  
**AP68CBLV-FRT200** (White) ..... \$109.00/pr.  
**AP68CBLV-FRT202** (Pearl White)..... \$109.00/pr.  
**AP68CBLV-FRT330** (Dark Met. Blue).... \$109.00/pr.  
**AP68CBLV-FRT332** (Light Met. Blue) ... \$109.00/pr.  
**AP68CBLV-FRT338** (Bright Blue)..... \$109.00/pr.  
**AP68CBLV-FRT340** (Bright Blue)..... \$109.00/pr.  
**AP68CBLV-FRT430** (Dark Met. Green) . \$109.00/pr.  
**AP68CBLV-FRT432** (Light Met. Green) . \$109.00/pr.  
**AP68CBLV-FRT434** (Dark Met. Green) . \$109.00/pr.  
**AP68CBLV-FRT444** (Dark Green)..... \$109.00/pr.  
**AP68CBLV-FRT452** (Dark Met. Green) . \$109.00/pr.  
**AP68CBLV-FRT507** (Red)..... \$109.00/pr.  
**AP68CBLV-FRT520** (Metallic Red)..... \$109.00/pr.  
**AP68CBLV-FRT526** (Metallic Maroon) .. \$109.00/pr.  
**AP68CBLV-FRT528** (Red)..... \$109.00/pr.  
**AP68CBLV-FRT550** (Red)..... \$109.00/pr.  
**AP68CBLV-FRT560** (Bright Orange).... \$109.00/pr.  
**AP68CBLV-FRT630** (Gold)..... \$109.00/pr.  
**AP68CBLV-FRT632** (Dark Met. Fawn) .. \$109.00/pr.  
**AP68CBLV-FRT634** (Light Met. Fawn) .. \$109.00/pr.  
**AP68CBLV-FRT636** (Ember Gold) ..... \$109.00/pr.  
**AP68CBLV-FRT644** (Sungold Yellow) ... \$109.00/pr.  
**AP68CBLV-FRT650** (Saddle)..... \$109.00/pr.  
**AP68CBLV-FRT656** (Brown)..... \$109.00/pr.  
**AP68CBLV-FRT664** (Brown)..... \$109.00/pr.  
**AP68CBLV-FRT666** (Ember Gold) ..... \$109.00/pr.

☞ Some early production 1968 A-Body models used 1967 armrest pads. If your model uses a 1967 style please use armrest pad #AP67CBLV01F2 (Black) or AP67CBLV02F2 (White) at time of order.

## ARMREST PADS CONT. E-BODY MODELS



1970-74 Barracuda reproduction front armrest pads.

**AP70CB100F2** (Black)..... \$119.00/pr.  
**AP70CB200F2** (White)..... \$119.00/pr.  
**AP70CB338F2** (Bright Blue '70) ..... \$119.00/pr.  
**AP70CB340F2** (Bright Blue '71-'73) . \$119.00/pr.  
**AP70CB550F2** (Red) ..... \$119.00/pr.

☞ All colored armrest pads are matched to the standard or deluxe door panels



1970-74 Challenger reproduction front armrest pads.

**AP70CJ100F2** (Black)..... \$119.00/pr.  
**AP70CJ200F2** (White) ..... \$119.00/pr.

☞ All colored armrest pads are matched to the standard or deluxe door panels

## ARMREST BASES A-BODY MODELS



1964-66 A-Body reproduction 10" armrest bases. These bases feature correct smooth chrome finish.

**AP64A-BASE**..... \$99.00/pr.



1964-65 A-Body reproduction 15" armrest bases. Bases feature correct smooth chrome finish.

**AP64ABC-BASE**..... \$99.00/pr.



1968-72 A-Body reproduction front armrest bases. These bases feature correct smooth chrome finish.

**AP68A-BASEFRT**..... \$89.00/pr.

## ARMREST BASES CONT. A-BODY MODELS



1968-72 A-Body reproduction rear armrest bases. These bases feature correct smooth chrome finish.

**AP68A-BASERR**..... \$89.00/pr.



1968-72 A-Body reproduction rear armrest bases. These bases feature the correct smooth black finish.

**AP68A-BASERR01**..... \$89.00/pr.

## DOOR PANEL CLIPS



Door panel clips for all models except E-Body models.

**DOCLIP**..... \$1.00/ea.

## DOOR LOCK KNOBS



Door lock knobs for all 1964-74 A-Body models. Available in black or chrome.

**BT64ABC/DOOR-B** (Black)..... \$15.00/pr.

**BT64ABC/DOOR-C** (Chrome)..... \$9.00/pr.

☞ Will not work for E-Body models.

## DOOR LOCK FERRULES

Authentically reproduced ferrules support the door lock knob.

**1964-74 A-Body (all models)**

**BT64CBLV-FERRULE**..... \$19.00/pr.

☞ Injection molded clear plastic.



ASH TRAYS

Reproduction ash trays and bezels for 1970 E-Body rear interior panels and 1971-74 E-Body consoles.

**1970 E-Body (rear interior panels only)**  
**AT66BE**.....\$63.00/ea.

**1971-74 E-Body (console only)**  
**AT66BE**.....\$63.00/ea.

DOOR PANEL EMBLEMS



1970-74 'Cuda model door panel emblem.  
**DO70CB-EMBLEM** ..... discontinued  
 ☞ Use (2) per car



1970-71 Barracuda Gran Coupe models.  
**DO70CBD-EMBLEM**..... discontinued  
 ☞ Use (2) per car.

DOOR PANEL WOODGRAIN



1970-74 Challenger door panel woodgrain.  
**DO70CJ-WOODGRAIN** .....\$19.00/pr.  
 ☞ Customer must reuse original center emblems.



DOOR PANEL CARPET TRIM

1970-73 Challenger door panel carpet trim. This carpet trim piece features a new board with vinyl edge binding color-matched to your interior.  
**DO70CJ(XX)**  
 (All colors)..... \$148.00/pr.  
 ☞ Please refer to carpet color selection page to specify carpet color at time of order.  
 ☞ For correct vinyl color please refer to the year's color codes listed in this catalog.

DOOR HANDLES  
 A-BODY DOOR HANDLES



1963-66 A-Body door handles.  
**CK63ABC-DOOR**..... \$39.00/pr.



1968-72 A-Body inside door handles.  
**CK66AB-DOOR** ..... \$59.00/pr.

E-BODY MODELS



1970-74 Cuda inside door handles.  
**CK70CB-DOOR** ..... \$59.00/pr.



1970-74 Challenger inside door handles.  
**CK70CJ-DOOR**..... \$49.00/pr.

WINDOW CRANK SPACERS



Front and rear window crank spacers for all 1968-74 A & E-Body models

**1968-74 A & E-Body (all models)**  
**CK68SPACER**..... \$5.00/ea.  
 ☞ Will work for front and rear windows on A-Body models.  
 ☞ Will only work for front windows on E-Body models.

**1970-74 E-Body (Challenger)**  
**CK70SPACER2 (Rear windows)**..... \$5.00/ea.  
 ☞ 1/4" thick washer.

**1970-74 E-Body (Barracuda)**  
**CK70SPACER3 (Rear windows)**..... \$10.00/ea.  
 ☞ 1/2" thick textured washer.

WINDOW CRANKS



1963-66 A-Body window cranks  
**CK63ABC-WNDW** ..... \$29.00/ea.



1963-66 A-Body quarter glass window cranks  
**CK63ABC-QTR**..... \$29.00/ea.



Reproduction front and rear window cranks for all 1967-74 A & E-Body models. Chrome plated with black knob.

**1967 A-Body (all models)**  
**CK67ABC-WNDW** .....\$29.00/ea.  
 ☞ Correct for front and rear windows.

**1968-74 A-Body (all models)**  
**1970-74 (Barracuda & Challenger)**  
**CK68C-WNDW**.....\$59.00/pr.  
 ☞ Correct for front and rear windows.  
 ☞ Screws and washers not included.

**1968-74 A-Body (all models)**  
**CK68C-WNDW1**.....\$69.00/pr.  
 ☞ Correct for front and rear windows.  
 ☞ Screws and thin washers included in this kit.  
 ☞ Will not work for rear windows in 1970-74 E-Body models.

**1970-74 Challenger**  
**CK70C-WNDW2 (Rear windows)**.....\$69.00/pr.  
 ☞ Screws and 1/4" thick washers included in this kit.

**1970-74 Barracuda**  
**CK70C-WNDW3 (Rear windows)**.....\$69.00/pr.  
 ☞ Screws and 1/2" thick textured washers included in kit.

WINDOW CRANK SCREWS



Chrome plated window crank screws with hex like head for all 1968-74 A & E-Body models.

**CK68SCREW** ..... \$2.00/ea.  
 ☞ Use (4) per car.

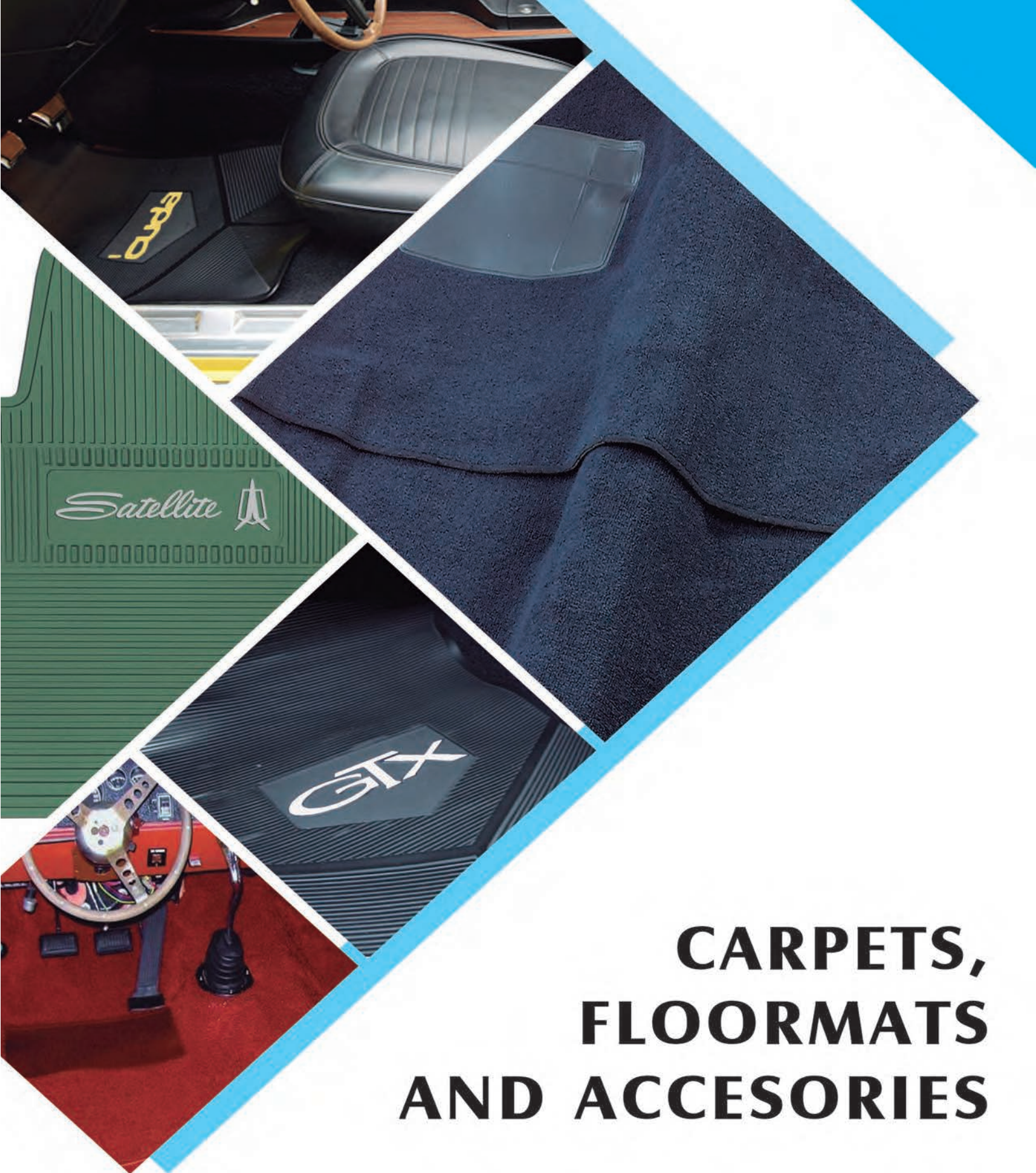

VENT WINDOW CRANKS

**1967 A & E-Body (all models)**  
**CK67ABC-VENT** ..... \$29.00/ea.



# CARPETS, FLOORMATS AND ACCESORIES

 [facebook.com/legendaryautointeriors](https://facebook.com/legendaryautointeriors)  
 [twitter.com/legendaryautoin](https://twitter.com/legendaryautoin)

 [www.legendaryautointeriors.com](http://www.legendaryautointeriors.com)  
 [instagram.com/legendaryautointeriorsltd](https://instagram.com/legendaryautointeriorsltd)  
 [youtube.com/user/legendaryauto](https://youtube.com/user/legendaryauto)



# MODEL SPECIFIC CARPET

Legendary brand molded carpets utilize the heaviest face weight cutpile and loop carpet combined with an extra heavy poly coated backing that provides for an accurate and sharply detailed mold formed area. Surged edges and accurately die cut and applied 40oz. felt underlayment is the finishing touch to our vehicle specific carpets.

## **Bound and Surged Edges**

Both Legendary cutpile and loop molded carpets have a heavy duty bound and surged edge that provides for an easy installation and clean appearance.



## **Underlayment Padding**

Legendary molded carpets are made with a 40 oz. felt underlayment padding. All padding is trimmed around seat track mounts, seat belt holes and covers the most area than any carpet in the industry!



# 80/20 LOOP CARPET COLOR SELECTOR (c)

<b>01</b> BLACK	<b>03</b> RED	<b>04</b> AQUA	<b>05</b> DARK TEAL	<b>06</b> FORD BLUE	<b>07</b> DARK BLUE	<b>08</b> TEAL	<b>09</b> SHADE 13 BLUE
<b>10</b> BRIGHT BLUE	<b>11</b> MEDIUM BLUE	<b>12</b> GREEN	<b>13</b> DARK GREEN	<b>14</b> DARK OLIVE GREEN	<b>15</b> BLUE GREEN	<b>16</b> MOSS GREEN	<b>21</b> MEDIUM RED
<b>22</b> BURNT ORANGE	<b>24</b> ROSE BEIGE	<b>25</b> DARK BROWN	<b>26</b> SADDLE	<b>27</b> LT/MEDIUM SADDLE	<b>28</b> DARK COPPER	<b>29</b> DARK SADDLE	<b>31</b> MAROON
<b>32</b> GOLD	<b>33</b> DARK GOLD	<b>34</b> FAWN	<b>35</b> RED TUXEDO	<b>36</b> BLUE TUXEDO	<b>37</b> AQUA TUXEDO	<b>38</b> LIGHT GREEN	<b>39</b> ORANGE
<b>40</b> PLUM	<b>41</b> SUNSET GLOW	<b>42</b> SILVER MINK	<b>44</b> CORAL	<b>45</b> EMBER GLOW	<b>46</b> IVY GOLD	<b>47</b> FAWN TUXEDO	<b>48</b> SILVER
<b>49</b> GUNMETAL GRAY	<b>50</b> PARCHMENT	<b>51</b> MIDNIGHT BLUE	<b>53</b> GOLD TUXEDO	<b>54</b> COPPER TUXEDO	<b>55</b> OLIVE TUXEDO	<b>81</b> CHARCOAL	

**\*\*36oz. JUTE PADDING INCLUDED WHERE PADDING WAS ORIGINAL.**

**\*\*VINYL BOUND EDGE WHERE THE FRONT AND REAR SECTIONS OF THE CARPET OVERLAP.**

**\*\*COLOR MATCHED ORIGINAL HEEL PAD ACCURATELY APPLIED USING THE SAME METHOD AS OEM.**

**\*\*MEETS OR EXCEEDS OEM SPECIFICATIONS.**

**\*\*DIMMER SWITCH GROMMET INCLUDED.**

**\*\*COLOR SAMPLES ARE AVAILABLE FOR COLORS OTHER THAN BLACK.**

**\*\*DYE LOTS WILL VARY +/- 10%. THIS IS COMMON IN THE CARPET INDUSTRY. CUSTOMERS ARE ENCOURAGED TO ORDER ALL CARPETED PRODUCTS AT THE SAME TIME TO ENSURE MATCHING DYE LOT.**

**\*\*FOR YEARS AND MODELS NOT LISTED PLEASE CALL OUR SALES DEPARTMENT AT 800-363-8804**



# CUTPILE

# CARPET COLOR SELECTOR (c)

<b>801</b> <b>BLACK</b>	<b>802</b> <b>BLUE</b>	<b>807</b> <b>DK. GRAY</b>	<b>808</b> <b>TURQUOISE</b>	<b>810</b> <b>BROWN</b>	<b>812</b> <b>ROYAL BLUE</b>	<b>815</b> <b>RED</b>	<b>818</b> <b>OCEAN BLUE</b>
<b>819</b> <b>DK. BLUE</b>	<b>820</b> <b>SADDLE</b>	<b>821</b> <b>TAUPE</b>	<b>825</b> <b>MAROON</b>	<b>830</b> <b>BUCKSKIN</b>	<b>835</b> <b>FIRETHORNE</b>	<b>839</b> <b>FED. BLUE</b>	<b>840</b> <b>NAVY</b>
<b>849</b> <b>JADE GREEN</b>	<b>850</b> <b>CHAMOIS</b>	<b>852</b> <b>SILVER</b>	<b>854</b> <b>CARAMEL</b>	<b>857</b> <b>MED. GRAY</b>	<b>869</b> <b>WILLOW GREEN</b>	<b>871</b> <b>SANDALWOOD</b>	<b>875</b> <b>OXBLOOD</b>
<b>877</b> <b>DOVE GRAY</b>	<b>885</b> <b>LT. MAROON</b>	<b>897</b> <b>CHARCOAL</b>	<b>1251</b> <b>ALMOND</b>	<b>1804</b> <b>SILVER</b>	<b>4033</b> <b>MIDNIGHT BLUE</b>	<b>4305</b> <b>OXBLOOD</b>	<b>4640</b> <b>SADDLE</b>
<b>4643</b> <b>POWDER BLUE</b>	<b>4666</b> <b>SMOKE</b>	<b>4880</b> <b>SAGE GREEN</b>	<b>7037</b> <b>CAMEL TAN</b>	<b>7039</b> <b>CARMINE</b>	<b>7075</b> <b>OYSTER</b>	<b>7099</b> <b>ANTELOPE</b>	<b>7130</b> <b>DK. BLUE</b>
<b>7140</b> <b>MED. SADDLE</b>	<b>7295</b> <b>MEDIUM DOESKIN</b>	<b>7298</b> <b>MAPLE</b>	<b>7500</b> <b>BRIAR BROWN</b>	<b>7623</b> <b>MEDIUM SAND GRAY</b>	<b>7701</b> <b>GRAPHITE</b>	<b>7766</b> <b>BLUE</b>	<b>8046</b> <b>SILVER</b>
<b>8075</b> <b>MED. GRAY</b>	<b>8082</b> <b>LT. CRYSTAL BLUE</b>	<b>8384</b> <b>DESERT TAN</b>	<b>8801</b> <b>FLAME RED</b>	<b>8991</b> <b>FORD SANDALWOOD</b>	<b>9006</b> <b>LIGHT MOCHA</b>	<b>9196</b> <b>MED. OPAL</b>	<b>9197</b> <b>MEDIUM MOCHA</b>
<b>9199</b> <b>SMOKE</b>	<b>9229</b> <b>STEEL BLUE</b>	<b>9304</b> <b>REGATTA BLUE</b>	<b>9577</b> <b>MEDIUM DARK OAK</b>	<b>9777</b> <b>BEIGE</b>	<b>9779</b> <b>MED. GRAY</b>	<b>9779</b> <b>TORCH RED</b>	<b>2000</b> <b>CHROME YELLOW</b>
<b>2947-A</b> <b>RED</b>	<b>2005</b> <b>HUGGER ORANGE</b>	<b>1998</b> <b>ROYAL PURPLE</b>	<b>2003</b> <b>LIMELIGHT GREEN</b>	<b>2004</b> <b>ELECTRIC BLUE</b>	<b>8500</b> <b>WHITE</b>	<b>1999</b> <b>POWER PUMPKIN</b>	<b>2001</b> <b>FUCHSIA</b>

\*For colors other than BLACK, a clean, non-faded sample may be helpful to assure a correct color match when ordering. Samples are available upon request. Dye lots will vary +/- 10%. This is common to industry standards and must be understood by the customer on all colors with or without sample approval. Customers are encouraged to order all carpeted products at one time to ensure the best dye lot matching. Carpeted items include: Seat back panels, Console carpet kits and certain model door panel carpet trim.

**CARPET (NYLON LOOP)**

The finest available today. Two-piece pre-molded shape made with an original specification blend of 100% Nylon. All carpets include 36oz. jute padding on the backside, dimmer switch grommet, color matched original style heel pad and vinyl bound edge where the front and rear sections overlap. Carpet kits are not shipped with pre-cut holes and must be done during installation of carpet. Some other minor trimming may be needed.

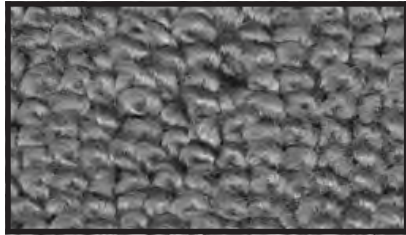

Loop Style

A-BODY MODELS

**1963-66 A-Body**

- CA63AA(C) (2-door/Automatic) ..... \$195.00/ea.
- CA63AS(C) (2-door/Manual)..... \$195.00/ea.

**1963-65 A-Body "Tuxedo" style**

- CA63AA(C) (2-door/Automatic) ..... \$309.00/ea.
- CA63AS(C) (2-door/Manual)..... \$309.00/ea.

**1964-66 Barracuda (Fastback)**

- (Full Set Front & Rear)
- CA64AA(C)F (Automatic)..... \$569.00/ea.
- CA64AS(C)F (Manual)..... \$569.00/ea.

**1967-69 Barracuda (Fastback)**

- (Full Set Front & Rear)
- CA67AA(C)F (Automatic)..... \$459.00/ea.
- CA67AS(C)F (Manual)..... \$459.00/ea.
- \*Price depends on color

**1967-76 A-Body & 1966-69 Barracuda**

- (Floorpan Only)
- CA67AA(C) (2-door/Automatic) ..... \$195.00/ea.
- CA67AS(C) (2-door/Manual)..... \$195.00/ea.
- Will not work for 1967-69 Barracuda fastback models.

C-BODY MODELS

**1963-71 C-Body**

- CA63CA(C) (2-door/Automatic) ..... \$275.00/ea.
- CA63CS(C) (2-door/Manual)..... \$275.00/ea.
- CA63C4DA(C) (4-door/Automatic)..... \$275.00/ea.

E-BODY MODELS

**1970 Barracuda**

- CA70CBA(C) (Automatic) ..... \$195.00/ea.
- CA70CBS(C) (Manual)..... \$195.00/ea.

**1971-74 Barracuda**

- CA71CBA(C) (Automatic) ..... \$195.00/ea.
- CA71CBS(C) (Manual)..... \$195.00/ea.

**1970 Challenger**

- CA70CJA(C) (Automatic)..... \$195.00/ea.
- CA70CJS(C) (Manual) ..... \$195.00/ea.

**1971-74 Challenger**

- CA71CJA(C) (Automatic)..... \$195.00/ea.
- CA71CJS(C) (Manual) ..... \$195.00/ea.

**1964-1966 Barracuda Fastback Carpet Diagram**



- 1 - Molded Front
- 2 - Molded Rear
- 3 - Seatback (Fold-down)
- 4 - Rear Cargo Panel
- 5/6 - Molded Rear Wheel Wells
- 7 - Trunk Divider (Fold-down)
- 8 - Trunk Mat

80/20 LOOP CARPET COLORS (C)

- |                       |                    |
|-----------------------|--------------------|
| (01) Black            | (32) Gold          |
| (03) Red              | (33) Dark Gold     |
| (04) Aqua             | (34) Fawn          |
| (05) Teal             | (36) Blue Tuxedo   |
| (06) Ford Blue        | (37) Aqua Tuxedo   |
| (07) Dark Blue        | (38) Light Green   |
| (08) Teal             | (39) Orange        |
| (09) Shade 13 Blue    | (40) Plum          |
| (10) Bright Blue      | (41) Sunset Glow   |
| (11) Medium Blue      | (42) Silver Mink   |
| (12) Green            | (44) Coral         |
| (13) Dark Green       | (45) Ember Glow    |
| (14) Dark Olive Green | (46) Ivy Gold      |
| (15) Blue Green       | (47) Fawn Tuxedo   |
| (16) Moss Green       | (48) Silver        |
| (21) Medium Red       | (49) Gunmetal Grey |
| (22) Burnt Orange     | (50) Parchment     |
| (24) Rose Beige       | (51) Midnight Blue |
| (25) Dark Brown       | (53) Gold Tuxedo   |
| (26) Saddle           | (54) Copper Tuxedo |
| (27) Lt/Med Saddle    | (55) Olive Tuxedo  |
| (28) Dark Copper      | (81) Charcoal      |
| (29) Dark Saddle      |                    |
| (31) Maroon           |                    |

\*For colors other than BLACK, a clean, non-faded sample may be helpful to assure a correct color match when ordering. Samples are available upon request. Dye lots **will** vary +/- 10%. This is common to industry standards and must be understood by the customer on all colors with or without sample approval. Customers are encouraged to order all carpeted products at one time to ensure the best dye lot matching.

## CUT-PILE CARPET

Correct cut pile nylon carpet for 1972 and later cars and trucks. All carpets include 36oz. jute padding on the backside, dimmer switch grommet, color matched original style heel pad and vinyl bound edge where the front and rear sections overlap. Carpet kits not shipped with pre-cut holes and must be done during installation of carpet. Colors other than black require sample approval. Please call for samples.

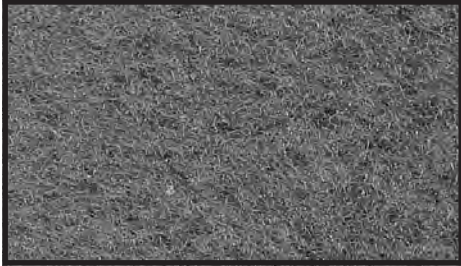

Cut-Pile Style

### A-BODY MODELS

#### **1972-76 A-Body**

**CA67AA(C)P** (2-door/Automatic)..... \$195.00/ea.

**CA67AS(C)P** (2-door/Manual) ..... \$195.00/ea.

### F-BODY MODELS

#### **1976-80 F-Body**

**CA76CFA(C)P** (Automatic) ..... \$195.00/ea.

**CA76CFS(C)P** (Manual)..... \$195.00/ea.

### DODGE TRUCK

#### **1977-91**

**CA77D150A(C)P** (Automatic) ..... \$195.00/ea.

☞ Available for 2 wheel drive models only.

## CARPET YARDAGE

### **Loop Carpet**

**CAYD(C)** (1 yard) .....\$79.00/yd.

☞ For colors other than black please refer to color code list

### **Loop "Tuxedo" Carpet**

**CAYD(C)** (1 yard) ..... \$129.00/yd.

☞ For colors other than black please refer to color code list

### **Cut-pile Carpet**

**CAYD(C)P** (1 yard).....\$79.00/yd.

## JUTE BACKING

This insulating material when placed between the floorpan and molded carpet enhances sound barrier protection from road noise and adds cushion to your carpet. Also helpful for insulating headliners, trunk areas and more. 36"x36" cut.

**TA20OZFELT** (20 oz.) ..... \$19.00/yd.

**TA40OZFELT** (40 oz.) ..... \$29.00/yd.





# LEGENDARY'S CUSTOM VINTAGE RUBBER STYLE FLOORMATS

## DESIGNED TO FIT WHOLE FLOORPAN OF CAR LOGOS ON FRONT AND REAR MATS

How many times have you wished for automotive floor mats that have custom-fit floopan shapes, that are easily cleanable and also have that "factory original" styling that would make you proud to display them in your classic car? Our "Custom Vintage" rubber style floor mats will please the most discriminating buyer and provide years of carefree use.



[www.legendaryautointeriors.com](http://www.legendaryautointeriors.com)

# CUSTOM DESIGN FLOORMATS

AVAILABLE IN ALL YEARS,  
MAKES AND MODELS



**1 Color  
insert**

Adds \$25 to base price



**2 Color  
insert**

Adds \$50 to base price

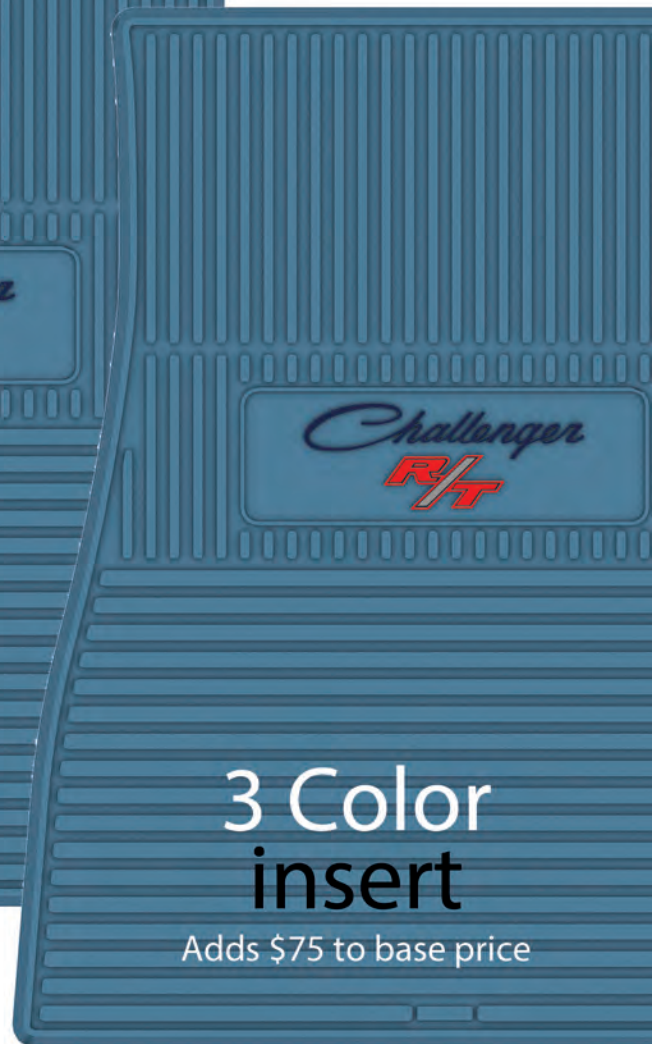

**3 Color  
insert**

Adds \$75 to base price

**DESIGN YOUR OWN  
INSERTS & COLORS**

[www.legendaryautointeriors.com](http://www.legendaryautointeriors.com)



# FLOORMAT BASE & INSERT COLORS

## BASE COLORS

001 Black - 007 Dark Blue - 011 Medium Blue - 018 Bright Red - 020 Red - 023 Tan - 031 Maroon  
 033 Dark Gold - 037 Aqua - 050 Turquoise - 057 Dk Olive Green - 079 Gray  
 098 Brown - 129 Dark Saddle - 132 Gold - 148 Silver Grey

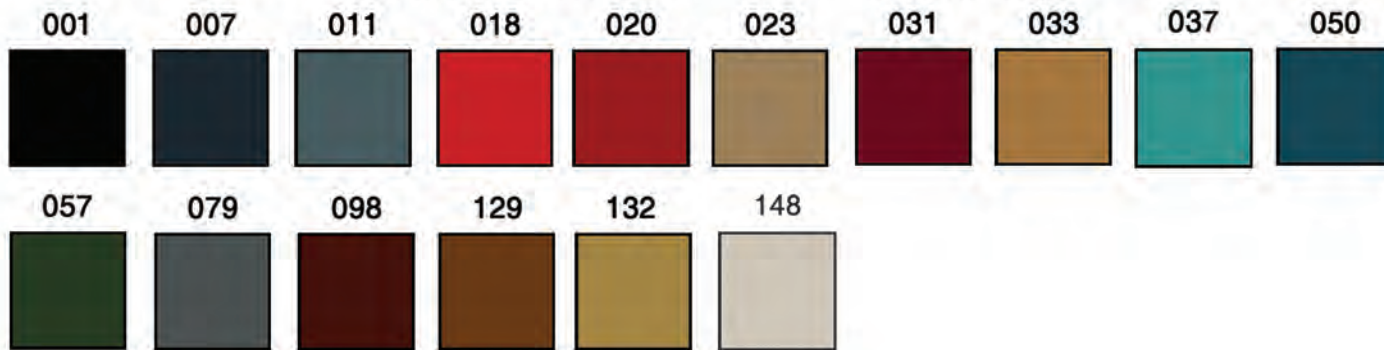

## INSERT COLORS

133 Cream - 134 Sandalwood - 137 Aztec Gold - 138 Buckskin - 139 Sienna - 141 Coffee Bean - 142 Football - 143 Basketball  
 150 Lemon Twist - 151 Mellow Yellow - 153 Precious Purple - 154 Plum Crazy - 155 Moody Blue - 156 Sky Blue  
 157 Light Blue - 159 Pacific Blue - 160 Caribbean Blue - 161 Royal Blue - 163 Navy Blue - 164 Groovy Blue  
 165 Sassy Grass - 166 Pine - 167 Mint Green - 168 Hunter Green - 169 Antique Green - 170 Aqua Marine - 171 Mango  
 172 Awesome Orange - 173 Sunset Orange - 174 Panther Pink - 175 Radical Red - 176 Cherry Red - 177 Cranberry  
 178 Razzberry - 179 Garnet - 180 Smoke - 181 Platinum - 182 Medium Grey - 183 Silver - 184 Charcoal



**\*Note - To order mats with colored inserts please call our sales department**

Actual colors will vary from samples on this page. Contact our Sample Request Department for actual color samples at 1-800-363-8804 or send us an email through our Sample Request Center on our website at [www.legendaryautointeriors.com](http://www.legendaryautointeriors.com)

# 1963-66 DODGE & PLYMOUTH A-BODY



www.legendaryautointeriors.com



**ALL NEW  
DESIGN!!**

**FLOORMAT PRICING:**  
**ALL COLORS - \$249.00/set**

**1963 Dart**  
FMCLV021001(C) - Automatic FMCLV021002(C) - 4-speed

**1963 Dart 170**  
FMCLV022001(C) - Automatic FMCLV022002(C) - 4-speed

**1963 Dart 270**  
FMCLV023001(C) - Automatic FMCLV023002(C) - 4-speed

**1963-64 Dart GT**  
FMCLV024001(C) - Automatic FMCLV024002(C) - 4-speed

**1964 Dart 170**  
FMCLV025001(C) - Automatic FMCLV025002(C) - 4-speed

**1964 Dart 270**  
FMCLV026001(C) - Automatic FMCLV026002(C) - 4-speed

**1965 Dart 270**  
FMCLV027001(C) - Automatic FMCLV027002(C) - 4-speed

**1965 Dart**  
FMCLV028001(C) - Automatic FMCLV028002(C) - 4-speed

**1965-66 Dart GT**  
FMCLV029001(C) - Automatic FMCLV029002(C) - 4-speed

**1966 Dart 270**  
FMCLV030001(C) - Automatic FMCLV030002(C) - 4-speed

**1963 Valiant Signet 200**  
FMCLV031001(C) - Automatic FMCLV031002(C) - 4-speed

**1963 Valiant**  
FMCLV032001(C) - Automatic FMCLV032002(C) - 4-speed

**1964 Valiant Signet 200**  
FMCLV033001(C) - Automatic FMCLV033002(C) - 4-speed

**1964 Valiant**  
FMCLV034001(C) - Automatic FMCLV034002(C) - 4-speed

**1965 Valiant 100**  
FMCLV035001(C) - Automatic FMCLV035002(C) - 4-speed

**1965 Valiant 200**  
FMCLV036001(C) - Automatic FMCLV036002(C) - 4-speed

**1966 Valiant Signet**  
FMCLV040001(C) - Automatic FMCLV040002(C) - 4-speed

**1964-66 Barracuda**  
FMCU0001001(C) - Automatic FMCU0001002(C) - 4-speed

1963 Dart



1963 Dart 170



1963 Dart 270



1963-64 Dart GT



1964 Dart 170



1964 Dart 270



1965 Dart 270



1965 Dart



1965-66 Dart GT



1966 Dart 270



1963 Valiant Signet 200

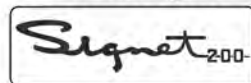

1963 Valiant



1964 Valiant Signet 200

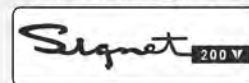

1964 Valiant



1965 Valiant 100



1965 Valiant 200



1966 Valiant Signet



1964-66 Barracuda

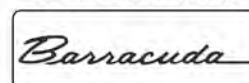

# 1967-76 PLYMOUTH DUSTER & SCAMP

DUSTER



1967-69 Valiant 100 - Block letters w/ Plymouth emblem  
FMCLV016001(C) - Automatic FMCLV016002(C) - 4-speed

1967-69 Valiant Signet - Block letters w/ Signet script  
FMCLV017001(C) - Automatic FMCLV017002(C) - 4-speed

1971-76 Scamp - Block letters  
FMCLV002001(C) - Automatic FMCLV002002(C) - 4-speed

1970-76 Duster - Duster w/ Duster Logo  
FMCLV003001(C) - Automatic FMCLV003002(C) - 4-speed

1970-76 Duster - Block letters  
FMCLV006001(C) - Automatic FMCLV006002(C) - 4-speed

1970-75 Gold Duster - Block letters  
FMCLV007001(C) - Automatic FMCLV007002(C) - 4-speed

1971-74 Twister - Twister Logo  
FMCLV008001(C) - Automatic FMCLV008002(C) - 4-speed

1967-76 Pentastar  
FMCDP005001(C) - Automatic FMCDP005002(C) - 4-speed

**FLOORMAT PRICING:**  
**ALL COLORS - \$189.00/set**

1967-76 Pentastar



1967-69 Valiant 100



1967-69 Valiant Signet



1971-76 Scamp



1970-76 Duster



1970-76 Duster



1970-75 Gold Duster



1971-74 Duster Twister





# 1967-76 DODGE DART & DEMON



1967-68 Dart - Block letters w/ Dodge emblem  
FMCLV009001(C) - Automatic FMCLV009002(C) - 4-speed

1967 Dart GT - Block letters w/ GT  
FMCLV010001(C) - Automatic FMCLV010002(C) - 4-speed

1968 Dart GT - Block letters w/ GT  
FMCLV011001(C) - Automatic FMCLV011002(C) - 4-speed

1968 Dart GTS - Block letters  
FMCLV012001(C) - Automatic FMCLV012002(C) - 4-speed

1969 Dart GT - Block letters w/ GT  
FMCLV013001(C) - Automatic FMCLV013002(C) - 4-speed

1969 Dart GTS - Block letters  
FMCLV014001(C) - Automatic FMCLV014002(C) - 4-speed

1969-76 Dart - Block letters w/ Dodge emblem  
FMCLV015001(C) - Automatic FMCLV015002(C) - 4-speed

1969-76 Dart Swinger - Block letters w/ Swinger script  
FMCLV001001(C) - Automatic FMCLV001002(C) - 4-speed

1973-76 Dart Sport - Block letters  
FMCLV005001(C) - Automatic FMCLV005002(C) - 4-speed

1971-72 Demon - Demon logo  
FMCLV004001(C) - Automatic FMCLV004002(C) - 4-speed

1967-76 Pentastar  
FMCDP005001(C) - Automatic FMCDP005002(C) - 4-speed

**FLOORMAT PRICING:**  
**ALL COLORS - \$189.00/set**

1967-76 Pentastar



1967-68 Dart



1967 Dart GT



1968 Dart GT



1968 Dart GTS



1969 Dart GT



1969 Dart GTS



1969-76 Dart



1969-76 Dart Swinger



1973-76 Dart Sport



1971-72 Demon



# 1967-69 PLYMOUTH BARRACUDA & CUDA

**NEW DESIGN  
COMING SOON!!**



1967-69 Barracuda - Script letters w/ Fish emblem  
FMCU0009001(C) - Automatic FMCU0009002(C) - 4-speed

1967-69 Barracuda - Script letters w/ Formula S emblem  
FMCU0010001(C) - Automatic FMCU0010002(C) - 4-speed

1967-69 Pentastar  
FMCDP005001(C) - Automatic FMCDP005002(C) - 4-speed

**FLOORMAT PRICING:  
ALL COLORS - \$189.00/set**

1967-69 Pentastar



1967-69 Barracuda



1967-69 Formula S



# 1970-74 PLYMOUTH BARRACUDA & CUDA

**SURE-GRIP™**  
CONTRA ANTI-SKID BACKING



[www.legendariautointeriors.com](http://www.legendariautointeriors.com)

**FLOORMAT PRICING:**  
**ALL COLORS - \$249.00/set**



**ALL NEW DESIGN!!**

**1970 Barracuda by Plymouth**

FMCU0002001(C) - Automatic FMCU0002002(C) - 4-speed

**1970 Barracuda Gran Coupe**

FMCU0003001(C) - Automatic FMCU0003002(C) - 4-speed

**1971 Barracuda Gran Coupe**

FMCU0008001(C) - Automatic FMCU0008002(C) - 4-speed

**1971-74 Barracuda by Plymouth**

FMCU0007001(C) - Automatic FMCU0007002(C) - 4-speed

**1970 AAR Cuda**

FMCU0004001(C) - Automatic FMCU0004002(C) - 4-speed

**1970-74 Cuda**

FMCU0005001(C) - Automatic FMCU0005002(C) - 4-speed

**1970-74 Cuda by Plymouth**

FMCU0006001(C) - Automatic FMCU0006002(C) - 4-speed

**1970-74 Pentastar**

FMCDP006001(C) - Automatic FMCDP006002(C) - 4-speed

1970-74 Pentastar



1970 Barracuda



1970 Barracuda Gran Coupe

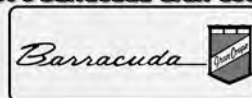

1971-74 Barracuda



1971 Barracuda Gran Coupe



1970-74 Cuda



1970 AAR Cuda



1970-74 Cuda by Plymouth

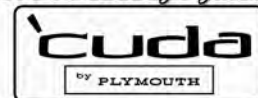

# 1970-74 DODGE CHALLENGER

**SURE-GRIP™**  
CONYIC ANTI-SKID BACKING



[www.legendariautointeriors.com](http://www.legendariautointeriors.com)

**FLOORMAT PRICING:**  
**ALL COLORS - \$249.00/set**



**ALL NEW DESIGN!!**

<b>1970-74 Challenger</b> FMCH0002001(C) - Automatic	FMCH0002002(C) - 4-speed
<b>1970 Challenger SE</b> FMCH0003001(C) - Automatic	FMCH0003002(C) - 4-speed
<b>1970 Challenger T/A</b> FMCH0004001(C) - Automatic	FMCH0004002(C) - 4-speed
<b>1970-71 Challenger R/T</b> FMCH0005001(C) - Automatic	FMCH0005002(C) - 4-speed
<b>1970-74 Pentastar</b> FMCDP006001(C) - Automatic	FMCDP006002(C) - 4-speed

1970-74 Challenger



1970 Challenger SE

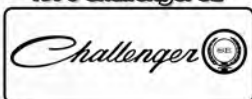

1970 Challenger T/A



1970-71 Challenger R/T



1970-74 Pentastar



# ORIGINAL STYLE CHRYSLER & AMC



1970-76 A-Body & 1976-80 F-Body  
FMOR70CLV000(C)

**FLOORMAT PRICING:**  
**ALL COLORS - \$149.00/set**



1968-70 AMX/Javelin  
FMOR68AAJ(C)



**FLOORMAT PRICING:**  
**ALL COLORS - \$289.00/set**



# Chrysler, Dodge, Plymouth

## OEM FIREWALL INSULATION

Firewalls are cut and punched with standard factory holes and are shipped ready-to-install with the appropriate "period" insulation attached.

<b>1963-66 A-Body</b> 	
<b>FI63CBLVO</b> (no air).....	\$179.00/pr.
<b>1967-69 A-Body</b> 	
<b>FI67CBLVO</b> (no air).....	\$179.00/pr.
<b>1970-74 E-Body</b> 	
<b>FI70CBJO</b> (no air).....	\$179.00/pr.

## KICK PANELS

Reproduction plastic kick panels for 1970-74 E-Body models. Available in black or colors in deluxe "OEM" and standard.





**1970-74 E-Body (all models) (shown)**

<b>KI70CBJ100</b> (Black).....	\$159.00/pr.
<b>KI70CBJ200</b> (White).....	\$159.00/pr.
<b>KI70CBJ338</b> (Bright Blue).....	\$159.00/pr.
<b>KI70CBJ340</b> (Bright Blue).....	\$159.00/pr.
<b>KI70CBJ360</b> (Lagoon Blue).....	\$159.00/pr.
<b>KI70CBJ434</b> (Dark Metallic Green).....	\$159.00/pr.
<b>KI70CBJ444</b> (Dark Green).....	\$159.00/pr.
<b>KI70CBJ450</b> (Jade Green).....	\$159.00/pr.
<b>KI70CBJ452</b> (Dark Metallic Green).....	\$159.00/pr.
<b>KI70CBJ540</b> (Burnt Orange).....	\$159.00/pr.
<b>KI70CBJ550</b> (Red).....	\$159.00/pr.
<b>KI70CBJ656</b> (Brown).....	\$159.00/pr.
<b>KI70CBJ664</b> (Brown).....	\$159.00/pr.
<b>KI70CBJ666</b> (Ember Gold).....	\$159.00/pr.

## FIREWALL INSULATION



Die-cut from black fiberboard with yellow insulation attached to properly fit the firewall. Clips included.

<b>1962 Valiant</b>	
<b>FI62CVWIO</b> (no air) <b>NEW!!!</b> .....	\$79.00/kit
<b>1964-66 Dart</b>	
<b>FI64CLWIA</b> (with air) <b>NEW!!!</b> .....	\$49.00/kit
<b>1964-66 Barracuda/Valiant</b>	
<b>FI64CVAWIO</b> (automatic / no air).....	\$49.00/kit
<b>FI64CV4SPWIO</b> (manual / no air).....	\$49.00/kit
<b>1967-69 Barracuda</b>	
<b>FI67CBWIO</b> (no air) <b>NEW!!!</b> .....	\$49.00/kit
<b>FI67CBWIA</b> (with air) <b>NEW!!!</b> .....	\$69.00/kit
<b>1967-76 Dart, Duster, Demon</b> 	
<b>Dart Sport</b>	
<b>FI67CBLVWIO</b> (no air).....	\$49.00/kit
<b>FI67CBLVWIA</b> (with air).....	\$59.00/kit
<b>1970-74 E-Body (all models)</b> 	
<b>FI70CBJWIO</b> (no air).....	\$49.00/kit
<b>FI70CBJWIA</b> (with air).....	\$49.00/kit
<b>1965-68 C-Body (all models)</b> 	
<b>FI65CFMPWIA</b> (with air).....	\$69.00/kit
<b>1967-71 Dodge Truck</b>	
<b>FI67CDTWIO</b> (no air).....	\$79.00/kit
<b>1972-80 Dodge Truck</b>	
<b>FI72CDTWIO</b> (no air).....	\$69.00/kit

## KICK PANEL INSULATION

Die-cut from the correct yellow insulation to properly fit behind the kick panels and reduce road noise.









<b>1963-66 Dart</b>	
<b>KI63CL</b> .....	\$49.00/kit
<b>1964-66 Valiant</b>	
<b>KI64CV</b> .....	\$39.00/kit
<b>1964-66 Barracuda</b>	
<b>KI64CB</b> .....	\$49.00/kit
<b>1967-69 Dart, Barracuda &amp; Valiant</b>	
<b>KI67CBLV</b> (shown).....	\$39.00/kit
<b>1970-76 A-Body (all models)</b>	
<b>KI70CLV</b> .....	\$29.00/kit
<b>1970-74 E-Body (all models)</b>	
<b>KI70CBJ</b> .....	\$19.00/kit

## SOUND DAMPENING





Kits are designed on current "state-of-the-art" auto acoustic technology, to insulate and control the noise, vibration and heat.

### 1963-66 A-BODY

**Hardtop/Coupe**







<b>SD63CLV-H (Dampening Kit)</b> 	\$949.00/ea.
<i>Kit includes Body Panel, Cowl, Floor, Roof &amp; Trunk</i>	
<b>SD63CLV-BPK (Body Panel)</b> 	\$189.00/ea.
<b>SD63CLV-CK (Cowl)</b> 	\$89.00/ea.
<b>SD63CLV-FK (Floor)</b> 	\$339.00/ea.
<b>SD63CLV-RK (Roof)</b> 	\$189.00/ea.
<b>SD63CLV-TK (Trunk)</b> 	\$189.00/ea.

**Convertible**



<b>SD63CLV-V (Dampening Kit)</b> 	\$789.00/ea.
<i>Kit includes Body Panel, Cowl, Floor &amp; Trunk pieces.</i>	
<b>SD63CLV-VBPK (Body Panel)</b> 	\$189.00/ea.
<b>SD63CLV-VCK (Cowl)</b> 	\$89.00/ea.
<b>SD63CLV-VFK (Floor)</b> 	\$339.00/ea.
<b>SD63CLV-VTK (Trunk)</b> 	\$189.00/ea.

### 1967-69 A-BODY

**Hardtop/Coupe**







<b>SD67CBLV-H (Dampening Kit)</b> 	\$949.00/ea.
<i>Kit includes Body Panel, Cowl, Floor, Roof &amp; Trunk</i>	
<b>SD67CBLV-BPK (Body Panel)</b> 	\$189.00/ea.
<b>SD67CBLV-CK (Cowl)</b> 	\$89.00/ea.
<b>SD67CBLV-FK (Floor)</b> 	\$339.00/ea.
<b>SD67CBLV-RK (Roof)</b> 	\$189.00/ea.
<b>SD67CBLV-TK (Trunk)</b> 	\$189.00/ea.

**Convertible**

<b>SD67CBLV-V (Dampening Kit)</b> 	\$789.00/ea.
<i>Kit includes Body Panel, Cowl, Floor &amp; Trunk pieces.</i>	
<b>SD67CBLV-VBPK (Body Panel)</b> 	\$189.00/ea.
<b>SD67CBLV-VCK (Cowl)</b> 	\$89.00/ea.
<b>SD67CBLV-VFK (Floor)</b> 	\$339.00/ea.
<b>SD67CBLV-VTK (Trunk)</b> 	\$189.00/ea.

### 1970-76 A-BODY







**Hardtop/Coupe**

<b>SD70CLV-H (Dampening Kit)</b> 	\$999.00/ea.
<i>Kit includes Body Panel, Cowl, Floor, Roof &amp; Trunk</i>	
<b>SD70CLV-BPK (Body Panel)</b> 	\$189.00/ea.
<b>SD70CLV-CK (Cowl)</b> 	\$129.00/ea.
<b>SD70CLV-FK (Floor)</b> 	\$339.00/ea.
<b>SD70CLV-RK (Roof)</b> 	\$189.00/ea.
<b>SD70CLV-TK (Trunk)</b> 	\$189.00/ea.

## SOUND DAMPENING CONT.







### 1964-66 BARRACUDA

#### Fastback Models

<b>SD64CB-F (Dampening Kit)</b> 	\$949.00/ea.
<i>Kit includes Body Panel, Cowl, Floor, Roof &amp; Trunk pieces.</i>	
<b>SD64CB-FBPK (Body Panel)</b> 	\$219.00/ea.
<b>SD64CB-FCK (Cowl)</b> 	\$89.00/ea.
<b>SD64CB-FFK (Floor)</b> 	\$339.00/ea.
<b>SD64CB-FRK (Roof)</b> 	\$189.00/ea.
<b>SD64CB-FTK (Trunk)</b> 	\$189.00/ea.







### 1967-69 BARRACUDA

#### Fastback Models





<b>SD67CB-F (Dampening Kit)</b> 	\$949.00/ea.
<i>Kit includes Body Panel, Cowl, Floor, Roof &amp; Trunk pieces.</i>	
<b>SD67CB-FBPK (Body Panel)</b> 	\$219.00/ea.
<b>SD67CB-FCK (Cowl)</b> 	\$89.00/ea.
<b>SD67CB-FFK (Floor)</b> 	\$339.00/ea.
<b>SD67CB-FRK (Roof)</b> 	\$189.00/ea.
<b>SD67CB-FTK (Trunk)</b> 	\$189.00/ea.

### 1970-74 E-BODY

#### Hardtop Models

<b>SD70CBJ-H (Dampening Kit)</b> 	\$949.00/ea.
<i>Kit includes Body Panel, Cowl, Floor, Roof &amp; Trunk pieces.</i>	
<b>SD70CBJ-BPK (Body Panel)</b> 	\$189.00/ea.
<b>SD70CBJ-CK (Cowl)</b> 	\$89.00/ea.
<b>SD70CBJ-FK (Floor)</b> 	\$339.00/ea.
<b>SD70CBJ-RK (Roof)</b> 	\$189.00/ea.
<b>SD70CBJ-TK (Trunk)</b> 	\$189.00/ea.



#### Convertible

<b>SD70CBJ-V (Dampening Kit)</b> 	\$789.00/ea.
<i>Kit includes Body Panel, Cowl, Floor &amp; Trunk pieces.</i>	
<b>SD70CBJ-VBPK (Body Panel)</b> 	\$189.00/ea.
<b>SD70CBJ-VCK (Cowl)</b> 	\$89.00/ea.
<b>SD70CBJ-VFK (Floor)</b> 	\$339.00/ea.
<b>SD70CBJ-VTK (Trunk)</b> 	\$189.00/ea.

## SOUND DEADENER

This rubber/tar material installs under the carpet to reduce heat and noise. Pre-cut to correct shape and size.

#### 1967-76 A-Body (all models)

<b>1970-74 E-Body (all models)</b> 	
<b>SD66CABE</b> .....	\$99.00/ea.
<b>1972/80 Dodge Truck</b> 	
<b>SD72CDT</b> .....	\$89.00/ea.

## DOOR SILL PLATES



Machine stamped aluminum sill plates cover the edge of the carpet securing it to the lower door frame section. Available for 2-door models only. \* Do not come with screws, must supply own.

<b>1963-66 A-Body</b>	
<b>SP63CBLV</b> .....	\$119.00/pr.
<b>1967-74 A-Body</b>	
<b>SP67CBLV</b> .....	\$129.00/pr.
<b>1970-74 E-Body</b>	
<b>SP70CBJ (Repro)</b> .....	\$129.00/pr.



# DASHES, CONSOLES AND ACCESORIES

 [facebook.com/legendaryautointeriors](https://facebook.com/legendaryautointeriors)

 [twitter.com/legendaryautoin](https://twitter.com/legendaryautoin)

 [www.legendaryautointeriors.com](http://www.legendaryautointeriors.com)

 [instagram.com/legendaryautointeriorsltd](https://instagram.com/legendaryautointeriorsltd)

 [youtube.com/user/legendaryauto](https://youtube.com/user/legendaryauto)

# Chrysler, Dodge, Plymouth

## A-BODY DASH PADS

Reproduction dash pads for 1969-76 A-Body models feature original Cologne grain finish. Available in black only.

### 1969-76 A-Body (all models)

DP69CBLV01 .....\$439.00/ea.

## UNDERDASH INSULATION

Die-cut to original specifications, this insulation eliminates underdash noise and vibration.

### 1967-76 A-Body (all models)

UD67CBLV .....\$29.00/kit

### 1970-74 E-Body (all models)

UD70CBJ .....\$29.00/kit

## E-BODY "SHAKER" UNDER DASH CABLE

One of the two cables that operate the cold and warm air doors on the E-Body (Challenger & Barracuda) Shaker hood. Includes the foil "CARB AIR" applique and the firewall grommet.

### 1970-71 E-Body "Shaker"

UD70E-HCD .....\$79.00/ea.

## DASH PAD SPEAKER GRILL

Reproduction speaker grill insert for 1970-74 Barracuda and Challenger models. This grill insert covers the center speaker on the top of the dash pad protecting it from damage. Fits the center speaker only on both 1 and 3 speaker models. Available in black only but can be painted to match interior colors.



### 1970 Challenger

DP70CJSPGRILL01 .....\$99.00/ea.

Fits center speaker only on 3 speaker dash pads.

### 1970-74 Barracuda 1971-74 Challenger

DP70CBJSPGRILL01 .....\$99.00/ea.

Fits center speaker only on 3 speaker dash pads.

## E-BODY "SHAKER" UNDER HOOD CABLE

One of the two cables that operate the cold and warm air doors on the E-Body (Challenger & Barracuda) Shaker hood. Includes the foil "CARB AIR" applique and the firewall grommet.

### 1970-71 E-Body "Shaker"

UD70E-HC .....\$39.00/ea.

## HEMI CHOKE CABLE

Underdash cable that operates the choke on 1971 Hemi cars. Includes correct foil "CHOKE" applique and firewall grommet.

### 1971 B & E-Body HEMI

UD71BE-HEMI .....\$88.00/ea.

## DASH PAD EMBLEMS

Reproduction emblems with adhesive back for ease of installation.



### 1971-74 Barracuda

DP71CB-EMBLEM ..... discontinued



### 1971 Challenger

DP71CJ-EMBLEM ..... discontinued

## "CHOKE" APPLIQUE

Correct red foil "CHOKE" applique for underdash cable that operates the choke on 1971 Hemi cars.

### 1971 E-Body

UD71BE-CHOKE .....\$12.00/ea.

## VENT CABLES



Underdash vent cable with correct "square" knob and white VENT marking for 1970 E-Bodies with and without AC.

### 1970 E-Body

UD70E-VCL (left hand) .....\$79.00/ea.

UD70E-VCR (right hand) .....\$79.00/ea.



Underdash vent cable with correct round knob knurled edge for 1971 E-Bodies without AC.

### 1971 E-Body

UD71E-VCL (left hand) .....\$69.00/ea.

UD71E-VCR (right hand) .....\$69.00/ea.

## PILLAR POST MOLDINGS



Reproduction plastic pillar post moldings for 1970-74 E-Body models.

### 1967-72 Dart & 1967-69 Cuda

PP67CBL100 .....\$169.00/pr.

### 1970-Early 1971 E-Body (Injection Molded As-Original)

PP70CBJM100 .....\$169.00/pr.

### Mid 1971-74 E-Body (Injection Molded As-Original)

PP71CBJM100 .....\$169.00/pr.





## CONSOLE SHIFTER SLIDE



Reproduction shifter slide seal for 1967-1976 A-Body and 1966-1970 B & C-Body models with console shifted automatics.

**TN66AB-SLIDE** ..... \$22.00/ea.

## CONSOLE CARPET KITS

Carpet kits for A-Body bucket seat interiors with center console option. Ready to install kits come with fully bound carpet attached to die-cut panel board as original where applicable by year.

### A-BODY MODELS

**1966-76 A-Body**  
**CC66CBLVA(C)** (automatic) ..... \$93.00/kit

**1966 A-Body**  
**CC66CBLVS(C)** (manual) ..... \$93.00/kit

**1967-69 A-Body**  
**CC67CBLVS(C)** (manual) ..... \$93.00/kit

**1970-76 A-Body**  
**CC70CLVS(C)** (manual) ..... \$93.00/kit

## WOODGRAIN CONSOLE INSERTS



Die-cut vinyl woodgrain inserts for automatic and 4-speed models made in original grain and color. Adhesive backing makes them easy to install.

### A-BODY MODELS

**1967-69 (all models)**  
**WC67AA** (automatic) ..... \$39.00/ea.  
**WC67AS** (manual) ..... \$29.00/ea.  
 Will fit 1968 models but features incorrect woodgrain style. 1968 used Burlwood which is N/A.

**1970-76 (all models)**  
**WC70AA** (automatic) (shown) ..... \$39.00/ea.  
**WC70AS** (manual) ..... \$29.00/ea.

### E-BODY MODELS

**1970-74 (all models)**  
**WC70EBA** (automatic) ..... \$39.00/ea.  
**WC70EBS** (manual) ..... \$39.00/ea.

## 70-74 E-BODY CONSOLES

Injection mold plastic console body for 1970-74 E-Body models. Available for automatic and 4-speed models. Molded in black plastic to original specifications and correct grain. Original hardware must be reused. For console carpet kits please see above.

**1970 E-Body**   
**CS70EA** (Automatic) ..... \$340.00/ea.  
**CS70ES** (4-speed) ..... \$360.00/ea.

**1971-74 B & E-Body**   
**CS71BEA** (Automatic) ..... \$299.00/ea.  
**CS71BES** (4-Speed) ..... \$299.00/ea.



## DOMELIGHT LENS



Round plastic dome light lens for 1966-74 A & E-Body models.

**LL66ABCE-DOME** ..... \$10.00/ea.

## COURTESY LIGHT LENSES

Round plastic courtesy light lenses located on the sail panels for 1964-66 A-Body models.

**LL65BC-CRTSY** ..... \$29.00/pr.

## 68-70 HORN BUTTON



Horn button for 1968-70 A-Body models with woodgrain steering wheels. Original grain texture. Available in black only but can be dyed to match interior colors.

**1968-70 A-Body (all models)**  
**SW68C-HB** (shown) ..... \$69.00/ea.

## WOODGRAIN DASH INSERTS



Die-cut vinyl woodgrain inserts are made with the closest match to the original in grain and color. Adhesive backing makes them easy to install.

**1968-69 Barracuda**  
**WC68AC** (Rally dash) ..... \$39.00/ea.  
 Will fit 1968 models but features incorrect woodgrain style. 1968 used Burlwood which is N/A.

**1970-71 Dart, Duster & Demon**  
**WC70AAC** (Rally dash) ..... \$29.00/ea.

**1970 Challenger**  
**WC70CJ3D** (3 cluster) ..... \$39.00/ea.  
**WC70CJ4D** (4 cluster) (shown) ..... \$39.00/ea.  
 Hardtop models w/o rear defrost use 3 cluster style.  
 Conv. & hardtop models with rear defrost use 4 cluster style.

**1971-74 Challenger**  
**WC71CJ3D** (3 cluster) ..... \$49.00/ea.  
**WC71CJ4D** (4 cluster) ..... \$39.00/ea.  
 Hardtop models w/o rear defrost use 3 cluster style.  
 Conv. & hardtop models with rear defrost use 4 cluster style.

**1970 Barracuda**  
**WC70CB3D** (3 cluster) ..... \$39.00/ea.  
**WC70CB4D** (4 cluster) ..... \$39.00/ea.  
 Hardtop models w/o rear defrost use 3 cluster style.  
 Conv. & hardtop models with rear defrost use 4 cluster style.

**1973-74 Barracuda**  
**WC73CB3D** (3 cluster) ..... \$49.00/ea.  
**WC73CB4D** (4 cluster) ..... \$49.00/ea.  
 Hardtop models w/o rear defrost use 3 cluster style.  
 Hardtop models with rear defrost use 4 cluster style.

## DASH VENTS

Exact duplicates of the original dash vents found on the top portion of the dash. Available in black only but can be painted to match interior colors. Fastening nuts included.



**1963-66 A-Body (all models)**  
**DP62C-VENT** ..... \$89.00/pr.

**1967-76 A-Body (all models)**  
**DP67CBLV-VENT** (shown) ..... \$79.00/pr.

**1972-80 Dodge Truck**  
**DP62C-VENT** ..... \$89.00/pr.

## DASH VENT HOSE KITS

Dash vents and fastening nuts (same as above) with new reproduction vent hoses. Kits include 2 vents with fastening nuts and 2 hoses with clips.



**1963-66 A-Body (all models)**  
**DP62C-VHKIT** ..... \$139.00/pr.

**1967-76 A-Body (all models)**  
**DP67CBLV-VHKIT** ..... \$139.00/pr.

**1972-80 Dodge Truck**  
**DP62C-VHKIT** ..... \$139.00/pr.

# Chrysler, Dodge, Plymouth

## GLOVEBOX LINERS

Glovebox liners are die-cut and pre-stapled with mounting hardware attached for easy installation. Fuse box doors included where applicable.



### A-BODY MODELS

- 1960-62 Valiant**  
GB60CV .....\$39.00/ea.
- 1963-66 Dart**  
GB63CL .....\$29.00/ea.
- 1963-66 Valiant**  
GB63CV .....\$29.00/ea.
- 1964-66 Barracuda**  
GB64CB .....\$29.00/ea.
- 1967 Dart & Barracuda**  
GB67CLB .....\$29.00/ea.
- 1968-69 Barracuda**  
**1968-74 Dart & Scamp**  
**1970-76 Duster, Demon, Dart Sport**  
GB68CLVB .....\$29.00/ea.

### E-BODY MODELS

- 1970-74 Barracuda & Challenger**  
GB70BJ .....\$29.00/ea.

### DODGE TRUCK & VAN

- 1961-66 Dodge Truck**  
GB61CDT .....\$29.00/ea.
- 1967-71 Dodge Truck**  
GB67CDT .....\$29.00/ea.
- 1964-70 A-100 Van**  
GB64CDV .....\$29.00/ea.

## AUTOMATIC SHIFTER KNOB



Reproduction woodgrain shifter knob used in selected 1969-74 A & E-Body models with console-shifted automatics. Black push button and spring included in kit.

- TN69AABE-SHIFT** .....\$79.00/kit

## PISTOL GRIP SHIFTER & LENS



Reproduction injection-molded plastic pistol grip shifter for 1970-74 B & E-Body 4-speed models. Pistol and lens sold separately.

- TN70BE4SP-GRIP** .....\$89.00/ea.
- TNGRIPLENS** .....\$15.00/ea.

## SHIFTER BOOTS & BEZEL

Rubber shifter boots and bezels as original. Upper boots are for models equipped with center consoles while lower boots are for manual transmission models without a center console. Lower shift boots use a bezel that feature a chrome finish as the originals.

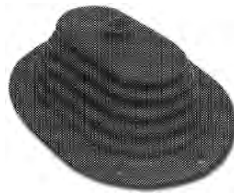

- 1967-76 A-Body (all models)**  
**TN67A-BOOT-L (w/o console)** .....\$59.00/ea.



- 1970-74 E-Body (all models)**  
**TN70BE-BOOT-L (w/o console)** .....\$69.00/ea.



- 1970-74 E-Body (all models)**  
**TN70BE-BOOTBEZ (w/o console)** .....\$29.00/ea.

## SHIFTER BOOTS & BEZELS



Clutch release fork boot for 1964-74 A & E-Body 4-Speed & 3-Speed column shift

- 1964-74 A,B,C & E-Body**  
**TN64ABCE-BOOT** .....\$39.00/ea.

## 4-SPEED SHIFTER KNOB



Woodgrain shifter knob made of plastic for 1968-1969 A-Body 4-speed models. Features a correct woodgrain texture and 4-speed pattern.

- TN68AB4SP-BALL** .....\$79.00/ea.

## PEDAL PADS & BEZELS

Reproduction pedal pads and bezels for accelerators, brake/clutch and parking brake on A & E-Body models.

### ACCELERATORS & BEZELS



- 1963-66 A-Body**  
**PB63AB-A (pad w/ raised dots)** .....\$59.00/ea.

- 1970 E-Body**  
**PB70CBJ-A (pad)** .....\$69.00/ea.
- PB70E-ABEZ (bezel) (shown)** .....\$19.00/ea.

### 4-SPEED CLUTCH /BRAKE PADS & BEZELS



- 1963-66 A-Body**  
**PB63AB4SP-B/C (pad w/ dots)** .....\$19.00/ea.

- 1966-71 A-Body**  
**PB66AB4SP-B/C (pad)** .....\$39.00/pr.
- PB66AB4SP-B/CBEZ (bezel) (shown)** ..\$29.00/pr.

- 1970-72 E-Body**  
**PB70BE4SP-B/C (pad) (shown)** .....\$29.00/ea.
- PB70BE4SP-B/CBEZ (bezel)** .....\$15.00/ea.

- 1972-76 A-Body**  
**1973-74 E-Body**  
**PB71ABE4SP-B/C (pad)** .....\$10.00/ea.

### AUTOMATIC BRAKE PADS & BEZELS



- 1963-66 A-Body**  
**PB63ABA-B (pad w/ raised dots)** .....\$39.00/ea.

- 1966-71 A-Body**  
**PB66ABA-B (pad) (shown)** .....\$39.00/ea.
- PB66ABA-BBEZ (bezel) (shown)** .....\$29.00/ea.

- 1970-72 E-Body**  
**PB70BEA-B (pad)** .....\$19.00/ea.
- PB70BEA-BBEZ (bezel)** .....\$19.00/ea.

### PARKING BRAKE PADS



- 1963-66 A-Body**  
**PB63AB-P (pad w/ dots) (shown)** .....\$19.00/ea.

- 1967-71 A-Body**  
**PB66AB-P (pad)** .....\$29.00/ea.
- PB66AB-PBEZ (bezel) (shown)** .....\$15.00/ea.

- 1970-74 E-Body**  
**PB70BE-P (pad)** .....\$29.00/ea.
- PB70BE-PBEZ (bezel)** .....\$15.00/ea.





# HEADLINERS AND TRIM ACCESORIES

 [facebook.com/legendaryautointeriors](https://facebook.com/legendaryautointeriors)

 [twitter.com/legendaryautoin](https://twitter.com/legendaryautoin)

 [www.legendaryautointeriors.com](http://www.legendaryautointeriors.com)

 [instagram.com/legendaryautointeriorsltd](https://instagram.com/legendaryautointeriorsltd)

 [youtube.com/user/legendaryauto](https://youtube.com/user/legendaryauto)

# Headliner Grains and Colors

Legendary Auto Interiors headliners are manufactured to original specifications and are available in a variety of colors in Perforated or Non-Perforated pattern. Each headliner is assembled with heavy-duty stitching.

If your year/model is not listed please contact our sales department for assistance on availability. Please specify perforated or non-perforated at time of order. Sample approval is highly recommended for colors other than black.

## STANDARD style

### Non-Perforated

<b>01</b> <b>Black</b>	<b>02</b> <b>White</b>	<b>03</b> <b>Red</b>	<b>07</b> <b>Dark Blue</b>
<b>11</b> <b>Medium Blue</b>	<b>13</b> <b>Dark Green</b>	<b>17</b> <b>Buckskin</b>	<b>18</b> <b>Light Blue</b>
<b>20</b> <b>Bright Red</b>	<b>31</b> <b>Maroon</b>	<b>38</b> <b>Sandalwood</b>	<b>98</b> <b>Brown</b>

### Perforated

<b>01</b> <b>Black</b>	<b>02</b> <b>White</b>	<b>03</b> <b>Red</b>	<b>07</b> <b>Dark Blue</b>
<b>11</b> <b>Medium Blue</b>	<b>13</b> <b>Dark Green</b>	<b>17</b> <b>Buckskin</b>	<b>18</b> <b>Light Blue</b>
<b>20</b> <b>Bright Red</b>	<b>31</b> <b>Maroon</b>	<b>38</b> <b>Sandalwood</b>	<b>98</b> <b>Brown</b>

## OEM style

Legendary Auto Interiors, Ltd. is pleased to announce another first in the industry. "As Original" headliners and sail panels are now available for 1965-66 and 1969-72 Dodge, Plymouth and Chrysler cars. All new headliner styles have a heavier cotton/poly cloth backing with more vibrant colors and finishes like the ORIGINAL!! This will assure longevity to these new products as the vinyl and backing are much higher quality than other vinyls offered in today's automotive marketplace.

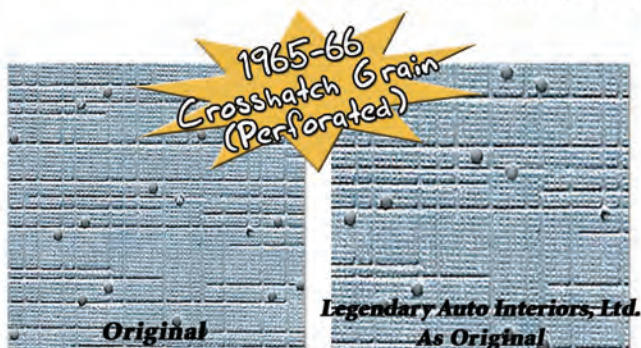

<b>101</b> <b>Black</b>	<b>102</b> <b>White</b>
<b>111</b> <b>Light Met. Blue</b>	<b>121</b> <b>Metallic Red</b>

<b>101</b> <b>Black</b>	<b>102</b> <b>White</b>	<b>107</b> <b>Dark Blue</b>
<b>110</b> <b>Bright Blue</b>	<b>113</b> <b>Dark Green</b>	<b>122</b> <b>Burnt Orange</b>

HEADLINERS

A-BODY MODELS

1963 Dart GT

Hardtop - (Perforated Grain)  
 HL63CL01 (Black).....\$169.00/ea.  
 HL63CL02 (White).....\$169.00/ea.

1963 Valiant

Hardtop 2-Door (Signet 200)  
 Sedan 2 & 4-Door - (Perforated Grain)  
 HL63CV01 (Black).....\$169.00/ea.  
 HL63CV02 (White).....\$169.00/ea.  
 HL63CV11 (Medium Blue).....\$169.00/ea.

1964-66 Dart GT

Hardtop - (Perforated Grain)  
 HL64CL01 (Black).....\$169.00/ea.  
 HL64CL02 (White).....\$169.00/ea.  
 HL64CL11 (Medium Blue).....\$169.00/ea.  
 HL64CL20 (Medium Red).....\$169.00/ea.

Hardtop - OEM Style - (Crosshatch Grain)

HL64CL101 (Black).....\$259.00/ea.  
 HL64CL102 (White).....\$259.00/ea.  
 HL64CL111 (Light Metallic Blue).....\$259.00/ea.  
 HL64CL121 (Metallic Red).....\$259.00/ea.

1964-66 Barracuda

Fastback - (Perforated Grain)  
 HL64CB01F (Black).....\$169.00/ea.  
 HL64CB02F (White).....\$169.00/ea.  
 HL64CB07F (Dark Blue).....\$169.00/ea.  
 HL64CB11F (Medium Blue).....\$169.00/ea.  
 HL64CB20F (Bright Red).....\$169.00/ea.

1965-66 Fastback - OEM Style (Crosshatch Grain)

HL65CB101F (Black).....\$255.00/ea.  
 HL65CB102F (White).....\$255.00/ea.  
 HL65CB111F (Light Metallic Blue).....\$255.00/ea.  
 HL65CB121F (Metallic Red).....\$255.00/ea.

1964 Valiant

Hardtop - (Perforated Grain)  
 HL64CV01 (Black).....\$169.00/ea.  
 HL64CV02 (White).....\$169.00/ea.

1965 Valiant Signet, Valiant 100 & 200

Hardtop & Sedan - (Perforated Grain)  
 HL65CVS01 (Black).....\$169.00/ea.  
 HL65CVS20 (Bright Red).....\$169.00/ea.  
 Hardtop & Sedan - OEM - (Crosshatch Grain)  
 HL65CVS101 (Black).....\$255.00/ea.  
 HL65CVS111 (Light Metallic Blue).....\$255.00/ea.

1966 Valiant Signet

Hardtop - (Perforated Grain)  
 HL66CVS01 (Black).....\$169.00/ea.  
 HL66CVS03 (Red).....\$169.00/ea.  
 HL66CVS11 (Medium Blue).....\$169.00/ea.  
 Hardtop - OEM Style - (Crosshatch Grain)  
 HL66CVS101 (Black).....\$255.00/ea.  
 HL66CVS111 (Light Metallic Blue).....\$255.00/ea.

1967-76 Dart & Dart GT

Hardtop - (Perforated Grain)  
 HL67CL01 (Black).....\$169.00/ea.  
 HL67CL02 (White).....\$169.00/ea.  
 HL67CL03 (Red).....\$169.00/ea.  
 HL67CL07 (Dark Blue).....\$169.00/ea.  
 HL67CL11 (Medium Blue).....\$169.00/ea.  
 HL67CL13 (Dark Green).....\$169.00/ea.  
 HL67CL17 (Buckskin).....\$169.00/ea.  
 HL67CL38 (Sandalwood).....\$169.00/ea.  
 HL67CL98 (Brown).....\$169.00/ea.

1967-76 Dart & Dart GT

1969-72 Hardtop - OEM Style (Fine Pembroke Grain)  
 HL67CL101 (Black).....\$209.00/ea.  
 HL67CL102 (White).....\$209.00/ea.  
 HL67CL107 (Dark Blue).....\$209.00/ea.  
 HL67CL110 (Bright Blue).....\$209.00/ea.  
 HL67CL113 (Green).....\$209.00/ea.

1967-72 Dart

2 & 4 Door Sedan - (Perforated Grain)  
 HL67CLV01 (Black).....\$169.00/ea.  
 HL67CLV02 (White).....\$169.00/ea.  
 HL67CLV07 (Dark Blue).....\$169.00/ea.  
 HL67CLV11 (Medium Blue).....\$169.00/ea.  
 HL67CLV13 (Dark Green).....\$169.00/ea.  
 HL67CLV17 (Buckskin).....\$169.00/ea.  
 HL67CLV18 (Light Blue).....\$169.00/ea.  
 HL67CLV31 (Maroon).....\$169.00/ea.

1969-72 - OEM Style - (Fine Pembroke Grain)

HL67CLV101 (Black).....\$209.00/ea.  
 HL67CLV102 (White).....\$209.00/ea.  
 HL67CLV107 (Dark Blue).....\$209.00/ea.  
 HL67CLV110 (Bright Blue).....\$209.00/ea.  
 HL67CLV113 (Dark Green).....\$209.00/ea.

1967-72 Valiant

2 & 4 Door Sedan - (Perforated Grain)  
 HL67CV01 (Black).....\$169.00/ea.  
 HL67CV02 (White).....\$169.00/ea.  
 1969-72 - OEM Style - (Fine Pembroke Grain)  
 HL67CV101 (Black).....\$209.00/ea.  
 HL67CV102 (White).....\$209.00/ea.

1967-69 Barracuda

Hardtop - (Perforated Grain)  
 HL67CBN01 (Black).....\$169.00/ea.  
 HL67CBN02 (White).....\$169.00/ea.  
 HL67CBN03 (Red).....\$169.00/ea.  
 HL67CBN07 (Dark Blue).....\$169.00/ea.  
 HL67CBN11 (Medium Blue).....\$169.00/ea.  
 HL67CBN13 (Dark Green).....\$169.00/ea.  
 HL67CBN17 (Buckskin).....\$169.00/ea.  
 HL67CBN31 (Maroon).....\$169.00/ea.  
 HL67CBN38 (Sandalwood).....\$169.00/ea.

1969 Hardtop - OEM Style (Fine Pembroke Grain)

HL67CBN101 (Black).....\$209.00/ea.  
 HL67CBN102 (White).....\$209.00/ea.  
 HL67CBN107 (Dark Blue).....\$209.00/ea.  
 HL67CBN110 (Bright Blue).....\$209.00/ea.  
 HL67CBN113 (Dark Green).....\$209.00/ea.

Fastback - (Perforated Grain)

HL67CBF01 (Black).....\$169.00/ea.  
 HL67CBF02 (White).....\$169.00/ea.  
 HL67CBF03 (Red).....\$169.00/ea.  
 HL67CBF07 (Dark Blue).....\$169.00/ea.  
 HL67CBF11 (Medium Blue).....\$169.00/ea.  
 HL67CBF13 (Dark Green).....\$169.00/ea.  
 HL67CBF17 (Buckskin).....\$169.00/ea.  
 HL67CBF18 (Light Blue).....\$169.00/ea.  
 HL67CBF31 (Maroon).....\$169.00/ea.  
 HL67CBF38 (Sandalwood).....\$169.00/ea.

1969 Fastback - OEM Style (Fine Pembroke Grain)

HL67CBF101 (Black).....\$209.00/ea.  
 HL67CBF102 (White).....\$209.00/ea.  
 HL67CBF107 (Dark Blue).....\$209.00/ea.  
 HL67CBF110 (Bright Blue).....\$209.00/ea.  
 HL67CBF113 (Dark Green).....\$209.00/ea.

1970-71 Duster & 1971 Demon

(Perforated Grain)  
 HL70CV01 (Black).....\$169.00/ea.  
 HL70CV02 (White).....\$169.00/ea.  
 HL70CV07 (Dark Blue).....\$169.00/ea.  
 HL70CV13 (Dark Green).....\$169.00/ea.  
 HL70CV20 (Bright Red).....\$169.00/ea.  
 HL70CV38 (Sandalwood).....\$169.00/ea.  
 HL70CV98 (Brown).....\$169.00/ea.

1970-71 Duster

1971 Demon  
 OEM Style - (Fine Pembroke Grain)  
 HL70CV101 (Black).....\$209.00/ea.  
 HL70CV102 (White).....\$209.00/ea.  
 HL70CV107 (Dark Blue).....\$209.00/ea.  
 HL70CV113 (Dark Green).....\$209.00/ea.

For 1971 Duster & Demon specify 4 or 6-bows.

1971-74 Duster

1971-72 Demon

1973-74 Dart Sport

(Perforated Grain)  
 HL71CLV01 (Black).....\$169.00/ea.  
 HL71CLV02 (White).....\$169.00/ea.  
 HL71CLV07 (Dark Blue).....\$169.00/ea.  
 HL71CLV13 (Dark Green).....\$169.00/ea.  
 HL71CLV38 (Sandalwood).....\$169.00/ea.  
 HL71CLV98 (Brown).....\$169.00/ea.

1972-74 (Non-Perforated Grain)

HL72CLV01NP (Black).....\$169.00/ea.  
 HL72CLV02NP (White).....\$169.00/ea.  
 HL72CLV07NP (Dark Blue).....\$169.00/ea.  
 HL72CLV13NP (Dark Green).....\$169.00/ea.  
 HL72CLV38NP (Sandalwood).....\$169.00/ea.

OEM Style - (Fine Pembroke Grain)

HL71CLV101 (Black).....\$209.00/ea.  
 HL71CLV102 (White).....\$209.00/ea.  
 HL71CLV107 (Dark Blue).....\$209.00/ea.  
 HL71CLV110 (Bright Blue).....\$209.00/ea.  
 HL71CLV113 (Dark Green).....\$209.00/ea.

For 1971 Duster & Demon specify 4 or 6-bows.

E-BODY MODELS

1970-71 Barracuda

5 Bow - (Perforated Grain)

HL70CB01 (Black).....\$169.00/ea.  
 HL70CB02 (White).....\$169.00/ea.  
 HL70CB13 (Dark Green).....\$169.00/ea.  
 HL70CB20 (Bright Red).....\$169.00/ea.  
 HL70CB98 (Dark Brown).....\$169.00/ea.

1970-71 Barracuda

5 Bow - (Perforated Grain)

HL70CB01 (Black).....\$169.00/ea.  
 HL70CB02 (White).....\$169.00/ea.  
 HL70CB13 (Dark Green).....\$169.00/ea.  
 HL70CB20 (Bright Red).....\$169.00/ea.  
 HL70CB98 (Dark Brown).....\$169.00/ea.

5 Bow - OEM Style - (Fine Pembroke Grain)

HL70CB101 (Black).....\$209.00/ea.  
 HL70CB102 (White).....\$209.00/ea.  
 HL70CB110 (Bright Blue).....\$209.00/ea.  
 HL70CB113 (Dark Green).....\$209.00/ea.

For 1971 Barracuda please specify 4 or 5-bows.



## HEADLINERS CONT.

### E-BODY MODELS CONT.

#### 1971-74 Barracuda

##### 4 Bow - (Perforated Grain)

HL71CB01 (Black) .....	\$169.00/ea.
HL71CB02 (White) .....	\$169.00/ea.
HL71CB13 (Dark Green) .....	\$169.00/ea.
HL71CB38 (Sandalwood) .....	\$169.00/ea.
HL71CB98 (Dark Brown) .....	\$169.00/ea.

##### 4 Bow - (Non-Perforated Grain)

HL71CB01NP (Black) .....	\$169.00/ea.
HL71CB02NP (White) .....	\$169.00/ea.
HL71CB07NP (Dark Blue) .....	\$169.00/ea.
HL71CB13NP (Dark Green) .....	\$169.00/ea.
HL71CB38NP (Sandalwood) .....	\$169.00/ea.

#### 1971-72 4 Bow - OEM Style

##### (Fine Pembroke Grain)

HL71CB101 (Black) .....	\$209.00/ea.
HL71CB102 (White) .....	\$209.00/ea.
HL71CB110 (Bright Blue) .....	\$209.00/ea.
HL71CB113 (Dark Green) .....	\$209.00/ea.

☞ For 1971 Barracuda please specify 4 or 5-bows.

#### 1970-71 Challenger

##### 5 Bow - (Perforated Grain)

HL70CJ01 (Black) .....	\$169.00/ea.
HL70CJ02 (White) .....	\$169.00/ea.
HL70CJ13 (Dark Green) .....	\$169.00/ea.
HL70CJ20 (Bright Red) .....	\$169.00/ea.
HL70CJ98 (Dark Brown) .....	\$169.00/ea.

##### 5 Bow - OEM Style - (Fine Pembroke Grain)

HL70CJ101 (Black) .....	\$209.00/ea.
HL70CJ102 (White) .....	\$209.00/ea.
HL70CJ110 (Bright Blue) .....	\$209.00/ea.
HL70CJ113 (Dark Green) .....	\$209.00/ea.
HL70CJ122 (Burnt Orange) .....	\$209.00/ea.

☞ For 1971 Challenger please specify 4 or 5-bows.

#### 1971-74 Challenger

##### 4 Bow - (Perforated Grain)

HL71CJ01 (Black) .....	\$169.00/ea.
HL71CJ02 (White) .....	\$169.00/ea.
HL71CJ13 (Dark Green) .....	\$169.00/ea.
HL71CJ38 (Sandalwood) .....	\$169.00/ea.
HL71CJ98 (Dark Brown) .....	\$169.00/ea.

##### 4 Bow - (Non-Perforated Grain)

HL71CJ01NP (Black) .....	\$169.00/ea.
HL71CJ02NP (White) .....	\$169.00/ea.
HL71CJ07NP (Dark Blue) .....	\$169.00/ea.
HL71CJ13NP (Dark Green) .....	\$169.00/ea.
HL71CJ38NP (Sandalwood) .....	\$169.00/ea.

#### 1971-72 4 Bow - OEM Style

##### (Fine Pembroke Grain)

HL71CJ101 (Black) .....	\$209.00/ea.
HL71CJ102 (White) .....	\$209.00/ea.
HL71CJ110 (Bright Blue) .....	\$209.00/ea.
HL71CJ113 (Dark Green) .....	\$209.00/ea.

☞ For 1971 Challenger please specify 4 or 5-bows.

## HEADLINER RETAINING CLIPS



Metal u-shaped retaining clips slide onto the edge of the roof-rail and help hold the headliner in place.

HLCLIP (Pkg/12) .....	\$5.00/pk.
-----------------------	------------

## HEADLINER BOW RETAINER CLIPS



Metal retainer clips slide onto the edge of the roof-rail and help secure headliner bows during installation of headliner.

HLRETAIN (Pkg/10) .....	\$39.00/pk.
-------------------------	-------------

## HEADLINER INSULATION

Headliner insulation kits glue directly to the roof and provide protection from noise, heat and cold infiltration.

#### 1964-66 A-Body (Barracuda only)

HI64CB (Fastback) .....	\$29.00/kit
-------------------------	-------------

#### 1967-69 Barracuda

HI67CB .....	\$29.00/kit
--------------	-------------

#### 1967-76 Dart

HI67CL .....	\$29.00/kit
--------------	-------------

#### 1970-76 Duster, Demon, Dart Sport

HI70CV .....	\$29.00/kit
--------------	-------------

#### 1970-74 E-Body

HI70CBJ .....	\$29.00/kit
---------------	-------------

## NOS HEADLINERS

Some colors and grains are not reproduced in today's market. We offer NOS (New Old Stock) headliners for those extremely limited items. Many years and models are available. Please call for assistance.

HLNOS .....	\$850.00/ea.
-------------	--------------

☞ Please specify year and model.

## FOAM-BACKED CLOTH HEADLINER

Replacement foam-backed headliner material for 1973 and up A-Body, 1970 Barracuda Gran Coupe and 1970 Challenger SE models with overhead consoles and cardboard style headliners. Available in a variety of colors, sample approval is highly recommended for colors other than black.

HLROLL(C) <sup>OS1</sup> .....	\$150.00/roll
--------------------------------	---------------

## ABS PLASTIC A-BODY HEADLINERS



Legendary Auto Interiors is pleased to offer new reproduction headliners for 1970-76 Dodge and Plymouth A-Body models originally equipped with a cardboard style headliner. These reproduction headliners are made from ABS plastic and are available covered with foam-back material or as a plain uncovered board. Please specify uncovered or foam-back cloth covered at time of order. Uncovered headliner boards are gray with a smooth texture, but can be painted to match interior colors. Sample approval is highly recommended for foam-back material colors other than black.

#### 1970-76 Duster <sup>OS3</sup>

HL70CV-M (Uncovered) .....	\$349.00/ea.
HL70CV-M(C) (Colors) .....	\$399.00/ea.

☞ Fit is FAIR. Please call for more details.

#### 1971-72 Demon <sup>OS3</sup>

HL70CV-M (Uncovered) .....	\$349.00/ea.
HL70CV-M(C) (Colors) .....	\$399.00/ea.

☞ Fit is FAIR. Please call for more details.

#### 1973-76 Dart Sport <sup>OS3</sup>

HL70CV-M (Uncovered) .....	\$349.00/ea.
HL70CV-M(C) (Colors) .....	\$399.00/ea.

☞ Fit is FAIR. Please call for more details.

#### 1970-76 Duster (w/ Sunroof) <sup>OS3</sup>

HL70CV-MSUN (Uncovered) .....	\$349.00/ea.
HL70CV-MSUN(C) (Colors) .....	\$399.00/ea.

☞ Fit is FAIR. Please call for more details.

#### 1971-72 Demon (w/ Sunroof) <sup>OS3</sup>

HL70CV-MSUN (Uncovered) .....	\$349.00/ea.
HL70CV-MSUN(C) (Colors) .....	\$399.00/ea.

☞ Fit is FAIR. Please call for more details.

#### 1973-76 Dart Sport <sup>OS3</sup>

HL70CV-MSUN (w/ Factory Sunroof) (Uncovered) .....	\$349.00/ea.
HL70CV-MSUN(C) (Colors) .....	\$399.00/ea.

☞ Fit is FAIR. Please call for more details.

#### 1973-76 Scamp <sup>OS3</sup>

HL73CL-M (Uncovered) .....	\$349.00/ea.
HL73CL-M(C) (Colors) .....	\$399.00/ea.

☞ Quality is FAIR. Please call for more details.

#### 1973-76 Dart Swinger <sup>OS3</sup>

##### 1973-76 Dart Swinger Special

##### 1973-76 Dart Custom

HL73CL-M (Uncovered) .....	\$349.00/ea.
HL73CL-M(C) (Colors) .....	\$399.00/ea.

☞ Quality is FAIR. Please call for more details.



### FOAM-BACK COVERED SAIL PANEL BOARDS

Die-cut to original size and shape, these reproduction sail panel boards replace warped or water damaged originals. Covered with the same foam-back materials offered on our ABS plastic headliners for a guaranteed match. Please specify uncovered, foam-back cloth or foam-back tier at time of order. Sample approval is highly recommended for foam-back material colors other than black.

- 1970-76 Duster**
- 1971-72 Demon**
- 1973-76 Dart Sport**
- SB70CVPLAIN** (Uncovered).....\$33.00/pr.
- SB70CV(C)** (Colors).....\$99.00/pr.

- 1973-76 Dart Swinger,**
- Dart Custom/Special**
- 1973-76 Scamp**
- SB67CLPLAIN** (Uncovered).....\$33.00/pr.
- SB73CL(C)** (Colors).....\$99.00/pr.

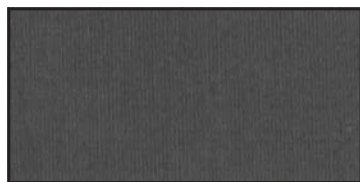
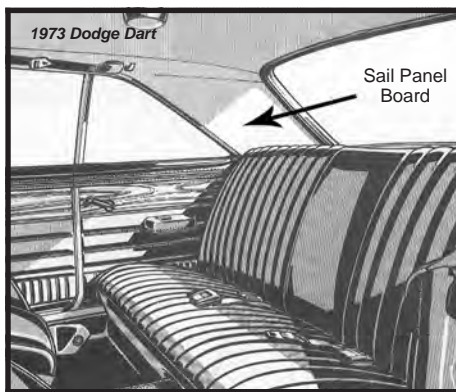

Foam-Back Cloth

(C) FOAM BACK COLOR CODES

- (01) Black
- (02) Parchment
- (07) Dark Blue
- (32) Light Gold

### SAIL PANEL BOARDS



Die-cut to original size and shape, these reproduction sail panel boards replace warped or water damaged originals. Available covered with headliner material or plain where applicable by year and model.

NOTE: Due to a special proprietary process used in-house, we guarantee the vinyl WILL NOT bubble or delaminate from the board.

#### A-BODY MODELS

- 1963-66 Dart GT**
- SB63CLPLAIN** (Plain).....\$33.00/pr.
- 1967-69 Barracuda**
- SB67CBPLAIN** (Plain).....\$33.00/pr.
- Notchback models only. NOT for fastback

- 1967-72 Dart GT**
- 1971-72 Scamp**
- SB67CLPLAIN** (67-72 Plain).....\$33.00/pr.

- 1970-72 Duster**
- SB70CVPLAIN** (Plain).....\$33.00/pr.
- (Perforated Grain)**
- SB70CV00001** (Black).....\$66.00/pr.
- SB70CV00002** (White).....\$66.00/pr.
- SB70CV00013** (Dark Green).....\$66.00/pr.
- SB70CV00020** (Bright Red).....\$66.00/pr.
- SB70CV00038** (Sandalwood).....\$66.00/pr.
- SB70CV00098** (Brown).....\$66.00/pr.
- OEM Style - (Fine Pembroke Grain)**
- SB70CV000101** (Black).....\$97.00/pr.
- SB70CV000102** (White).....\$97.00/pr.
- SB70CV000107** (Dark Blue).....\$97.00/pr.
- SB70CV000110** (Bright Blue).....\$97.00/pr.
- SB70CV000113** (Dark Green).....\$97.00/pr.

#### E-BODY MODELS

- 1970-74 Barracuda**
- SB70CBPLAIN** (Plain).....\$33.00/pr.
- (Perforated Grain)**
- SB70CB00001** (Black).....\$66.00/pr.
- SB70CB00002** (White).....\$66.00/pr.
- SB70CB00013** (Dark Green).....\$66.00/pr.
- SB70CB00020** (Bright Red).....\$66.00/pr.
- SB70CB00038** (Sandalwood).....\$66.00/pr.
- SB70CB00098** (Brown).....\$66.00/pr.
- (Non-Perforated Grain)**
- SB70CB00001NP** (Black).....\$66.00/pr.
- SB70CB00002NP** (White).....\$66.00/pr.
- SB70CB00007NP** (Dark Blue).....\$66.00/pr.
- SB70CB00013NP** (Dark Green).....\$66.00/pr.
- SB70CB00038NP** (Sandalwood).....\$66.00/pr.
- OEM Style - (Fine Pembroke Grain)**
- SB70CB000101** (Black).....\$97.00/pr.
- SB70CB000102** (White).....\$97.00/pr.
- SB70CB000110** (Bright Blue).....\$97.00/pr.
- SB70CB000113** (Dark Green).....\$97.00/pr.

- 1970-74 Challenger**
- SB70CJPLAIN** (Plain).....\$33.00/pr.



# SUNVISORS

Original reproduction sunvisors are made with the correct grains and vinyl colors as applicable by year/make/model to compliment and match your Legendary interior. Superior materials and technology with World Class craftsmanship create the highest quality sunvisors available. Original mounting hardware and metal rod must be reused. Please specify hardtop or convertible and color at time of order.

- Factory correct size, shape, colors and grains by year, make and model
- Original fit and appearance
- Custom colors and grains available
- Limited Lifetime Warranty (*First and only in the industry!!!*)
- Correct multi layer construction applicable by year, make and model
- Available with or without cut-outs for driver and passenger mirror options



***Correct multi layer construction & shape applicable by year, make, model & body style***

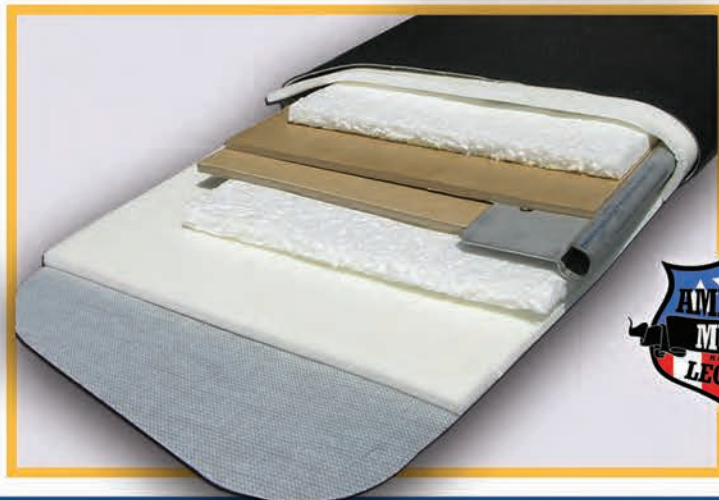



SUNVISORS

A-BODY MODELS

**1963 Dart & Valiant**

**Hardtop (Perforated Grain)**

- SV63CLV01-PA (Black).....\$168.00/pr.
- SV63CLV02-PA (White).....\$168.00/pr.
- SV63CLV11-PA (Medium Blue).....\$168.00/pr.

**Convertible (Bison Grain)**

- SV63CLV100C-PA (Black).....\$168.00/pr.
- SV63CLV206C-PA (Taupe).....\$168.00/pr.
- SV63CLV302C-PA (Blue).....\$168.00/pr.
- SV63CLV314C-PA (Metallic Blue).....\$168.00/pr.
- SV63CLV406C-PA (Light Turquoise).....\$168.00/pr.
- SV63CLV410C-PA (Light Met. Olive).....\$293.00/pr.
- SV63CLV510C-PA (Crimson Red).....\$168.00/pr.
- SV63CLV610C-PA (Metallic Fawn).....\$168.00/pr.

**1964 Barracuda**

**Hardtop (Perforated Grain)**

- SV65CBLV01-PA (Black).....\$168.00/pr.
- SV65CBLV02-PA (White).....\$168.00/pr.
- SV65CBLV11-PA (Medium Blue).....\$168.00/pr.

**1964-65 Dart & Valiant**

**Hardtop & Sedan (Perforated Grain)**

- SV65CBLV20-PA (Bright Red).....\$168.00/pr.

**Hardtop OEM Style (Crosshatch Grain)**

- SV65CBLV101-PA (Black).....\$221.00/pr.
- SV65CBLV102-PA (White).....\$221.00/pr.
- SV65CBLV111-PA (Light Metallic Blue).....\$221.00/pr.
- SV65CBLV121-PA (Metallic Red).....\$221.00/pr.

**Convertible (Bison Grain)**

- SV63CLV100C-PA (Black).....\$168.00/pr.
- SV63CLV202C-PA (Pearl White).....\$168.00/pr.
- SV63CLV314C-PA (Metallic Blue).....\$168.00/pr.
- SV63CLV520C-PA (Metallic Red).....\$168.00/pr.
- SV63CLV610C-PA (Metallic Fawn).....\$168.00/pr.
- SV63CLV614C-PA (Gold).....\$168.00/pr.

**1965 Barracuda**

**Hardtop (Perforated Grain)**

- SV65CBLV20-PA (Bright Red).....\$168.00/pr.

**Hardtop OEM Style (Crosshatch Grain)**

- SV65CBLV101-PA (Black).....\$221.00/pr.
- SV65CBLV111-PA (Light Metallic Blue).....\$221.00/pr.

**1966 Dart, Valiant & Barracuda**

**Hardtop (Cologne Grain)**

- SV66CLV100-PA (Black).....\$168.00/pr.
- SV66CLV202-PA (Pearl White).....\$168.00/pr.
- SV66CLV318-PA (Light Met. Blue).....\$168.00/pr.
- SV66CLV320-PA (Metallic Navy).....\$168.00/pr.
- SV66CLV420-PA (Citron).....\$168.00/pr.
- SV66CLV505-PA (Red).....\$168.00/pr.
- SV66CLV614-PA (Gold).....\$168.00/pr.

**Convertible (Cologne Grain)**

- SV66CLV100C-PA (Black).....\$168.00/pr.
- SV66CLV202C-PA (Pearl White).....\$168.00/pr.
- SV66CLV318C-PA (Light Met. Blue).....\$168.00/pr.
- SV66CLV505C-PA (Red).....\$168.00/pr.
- SV66CLV614C-PA (Gold).....\$168.00/pr.

**1967-68 Dart, Valiant & Barracuda**

**Hardtop (Cologne Grain)**

- SV67CBLVRWX100-PA (Black).....\$168.00/pr.
- SV67CBLVRWX202-PA (Prl. White).....\$168.00/pr.
- SV67CBLVRWX320-PA (Met Navy).....\$168.00/pr.
- SV67CBLVRWX330-PA (Met Blue).....\$168.00/pr.
- SV67CBLVRWX332-PA (Lt Met Blue).....\$168.00/pr.
- SV67CBLVRWX430-PA (Dk Met Green).....\$168.00/pr.
- SV67CBLVRWX520-PA (Met Red).....\$168.00/pr.
- SV67CBLVRWX526-PA (Met Maroon).....\$168.00/pr.
- SV67CBLVRWX618-PA (Light Gold).....\$335.00/pr.
- SV67CBLVRWX620-PA (Copper).....\$168.00/pr.
- SV67CBLVRWX622-PA (Dk Met Brown).....\$168.00/pr.
- SV67CBLVRWX634-PA (Lt Met Fawn).....\$168.00/pr.
- SV67CBLVRWX636-PA (Ember Gold).....\$168.00/pr.

**Convertible (Cologne Grain)**

- SV67CBL100C-PA (Black).....\$168.00/pr.
- SV67CBL202C-PA (Pearl White).....\$168.00/pr.
- SV67CBL320C-PA (Metallic Navy).....\$168.00/pr.
- SV67CBL332C-PA (Light Met Blue).....\$168.00/pr.
- SV67CBL430C-PA (Dark Met Green).....\$168.00/pr.
- SV67CBL520C-PA (Metallic Red).....\$168.00/pr.
- SV67CBL526C-PA (Met Maroon).....\$168.00/pr.
- SV67CBL618C-PA (Light Gold).....\$335.00/pr.
- SV67CBL620C-PA (Copper).....\$168.00/pr.
- SV67CBL636C-PA (Ember Gold).....\$168.00/pr.

**1969 Barracuda**

**Hardtop (Coachman Grain)**

- SV69CBLVRWX100-PA (Black).....\$168.00/pr.
- SV69CBLVRWX200-PA (White).....\$168.00/pr.
- SV69CBLVRWX338-PA (Bright Blue).....\$168.00/pr.
- SV69CBLVRWX434-PA (Dk Met Green).....\$168.00/pr.
- SV69CBLVRWX528-PA (Red).....\$168.00/pr.
- SV69CBLVRWX650-PA (Saddle).....\$168.00/pr.

**Convertible (Coachman Grain)**

- SV69CB100C-PA (Black).....\$168.00/pr.
- SV69CB200C-PA (White).....\$168.00/pr.
- SV69CB338C-PA (Bright Blue).....\$168.00/pr.
- SV69CB434C-PA (Dk Met Green).....\$168.00/pr.
- SV69CB528C-PA (Red).....\$168.00/pr.
- SV69CB644C-PA (Sun Gold Yellow).....\$168.00/pr.
- SV69CB650C-PA (Saddle).....\$168.00/pr.

**1969 Dart GT & Dart GTS**

**Hardtop (Dakota Grain)**

- SV69CL100-PA (Black).....\$168.00/pr.
- SV69CL202-PA (Pearl White).....\$168.00/pr.
- SV69CL332-PA (Light Met Blue).....\$168.00/pr.
- SV69CL432-PA (Light Met Green).....\$168.00/pr.
- SV69CL507-PA (Red).....\$168.00/pr.
- SV69CL630-PA (Gold).....\$168.00/pr.

**Convertible (Dakota Grain)**

- SV69CL100C-PA (Black).....\$168.00/pr.
- SV69CL202C-PA (Pearl White).....\$168.00/pr.
- SV69CL332C-PA (Light Met Blue).....\$168.00/pr.
- SV69CL432C-PA (Light Met Green).....\$168.00/pr.
- SV69CL507C-PA (Red).....\$168.00/pr.
- SV69CL630C-PA (Gold).....\$168.00/pr.

**1969 Dart Swinger & Dart Custom**

**Hardtop (Coachman Grain)**

- SV69CBLVRWX100-PA (Black).....\$168.00/pr.
- SV69CBLVRWX200-PA (White).....\$168.00/pr.
- SV69CBLVRWX330-PA (Dk Met Blue).....\$168.00/pr.
- SV69CBLVRWX434-PA (Dk Met Green).....\$168.00/pr.
- SV69CBLVRWX528-PA (Red).....\$168.00/pr.
- SV69CBLVRWX650-PA (Saddle).....\$168.00/pr.

**1970-71 Dart & Scamp**

**Hardtop (Coachman Grain)**

- SV69CBLVRWX100-PA (Black).....\$168.00/pr.
- SV69CBLVRWX200-PA (White).....\$168.00/pr.
- SV69CBLVRWX330-PA (Dk Met Blue).....\$168.00/pr.
- SV69CBLVRWX434-PA (Dk Met Green).....\$168.00/pr.
- SV69CBLVRWX452-PA (Dk Met Green).....\$168.00/pr.
- SV69CBLVRWX656-PA (Brown).....\$168.00/pr.
- SV69CBLVRWX666-PA (Ember Gold).....\$168.00/pr.

**1970 Duster**

**(Coachman Grain)**

- SV70CV100-PA (Black).....\$168.00/pr.
- SV70CV200-PA (White).....\$168.00/pr.
- SV70CV330-PA (Dark Met Blue).....\$168.00/pr.
- SV70CV434-PA (Dark Met Green).....\$168.00/pr.
- SV70CV550-PA (Red).....\$168.00/pr.
- SV70CV656-PA (Brown).....\$168.00/pr.

**1971 Duster & Demon**

**(Coachman Grain)**

- SV71CV100-PA (Black).....\$168.00/pr.
- SV71CV330-PA (Dark Met Blue).....\$168.00/pr.
- SV71CV452-PA (Dark Met Green).....\$168.00/pr.
- SV71CV664-PA (Brown).....\$168.00/pr.
- SV71CV666-PA (Ember Gold).....\$168.00/pr.

**1972 Duster & Demon**

**(Coachman Grain)**

- SV72CV100-PA (Black).....\$168.00/pr.
- SV72CV200-PA (White).....\$168.00/pr.
- SV72CV340-PA (Bright Blue).....\$168.00/pr.
- SV72CV444-PA (Dark Green).....\$168.00/pr.
- SV72CV666-PA (Ember Gold).....\$168.00/pr.

**1972-73 Dart & Scamp**

**(Coachman Grain)**

- SV72CL100-PA (Black).....\$168.00/pr.
- SV72CL250-PA (Parchment).....\$168.00/pr.
- SV72CL340-PA (Bright Blue).....\$168.00/pr.
- SV72CL444-PA (Dark Green).....\$168.00/pr.
- SV72CL666-PA (Ember Gold).....\$168.00/pr.
- SV72CL672-PA (NOS Honey Gold).....\$335.00/pr.

## SUNVISORS CONT.

### A-BODY MODELS CONT.

#### 1973 Duster & Dart Sport (Coachman Grain)

SV73CV100-PA (Black).....	\$168.00/pr.
SV73CV200-PA (White).....	\$168.00/pr.
SV73CV250-PA (Parchment).....	\$168.00/pr.
SV73CV340-PA (Bright Blue).....	\$168.00/pr.
SV73CV444-PA (Dark Green).....	\$168.00/pr.
SV73CV671-PA (Honey Gold).....	\$168.00/pr.
SV73CV672-PA (NOS Honey Gold).....	\$168.00/pr.

#### 1974-76 Duster & Dart Sport (Oxford Grain)

SV74CV100-PA (Black).....	\$168.00/pr.
SV74CV200-PA (White).....	\$168.00/pr.
SV74CV264-PA (Parchment).....	\$308.00/pr.
SV74CV360-PA (Lagoon Blue).....	\$168.00/pr.
SV74CV450-PA (Jade Green).....	\$168.00/pr.
SV74CV453-PA (Light Met Green).....	\$335.00/pr.
SV74CV680-PA (Ember Gold).....	\$335.00/pr.

#### 1974-76 Dart & Scamp (Oxford Grain)

SV74CL100-PA (Black).....	\$168.00/pr.
SV74CL264-PA (White).....	\$308.00/pr.
SV74CL360-PA (Lagoon Blue).....	\$168.00/pr.
SV74CL450-PA (Jade Green).....	\$168.00/pr.
SV74CL453-PA (Light Met Green).....	\$335.00/pr.
SV74CL680-PA (Ember Gold).....	\$335.00/pr.

### E-BODY MODELS

#### 1970-71 Barracuda & Challenger Hardtop (Coachman Grain)

SV70CBJ100-PA (Black).....	\$168.00/pr.
SV70CBJ200-PA (White).....	\$168.00/pr.
SV70CBJ338-PA (Bright Blue).....	\$168.00/pr.
SV70CBJ340-PA (Bright Blue).....	\$168.00/pr.
SV70CBJ434-PA (Dark Met Green)....	\$168.00/pr.
SV70CBJ452-PA (Dark Met Green)....	\$168.00/pr.
SV70CBJ540-PA (Burnt Orange).....	\$168.00/pr.
SV70CBJ550-PA (Red).....	\$168.00/pr.
SV70CBJ656-PA (Brown).....	\$168.00/pr.
SV70CBJ664-PA (Brown).....	\$168.00/pr.
SV70CBJ666-PA (Ember Gold).....	\$168.00/pr.

#### Convertible (Coachman Grain)

SV70CBJ100C-PA (Black).....	\$168.00/pr.
SV70CBJ200C-PA (White).....	\$168.00/pr.
SV70CBJ338C-PA (Bright Blue).....	\$168.00/pr.
SV70CBJ340C-PA (Bright Blue).....	\$168.00/pr.
SV70CBJ434C-PA (Dark Met Green).....	\$168.00/pr.
SV70CBJ452C-PA (Dark Met Green).....	\$168.00/pr.
SV70CBJ540C-PA (Burnt Orange).....	\$168.00/pr.
SV70CBJ550C-PA (Red).....	\$168.00/pr.
SV70CBJ656C-PA (Brown).....	\$168.00/pr.
SV70CBJ664C-PA (Brown).....	\$168.00/pr.
SV70CBJ666C-PA (Ember Gold).....	\$168.00/pr.

### E-BODY MODELS CONT.

#### 1972-73 Barracuda & Challenger (Coachman Grain)

SV72CBJ100-PA (Black).....	\$168.00/pr.
SV72CBJ200-PA (White).....	\$168.00/pr.
SV72CBJ340-PA (Bright Blue).....	\$168.00/pr.
SV72CBJ444-PA (Dark Green).....	\$168.00/pr.
SV72CBJ666-PA (Ember Gold).....	\$168.00/pr.

#### 1974 Barracuda & Challenger (Oxford Grain)

SV74CBJ100-PA (Black).....	\$168.00/pr.
SV74CBJ200-PA (White).....	\$168.00/pr.
SV74CBJ360-PA (Lagoon Blue).....	\$168.00/pr.
SV74CBJ450-PA (Jade Green).....	\$168.00/pr.

### DODGE TRUCK

#### 1978 Lil Red Express & Warlock (Oxford Grain)

SV78CDT0000100 (Black).....	\$168.00/pr.
SV78CDT0000548 (Red).....	\$168.00/pr.

#### 1979 Lil Red Express & Warlock (Oxford Grain)

SV79CDT0000100 (Black).....	\$168.00/pr.
SV79CDT0000548 (Red).....	\$168.00/pr.

## FOAM-BACK COVERED SUNVISORS

Original reproduction sunvisors covered with the same foam-back materials offered on our ABS plastic headliners for a guaranteed match. Original mounting hardware must be reused. Please specify foam-back cloth or foam-back tier at time of order. Sample recommended for foam-back material colors other than black.

#### 1970-76 Duster 1971-72 Demon 1973-76 Dart Sport

SV70CV(C) (Colors).....	\$160.00/pr.
-------------------------	--------------

#### 1973-76 Dart Swinger, Dart Custom/ Special

#### 1973-76 Dart Custom, Dart Special

#### 1973-76 Scamp

SV73CL(C) (Colors).....	\$160.00/pr.
-------------------------	--------------

## PLASTIC SUNVISOR TIPS



Reproduction 1962-65 Dodge & Plymouth sunvisor tips made of Delrin plastic.

SV62TIP.....	\$29.00/pr.
--------------	-------------

## RUBBER SUNVISOR TIPS





Dodge & Plymouth rubber sunvisor tips for 1966 and up models with 2-pin sunvisors and a center mounted sunvisor retainer over the rearview mirror.

SVTIP-RUBBER.....	\$3.00/pr.
-------------------	------------





# PACKAGE TRAY AND TRUNK ACCESORIES

 [facebook.com/legendaryautointeriors](https://facebook.com/legendaryautointeriors)  
 [twitter.com/legendaryautoin](https://twitter.com/legendaryautoin)

 [www.legendaryautointeriors.com](https://www.legendaryautointeriors.com)  
 [instagram.com/legendaryautointeriorsltd](https://instagram.com/legendaryautointeriorsltd)  
 [youtube.com/user/legendaryauto](https://youtube.com/user/legendaryauto)

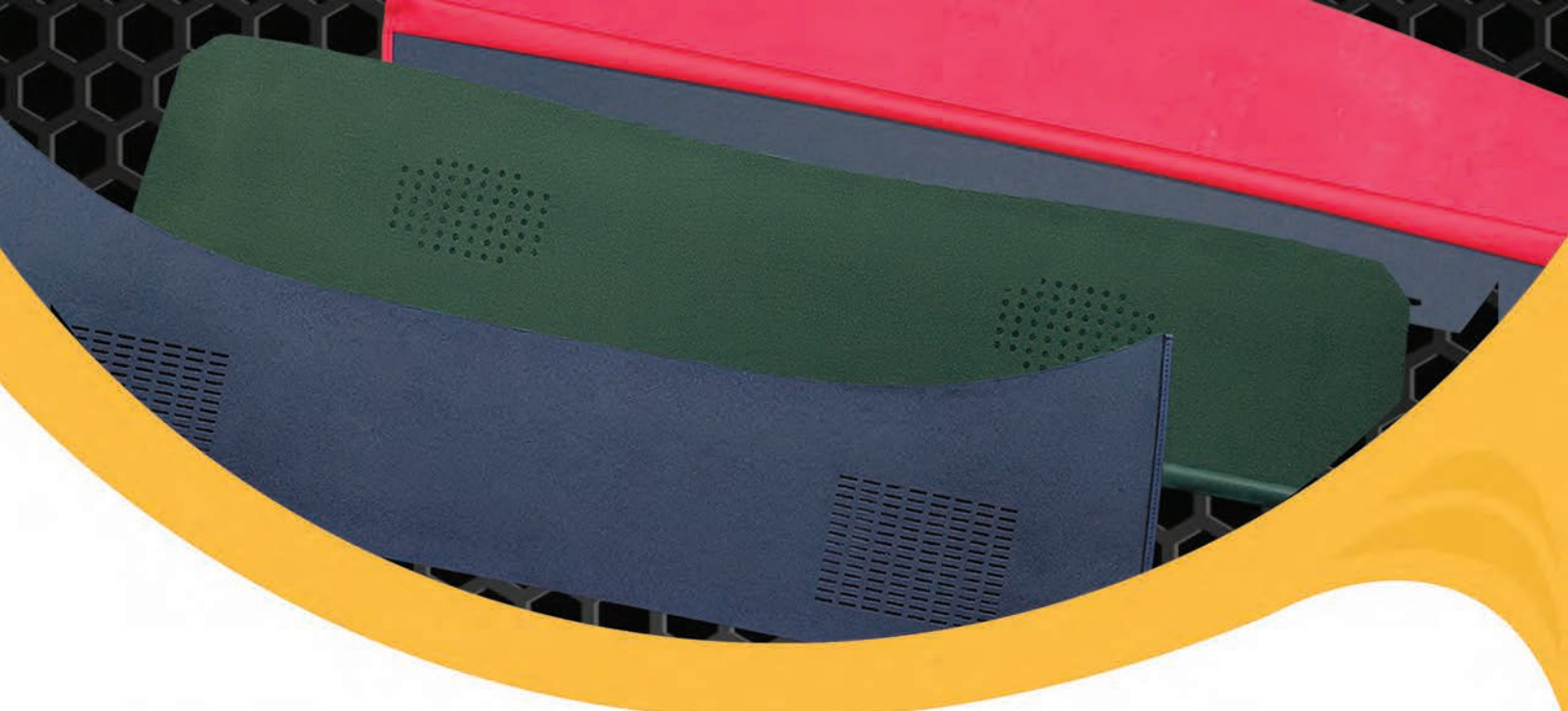

# PACKAGE TRAYS AND JUTE INSULATION

Die-cut to original specifications, these reproductions of the original panels go between the top of the rear seat and the back window. Colors are year specific and are available with or without speaker grill cutouts. Die-cut jute insulation helps reduce the amount of noise and heat that would come from the trunk compartment.

## E-BODY MODELS

### **1970-74 Barracuda**

#### **Hardtop w/o Cuts**

PT70CB100N (Black).....	\$79.00/ea.
PT70CB338N (Bright Blue).....	\$79.00/ea.
PT70CB340N (Bright Blue).....	\$79.00/ea.
PT70CB360N (Lagoon Blue).....	\$79.00/ea.
PT70CB434N (Dark Metallic Green).....	\$79.00/ea.
PT70CB444N (Dark Green).....	\$79.00/ea.
PT70CB450N (Jade Green).....	\$79.00/ea.
PT70CB452N (Dark Metallic Green).....	\$79.00/ea.
PT70CB540N (Burnt Orange).....	\$79.00/ea.
PT70CB550N (Red).....	\$79.00/ea.
PT70CB656N (Brown).....	\$79.00/ea.
PT70CB664N (Brown).....	\$79.00/ea.
PT70CB666N (Ember Gold).....	\$79.00/ea.

#### **Hardtop w/ Cuts**

PT70CB100 (Black).....	\$119.00/ea.
PT70CB338 (Bright Blue).....	\$119.00/ea.
PT70CB340 (Bright Blue).....	\$119.00/ea.
PT70CB360 (Lagoon Blue).....	\$119.00/ea.
PT70CB434 (Dark Metallic Green).....	\$119.00/ea.
PT70CB444 (Dark Green).....	\$119.00/ea.
PT70CB450 (Jade Green).....	\$119.00/ea.
PT70CB452 (Dark Metallic Green).....	\$119.00/ea.
PT70CB540 (Burnt Orange).....	\$119.00/ea.
PT70CB550 (Red).....	\$119.00/ea.
PT70CB656 (Brown).....	\$119.00/ea.
PT70CB664 (Brown).....	\$119.00/ea.
PT70CB666 (Ember Gold).....	\$119.00/ea.
PT70CBJ (jute insulation).....	\$27.00/ea.

### **1970-74 Challenger**

#### **Hardtop w/o Cuts**

PT70CJ100N (Black).....	\$79.00/ea.
PT70CJ338N (Bright Blue).....	\$79.00/ea.
PT70CJ340N (Bright Blue).....	\$79.00/ea.
PT70CJ360N (Lagoon Blue).....	\$79.00/ea.
PT70CJ434N (Dark Metallic Green).....	\$79.00/ea.
PT70CJ444N (Dark Green).....	\$79.00/ea.
PT70CJ450N (Jade Green).....	\$79.00/ea.
PT70CJ452N (Dark Metallic Green).....	\$79.00/ea.
PT70CJ540N (Burnt Orange).....	\$79.00/ea.
PT70CJ550N (Red).....	\$79.00/ea.
PT70CJ656N (Brown).....	\$79.00/ea.
PT70CJ664N (Brown).....	\$79.00/ea.
PT70CJ666N (Ember Gold).....	\$79.00/ea.

#### **Hardtop w/ Cuts**

PT70CJ100 (Black).....	\$119.00/ea.
PT70CJ338 (Bright Blue).....	\$119.00/ea.
PT70CJ340 (Bright Blue).....	\$119.00/ea.
PT70CJ360 (Lagoon Blue).....	\$119.00/ea.
PT70CJ434 (Dark Metallic Green).....	\$119.00/ea.
PT70CJ444 (Dark Green).....	\$119.00/ea.
PT70CJ450 (Jade Green).....	\$119.00/ea.
PT70CJ452 (Dark Metallic Green).....	\$119.00/ea.
PT70CJ540 (Burnt Orange).....	\$119.00/ea.
PT70CJ550 (Red).....	\$119.00/ea.
PT70CJ656 (Brown).....	\$119.00/ea.
PT70CJ664 (Brown).....	\$119.00/ea.
PT70CJ666 (Ember Gold).....	\$119.00/ea.
PT70CJJ (jute insulation).....	\$27.00/ea.

PACKAGE TRAYS & JUTE INSULATION

A-BODY MODELS

**1962 Valiant**   
Hardtop w/o Cuts

- PT62CV100N (Black) ..... \$79.00/ea.
- PT62CVJ (jute insulation)..... \$27.00/ea.

**1963-65 Valiant**   
Hardtop w/o Cuts

- PT63CVH100N (Black)..... \$79.00/ea.
- PT63CVH206N (Taupe) ..... \$79.00/ea.
- PT63CVH302N (Blue)..... \$79.00/ea.
- PT63CVH314N (Metallic Blue)..... \$79.00/ea.
- PT63CVH510N (Crimson Red) ..... \$79.00/ea.
- PT63CVH610N (Metallic Fawn) ..... \$79.00/ea.
- PT63CVH614N (Gold)..... \$79.00/ea.

Hardtop w/ Cuts

- PT63CVH100 (Black)..... \$119.00/ea.
- PT63CVH206 (Taupe)..... \$119.00/ea.
- PT63CVH302 (Blue)..... \$119.00/ea.
- PT63CVH314 (Metallic Blue)..... \$119.00/ea.
- PT63CVH510 (Crimson Red)..... \$119.00/ea.
- PT63CVH610 (Metallic Fawn)..... \$119.00/ea.
- PT63CVH614 (Gold)..... \$119.00/ea.
- PT63CVHJ (Hardtop jute insulation) ..... \$27.00/ea.

Sedan w/o Cuts

- PT63CVS302N (Blue)..... \$79.00/ea.
- PT63CVS314N (Metallic Blue) ..... \$79.00/ea.
- PT63CVS510N (Crimson Red)..... \$79.00/ea.
- PT63CVS610N (Metallic Fawn)..... \$79.00/ea.
- PT63CVSJ (Sedan jute insulation)..... \$27.00/ea.

Will not work for Signet models.

**1963 Dart & Dart GT**   
Hardtop w/o Cuts

- PT63CL206N (Taupe)..... \$79.00/ea.
- PT63CL302N (Blue)..... \$79.00/ea.
- PT63CL406N (Light Turquoise)..... \$79.00/ea.
- PT63CL418N (Dark Green)..... \$79.00/ea.
- PT63CL510N (Crimson Red)..... \$79.00/ea.

Hardtop w/ Cuts

- PT63CL206(C) (Taupe)..... \$119.00/ea.
- PT63CL302(C) (Blue)..... \$119.00/ea.
- PT63CL406(C) (Light Turquoise) ..... \$119.00/ea.
- PT63CL418(C) (Dark Green)..... \$119.00/ea.
- PT63CL510(C) (Crimson Red)..... \$119.00/ea.
- PT63CLJ (Hardtop jute insulation)..... \$27.00/ea.

**1963-65 Valiant Signet**   
Hardtop w/o Cuts

- PT63CVH100N (Black)..... \$79.00/ea.
- PT63CVH206N (Taupe) ..... \$79.00/ea.
- PT63CVH302N (Blue)..... \$79.00/ea.
- PT63CVH314N (Metallic Blue)..... \$79.00/ea.
- PT63CVH510N (Crimson Red) ..... \$79.00/ea.
- PT63CVH610N (Metallic Fawn) ..... \$79.00/ea.
- PT63CVH614N (Gold)..... \$79.00/ea.

Hardtop w/ Cuts

- PT63CVH100 (Black)..... \$119.00/ea.
- PT63CVH206 (Taupe)..... \$119.00/ea.
- PT63CVH302 (Blue)..... \$119.00/ea.
- PT63CVH314 (Metallic Blue)..... \$119.00/ea.
- PT63CVH510 (Crimson Red)..... \$119.00/ea.
- PT63CVH610 (Metallic Fawn)..... \$119.00/ea.
- PT63CVH614 (Gold)..... \$119.00/ea.
- PT63CVJ (jute insulation)..... \$27.00/ea.

**1964 Dart**   
4 Door Sedan w/o Cuts

- PT64CL4D01N (Black)..... \$79.00/ea.
- PT64CL4J (jute insulation)..... \$27.00/ea.

**1964 Dart & Dart GT**   
Hardtop w/o Cuts

- PT64CL100N (Black)..... \$79.00/ea.
- PT64CL314N (Metallic Blue)..... \$79.00/ea.
- PT64CL410N (Light Metallic Olive)..... \$79.00/ea.
- PT64CL510N (Crimson Red)..... \$79.00/ea.
- PT64CL610N (Metallic Fawn) ..... \$79.00/ea.

Hardtop w/ Cuts

- PT64CL100 (Black)..... \$119.00/ea.
- PT64CL314 (Metallic Blue) ..... \$119.00/ea.
- PT64CL410 (Light Metallic Olive)..... \$119.00/ea.
- PT64CL510 (Crimson Red)..... \$119.00/ea.
- PT64CL610 (Metallic Fawn)..... \$119.00/ea.
- PT64CLJ (jute insulation)..... \$27.00/ea.

**1965-66 Dart & Dart GT**   
Hardtop w/o Cuts

- PT65CL100N (Black)..... \$79.00/ea.
- PT65CL314N (Metallic Blue)..... \$79.00/ea.
- PT65CL318N (Light Metallic Blue)..... \$79.00/ea.
- PT65CL505N (Red)..... \$79.00/ea.
- PT65CL520N (Metallic Red)..... \$79.00/ea.
- PT65CL610N (Metallic Fawn) ..... \$79.00/ea.
- PT65CL614N (Gold)..... \$79.00/ea.

Hardtop w/ Cuts

- PT65CL100 (Black)..... \$119.00/ea.
- PT65CL314 (Metallic Blue) ..... \$119.00/ea.
- PT65CL318 (Light Metallic Blue)..... \$119.00/ea.
- PT65CL505 (Red)..... \$119.00/ea.
- PT65CL520 (Metallic Red)..... \$119.00/ea.
- PT65CL610 (Metallic Fawn)..... \$119.00/ea.
- PT65CL614 (Gold)..... \$119.00/ea.
- PT65CLJ (jute insulation)..... \$27.00/ea.

**1966 Valiant**   
Hardtop w/o Cuts

- PT66CV100N (Black)..... \$79.00/ea.
- PT66CV318N (Light Metallic Blue)..... \$79.00/ea.
- PT66CV505N (Red)..... \$79.00/ea.
- PT66CV614N (Gold)..... \$79.00/ea.
- PT66CVJ (jute insulation)..... \$27.00/ea.

**1967-69 Barracuda**   
Hardtop w/o Cuts

- PT67CB100N (Black)..... \$79.00/ea.
- PT67CB320N (Metallic Navy)..... \$79.00/ea.
- PT67CB332N (Light Metallic Blue)..... \$79.00/ea.
- PT67CB338N (Brite Blue)..... \$79.00/ea.
- PT67CB430N (Dark Metallic Green)..... \$79.00/ea.
- PT67CB434N (Dark Metallic Green)..... \$79.00/ea.
- PT67CB520N (Metallic Red)..... \$79.00/ea.
- PT67CB526N (Metallic Maroon) ..... \$79.00/ea.
- PT67CB528N (Red)..... \$79.00/ea.
- PT67CB618N (Light Gold)..... \$79.00/ea.
- PT67CB620N (Copper)..... \$79.00/ea.
- PT67CB636N (Ember Gold)..... \$79.00/ea.
- PT67CB650N (Saddle)..... \$79.00/ea.

Hardtop w/ Cuts

- PT67CB100 (Black)..... \$119.00/ea.
- PT67CB320 (Metallic Navy)..... \$119.00/ea.
- PT67CB332 (Light Metallic Blue)..... \$119.00/ea.
- PT67CB338 (Brite Blue)..... \$119.00/ea.
- PT67CB430 (Dark Metallic Green)..... \$119.00/ea.
- PT67CB434 (Dark Metallic Green)..... \$119.00/ea.
- PT67CB520 (Metallic Red)..... \$119.00/ea.
- PT67CB526 (Metallic Maroon)..... \$119.00/ea.
- PT67CB528 (Red)..... \$119.00/ea.
- PT67CB618 (Light Gold)..... \$119.00/ea.
- PT67CB620 (Copper)..... \$119.00/ea.
- PT67CB636 (Ember Gold)..... \$119.00/ea.
- PT67CB650 (Saddle)..... \$119.00/ea.
- PT67CBJ (jute insulation)..... \$27.00/ea.

**1967-69 Valiant**   
Sedan w/o Cuts

- PT67CV100N (Black)..... \$79.00/ea.
- PT67CV320N (Metallic Navy)..... \$79.00/ea.
- PT67CV330N (Dark Metallic Blue)..... \$79.00/ea.
- PT67CV414N (Dark Met. Turquoise)..... \$79.00/ea.
- PT67CV520N (Metallic Red)..... \$79.00/ea.
- PT67CV622N (Dark Metallic Brown)..... \$79.00/ea.
- PT67CV632N (Dark Metallic Fawn) ..... \$79.00/ea.
- PT67CV650N (Saddle)..... \$79.00/ea.

Sedan w/ Cuts

- PT67CV100 (Black)..... \$119.00/ea.
- PT67CV320 (Metallic Navy) ..... \$119.00/ea.
- PT67CV330 (Dark Metallic Blue)..... \$119.00/ea.
- PT67CV414 (Dark Metallic Turquoise)..... \$119.00/ea.
- PT67CV520 (Metallic Red)..... \$119.00/ea.
- PT67CV622 (Dark Metallic Brown)..... \$119.00/ea.
- PT67CV632 (Dark Metallic Fawn)..... \$119.00/ea.
- PT67CV650 (Saddle)..... \$119.00/ea.
- PT67CVJ (jute insulation)..... \$27.00/ea.

**1967-69 Dart & Dart GT**   
Hardtop w/o Cuts

- PT67CL100N (Black)..... \$79.00/ea.
- PT67CL318N (Light Metallic Blue)..... \$79.00/ea.
- PT67CL320N (Metallic Navy)..... \$79.00/ea.
- PT67CL330N (Dark Metallic Blue)..... \$79.00/ea.
- PT67CL332N (Light Metallic Blue)..... \$79.00/ea.
- PT67CL340N (Bright Blue)..... \$79.00/ea.
- PT67CL430N (Dark Metallic Green) ..... \$79.00/ea.
- PT67CL432N (Light Metallic Green) ..... \$79.00/ea.
- PT67CL434N (Dark Metallic Green) ..... \$79.00/ea.
- PT67CL444N (Dark Green)..... \$79.00/ea.
- PT67CL507N (Red)..... \$79.00/ea.
- PT67CL520N (Metallic Red) ..... \$79.00/ea.
- PT67CL528N (Red)..... \$79.00/ea.
- PT67CL618N (Light Gold)..... \$79.00/ea.
- PT67CL620N (Copper)..... \$79.00/ea.
- PT67CL630N (Gold)..... \$79.00/ea.
- PT67CL632N (Dark Metallic Fawn)..... \$79.00/ea.
- PT67CL636N (Ember Gold)..... \$79.00/ea.
- PT67CL650N (Saddle)..... \$79.00/ea.

Hardtop w/ Cuts

- PT67CL100 (Black)..... \$119.00/ea.
- PT67CL318 (Light Metallic Blue)..... \$119.00/ea.
- PT67CL320 (Metallic Navy) ..... \$119.00/ea.
- PT67CL330 (Dark Metallic Blue)..... \$119.00/ea.
- PT67CL332 (Light Metallic Blue)..... \$119.00/ea.
- PT67CL340 (Bright Blue)..... \$119.00/ea.
- PT67CL430 (Dark Metallic Green)..... \$119.00/ea.
- PT67CL432 (Light Metallic Green)..... \$119.00/ea.
- PT67CL434 (Dark Metallic Green)..... \$119.00/ea.
- PT67CL444 (Dark Green)..... \$119.00/ea.
- PT67CL507 (Red)..... \$119.00/ea.
- PT67CL520 (Metallic Red)..... \$119.00/ea.
- PT67CL528 (Red)..... \$119.00/ea.
- PT67CL618 (Light Gold)..... \$119.00/ea.
- PT67CL620 (Copper)..... \$119.00/ea.
- PT67CL630 (Gold)..... \$119.00/ea.
- PT67CL632 (Dark Metallic Fawn)..... \$119.00/ea.
- PT67CL636 (Ember Gold)..... \$119.00/ea.
- PT67CLJ (jute insulation)..... \$27.00/ea.

## PACKAGE TRAYS & JUTE INSULATION CONT.

### A-BODY MODELS CONT.

#### 1970-74 Dart & Dart GT

##### Hardtop w/o Cuts

PT70CL100N (Black) .....	\$79.00/ea.
PT70CL330N (Dark Metallic Blue) .....	\$79.00/ea.
PT70CL340N (Bright Blue) .....	\$79.00/ea.
PT70CL360N (Lagoon Blue) .....	\$79.00/ea.
PT70CL434N (Dark Metallic Green) .....	\$79.00/ea.
PT70CL444N (Dark Green) .....	\$79.00/ea.
PT70CL450N (Jade Green) .....	\$79.00/ea.
PT70CL452N (Dark Metallic Green) .....	\$79.00/ea.
PT70CL656N (Brown) .....	\$79.00/ea.
PT70CL666N (Ember Gold) .....	\$79.00/ea.
PT70CL672N (NOSHoney Gold) .....	\$79.00/ea.
PT70CL680N (Ember Gold) .....	\$79.00/ea.

##### Hardtop w/ Cuts

PT70CL100 (Black) .....	\$119.00/ea.
PT70CL330 (Dark Metallic Blue) .....	\$119.00/ea.
PT70CL340 (Bright Blue) .....	\$119.00/ea.
PT70CL360 (Lagoon Blue) .....	\$119.00/ea.
PT70CL434 (Dark Metallic Green) .....	\$119.00/ea.
PT70CL444 (Dark Green) .....	\$119.00/ea.
PT70CL450 (Jade Green) .....	\$119.00/ea.
PT70CL452 (Dark Metallic Green) .....	\$119.00/ea.
PT70CL656 (Brown) .....	\$119.00/ea.
PT70CL666 (Ember Gold) .....	\$119.00/ea.
PT70CL672 (NOS Honey Gold) .....	\$119.00/ea.
PT70CL680 (Ember Gold) .....	\$119.00/ea.
PT70CLVJ (jute insulation) .....	\$27.00/ea.

#### 1970-72 Duster & Demon

##### Fastback w/o Cuts

PT70CLV100N (Black) .....	\$79.00/ea.
PT70CLV330N (Dark Metallic Blue) .....	\$79.00/ea.
PT70CLV434N (Dark Metallic Green) .....	\$79.00/ea.
PT70CLV444N (Dark Green) .....	\$79.00/ea.
PT70CLV452N (Dark Metallic Green) .....	\$79.00/ea.
PT70CLV550N (Red) .....	\$79.00/ea.
PT70CLV656N (Brown) .....	\$79.00/ea.
PT70CLV664N (Brown) .....	\$79.00/ea.
PT70CLV666N (Ember Gold) .....	\$79.00/ea.

##### Fastback w/ Cuts

PT70CLV100 (Black) .....	\$119.00/ea.
PT70CLV330 (Dark Metallic Blue) .....	\$119.00/ea.
PT70CLV434 (Dark Metallic Green) .....	\$119.00/ea.
PT70CLV444 (Dark Metallic Green) .....	\$119.00/ea.
PT70CLV452 (Dark Metallic Green) .....	\$119.00/ea.
PT70CLV550 (Red) .....	\$119.00/ea.
PT70CLV656 (Brown) .....	\$119.00/ea.
PT70CLV664 (Brown) .....	\$119.00/ea.
PT70CLV666 (Ember Gold) .....	\$119.00/ea.
PT70CLVJ (jute insulation) .....	\$27.00/ea.

#### 1973-76 Duster & Dart Sport

##### Fastback w/o Cuts

PT73CLV100N (Black) .....	\$79.00/ea.
PT73CLV340N (Bright Blue) .....	\$79.00/ea.
PT73CLV360N (Lagoon Blue) .....	\$79.00/ea.
PT73CLV444N (Dark Green) .....	\$79.00/ea.
PT73CLV450N (Jade Green) .....	\$79.00/ea.
PT73CLV453N (Light Metallic Green) .....	\$79.00/ea.
PT73CLV680N (NOS Ember Gold) .....	\$79.00/ea.

#### 1973-76 Duster & Dart Sport

##### Fastback w/ Cuts

PT73CLV100 (Black) .....	\$119.00/ea.
PT73CLV340 (Bright Blue) .....	\$119.00/ea.
PT73CLV360 (Lagoon Blue) .....	\$119.00/ea.
PT73CLV444 (Dark Green) .....	\$119.00/ea.
PT73CLV450 (Jade Green) .....	\$119.00/ea.
PT73CLV453 (Light Metallic Green) .....	\$119.00/ea.
PT73CLV680 (Ember Gold) .....	\$119.00/ea.
PT73CLVJ (jute insulation) .....	\$27.00/ea.

#### 1973-74 Duster & Dart Sport (w/ fold-down rear)

##### Fastback w/o Cuts

PT73CLVFD100N (Black) .....	\$79.00/ea.
PT73CLVFD340N (Bright Blue) .....	\$79.00/ea.
PT73CLVFD360N (Lagoon Blue) .....	\$79.00/ea.
PT73CLVFD444N (Dark Green) .....	\$79.00/ea.
PT73CLVFD450N (Jade Green) .....	\$79.00/ea.
PT73CLVFD680N (Ember Gold) .....	\$700.00/ea.

##### Fastback w/ Cuts

PT73CLVFD100 (Black) .....	\$119.00/ea.
PT73CLVFD340 (Bright Blue) .....	\$119.00/ea.
PT73CLVFD360 (Lagoon Blue) .....	\$119.00/ea.
PT73CLVFD444 (Dark Green) .....	\$119.00/ea.
PT73CLVFD450 (Jade Green) .....	\$119.00/ea.
PT73CLVFD680  (NOS Ember Gold) .....	\$119.00/ea.

#### 1975-76 Dart

##### Hardtop w/o Cuts

PT75CL100N (Black) .....	\$79.00/ea.
PT75CL360N (Lagoon Blue) .....	\$79.00/ea.
PT75CL450N (Jade Green) .....	\$79.00/ea.
PT75CL453N (Light Metallic Green) .....	\$79.00/ea.
PT75CL680N (Ember Gold) .....	\$79.00/ea.

##### Hardtop w/ Cuts

PT75CL100 (Black) .....	\$119.00/ea.
PT75CL360 (Lagoon Blue) .....	\$119.00/ea.
PT75CL450 (Jade Green) .....	\$119.00/ea.
PT75CL453 (Light Metallic Green) .....	\$119.00/ea.
PT75CL680 (NOS Ember Gold) .....	\$119.00/ea.
PT75CLJ (jute insulation) .....	\$27.00/ea.





# TRUNK MATS

Original style rubber trunk mats die-cut to factory specifications to assure a correct fit. Please specify material pattern at time of order.

## A-BODY MODELS

### **1963-66 Dart & Dart GT**

TM63CLGP (Hardtop).....	\$89.00/ea.
TM63CLHT (Hardtop).....	\$89.00/ea.
TM63CLTP (Hardtop).....	\$89.00/ea.
TM63CLGPC (Convertible).....	\$89.00/ea.
TM63CLHTC (Convertible).....	\$89.00/ea.

### **1963-66 Valiant**

TM63CVGP (Hardtop).....	\$89.00/ea.
TM63CVHT (Hardtop).....	\$89.00/ea.

### **1967-69 Dart & Dart GT**

TM67CLGP (Hardtop).....	\$89.00/ea.
TM67CLHT (Hardtop).....	\$89.00/ea.
TM67CLTP (Hardtop).....	\$89.00/ea.
TM67CLGPC (Convertible).....	\$89.00/ea.
TM67CLHTC (Convertible).....	\$89.00/ea.
TM67CLTPC (Convertible).....	\$89.00/ea.

### **1967-69 Barracuda**

TM67CBGP (Hardtop & Convertible) ..	\$89.00/ea.
TM67CBHT (Hardtop & Convertible) ..	\$89.00/ea.
TM67CBTP (Hardtop & Convertible) ..	\$89.00/ea.
TM67CBGPF (Fastback).....	\$89.00/ea.
TM67CBHTF (Fastback).....	\$89.00/ea.
TM67CBTPF (Fastback).....	\$89.00/ea.

### **1970-73 Dart**

TM70CLGP (Hardtop).....	\$89.00/ea.
TM70CLHB (Hardtop).....	\$89.00/ea.
TM70CLHT (Hardtop).....	\$89.00/ea.

### **1970-76 Duster**

### **1971-72 Demon**

### **1973-76 Dart Sport**

TM70CLVGP (Fastback).....	\$89.00/ea.
TM70CLVHB (Fastback).....	\$89.00/ea.
TM70CLVHT (Fastback).....	\$89.00/ea.

### **1974-76 Dart**

TM74CLGP.....	\$89.00/ea.
TM74CLHB.....	\$89.00/ea.
TM74CLHT.....	\$89.00/ea.

**CONTINUED ON NEXT PAGE**



Houndstooth

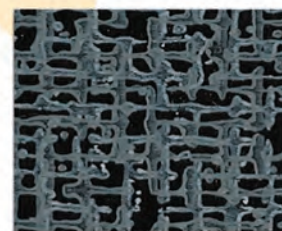

Herringbone

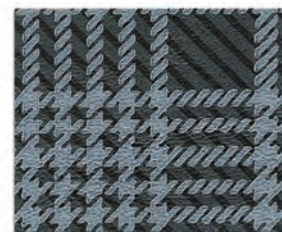

Gray Plaid

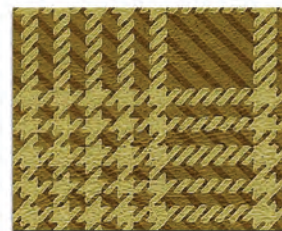

Tan Plaid

# Chrysler, Dodge, Plymouth

## TRUNK MATS

### E-BODY MODELS

#### 1970-74 Barracuda

**TM70CBHB** (Hardtop & Convertible) .. \$89.00/ea.  
 Ⓞ 1970-74 models used Herringbone only.

#### 1970-74 Challenger

**TM70CJHB** (Hardtop & Convertible).. \$89.00/ea.  
 Ⓞ 1970-74 models used Herringbone only.

### 1963-65 PLYMOUTH BELVEDERE MOLDED TRUNK MATS

Pre-molded trunk mats for 1963-65 Belvedere models. Available in Gray Plaid or Houndstooth.

**TM63CRGPM** ..... \$109.00/ea.  
**TM63CRHTM** ..... \$109.00/ea.

## SPARE TIRE COVER



Add the finishing touch to your trunk with a spare tire cover to match your trunk mat. Made from the same trunk mat material, these covers will fit any vehicle with a floor mounted spare tire. Please specify material pattern at time of order.

**ST14-15GP** (Gray Plaid) ..... \$59.00/ea.  
**ST14-15HT** (Houndstooth) ..... \$59.00/ea.  
**ST14-15HB** (Herringbone) ..... \$59.00/ea.  
**ST14-15TP** (Tan Plaid) ..... \$59.00/ea.  
 Ⓞ 1970 and later A & E-Body models used Herringbone.

## TRUNK MAT MATERIAL



Legendary Auto Interiors offers an uncut roll of trunk mat material in Houndstooth, Gray or Tan Plaid and Herringbone for models not offered. You cut to size this 52" x 80" roll.

**TMROLLHT** (Houndstooth) ..... \$89.00/ea.  
**TMROLLGP** (Gray Plaid) (shown) ..... \$89.00/ea.  
**TMROLLTP** (Tan Plaid) ..... \$89.00/ea.  
**TMROLLHB** (Herringbone) ..... \$89.00/ea.

## TRUNK DIVIDERS & JUTE INSULATION



Die-cut reproduction of the black fiberboard panel that separates the rear seat from the trunk compartment. Die-cut jute insulation helps reduce the amount of noise and heat from the trunk compartment.

### A-BODY MODELS

#### 1963-64 Dart & Dart GT

**TD63CL** <sup>OS1</sup> ..... \$51.00/ea.  
**TD63CLJ** (jute insulation) ..... \$34.00/ea.

#### 1963-65 Valiant

**TD63CV** (Hardtop & Sedan) <sup>OS1</sup> ..... \$41.00/ea.  
**TD63CVJ** (jute insulation) ..... \$27.00/ea.

#### 1965-66 Dart & Dart GT

**TD65CL** <sup>OS1</sup> ..... \$51.00/ea.  
**TD65CLJ** (jute insulation) ..... \$34.00/ea.

#### 1967-76 Dart, Dart GT & Scamp 1967-69 Valiant

**TD67CLV** <sup>OS1</sup> ..... \$41.00/ea.  
**TD67CLVJ** (jute insulation) ..... \$34.00/ea.

#### 1967-69 Barracuda

**TD67CBL** <sup>OS1</sup> ..... \$37.00/ea.  
**TD67CBLJ** (jute insulation) ..... \$24.00/ea.  
 Ⓞ Will not work for 1967-69 Barracuda "fastback" models.

#### 1970-76 Duster

#### 1971-72 Demon

#### 1973-76 Dart Sport

**TD70CV** <sup>OS1</sup> ..... \$37.00/ea.  
**TD70CVJ** (jute insulation) ..... \$34.00/ea.

### E-BODY MODELS

#### 1970-74 Barracuda

#### 1970-74 Challenger

**TD70CBJ** <sup>OS1</sup> ..... \$37.00/ea.  
**TD70CBJJ** (jute insulation) ..... \$24.00/ea.

## TRUNK SIDE PANEL COVERS

Die-cut reproduction side panels made of black fiberboard dress-up the trunk compartment by concealing the inner quarter panels.



**1973-74 Duster (w/ fold-down rear)** <sup>OS3</sup>  
**TP73CV** (Fastback - 3 pc.) (shown) ..... \$65.00/kit

## SPARE TIRE BOARD



Die-cut fiberboard panel for 1965-76 A-Body models fits over the spare tire well located under the trunk mat.

#### 1963-64 Dart & Valiant

**ST63CL** (shown) ..... \$26.00/ea.

#### 1965-76 Dart & Scamp

#### 1970-76 Duster

#### 1971-72 Demon

#### 1973-76 Dart Sport

**ST65CLV** ..... \$26.00/ea.

## SPARE TIRE COVER

#### 1964-66 Barracuda

**ST64CB** ..... \$26.00/ea.

#### 1967-69 Barracuda

**ST67CB** ..... \$26.00/ea.

#### 1965-76 A-Body

**ST65CLV** ..... \$26.00/ea.







# VINYL TOPS CONVERTIBLE TOPS AND ACCESORIES

 [facebook.com/legendaryautointeriors](https://facebook.com/legendaryautointeriors)

 [twitter.com/legendaryautoin](https://twitter.com/legendaryautoin)

 [www.legendaryautointeriors.com](http://www.legendaryautointeriors.com)

 [instagram.com/legendaryautointeriorsltd](https://instagram.com/legendaryautointeriorsltd)

 [youtube.com/user/legendaryauto](https://youtube.com/user/legendaryauto)



# VINYL TOPS

Legendary Auto Interiors, Ltd. "fitted" vinyl tops are manufactured to original specifications with the correct 100% cotton drill backing that gives trouble free installation and long term durability. All seams are double stitched and die-electrically heat-sealed insuring accurate deck width and seam durability. Each top is individually cut and fit for each specific year, make and model to give that perfect Legendary fit. Every Legendary vinyl top carries a (5) year factory warranty, the best in the industry!!

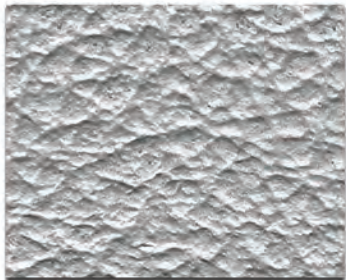

Levant Grain  
(1966-67)

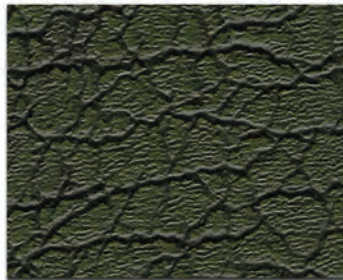

Boar Grain  
(1967-74)



Cobra Grain  
(1973-74)



Gator Grain  
(1969-70)

## GATOR GRAIN

Gator Grain vinyl tops were first available after mid-year 1969 as a custom group package option for Dodge and Plymouth C-Body models only. In 1970 Dodge and Plymouth broadened the optional Gator Grain vinyl top availability to its B and E-Body lines. These rare and highly valued vehicles are properly designated with the V1G vinyl top trim code found on the car's fender tag. Like all other Legendary Auto Interiors, Ltd. products, we have gone to great lengths accurately reproducing this most sought after material in the Mopar world. Gator grain tops are the correct "Antiqued" brown color with slight green tinting and have 1200 hours of level 5 UV (Ultra Violet) light protection with a heavy-weight cloth backing.



# ORIGINAL REPRODUCTION BOAR GRAIN



01 - Black



02 - White



03 - Antique Green

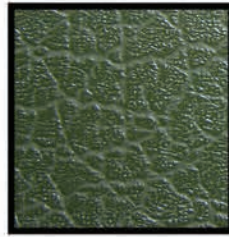

13 - Green



22 - Pearl White

## AS-ORIGINAL WIDE SEAM VINYL TOPS

Exclusively for 1970-72 Challenger only



### A-BODY MODELS CONT.

#### 1967-76 Dart & Dart GT

VTL10L3801L (Levant) (38" center deck width w/ valance & pillar post) ...	\$399.00/ea.
VTL10L3802L (Levant) (38" center deck width w/ valance & pillar post) ...	\$399.00/ea.
VTL10L3801 (Boar) (38" center deck width w/ valance & pillar post) ...	\$399.00/ea.
VTL10L3802 (Boar) (38" center deck width w/ valance & pillar post) ...	\$399.00/ea.
VTL10L3803 (Boar) (38" center deck width w/ valance & pillar post) ...	\$399.00/ea.
VTL10L3813 (Boar) (38" center deck width w/ valance & pillar post) ...	\$439.00/ea. (L4)
VTL10L3822 (Boar) (38" center deck width w/ valance & pillar post) ...	\$399.00/ea.
VTL10L4301L (Levant) (43" center deck width w/ valance & pillar post) ...	\$399.00/ea.
VTL10L4302L (Levant) (43" center deck width w/ valance & pillar post) ...	\$399.00/ea.
VTL10L4301 (Boar) (43" center deck width w/ valance & pillar post) ...	\$399.00/ea.
VTL10L4302 (Boar) (43" center deck width w/ valance & pillar post) ...	\$399.00/ea.
VTL10L4303 (Boar) (43" center deck width w/ valance & pillar post) ...	\$399.00/ea.
VTL10L4313 (Boar) (43" center deck width w/ valance & pillar post) ...	\$439.00/ea. (L4)
VTL10L4322 (Boar) (43" center deck width w/ valance & pillar post) ...	\$399.00/ea.

☞ 1967 models used Levant grain vinyl tops although some late production 1967 models can be found with Boar grain vinyl tops.

☞ White was not available in 1968-69 models but may be purchased as a special order.

#### 1967-69 Barracuda

VTL12B01L (Levant) (Hardtop - 41 1/2" center deck width).....	\$399.00/ea.
VTL12B02L (Levant) (Hardtop - 41 1/2" center deck width).....	\$399.00/ea.
VTL12B01 (Boar) (Hardtop - 41 1/2" center deck width) .....	\$399.00/ea.
VTL12B02 (Boar) (Hardtop - 41 1/2" center deck width) .....	\$399.00/ea.
VTL12B03 (Boar) (Hardtop - 41 1/2" center deck width) .....	\$399.00/ea.
VTL12B22 (Boar) (Hardtop - 41 1/2" center deck width) .....	\$399.00/ea.
VTL112B01L (Levant) (Hardtop - 34" center deck width).....	\$399.00/ea.
VTL112B01 (Boar) (Hardtop - 34" center deck width).....	\$399.00/ea.
VTL112B02 (Boar) (Hardtop - 34" center deck width).....	\$399.00/ea.
VTL112B03 (Boar) (Hardtop - 34" center deck width).....	\$399.00/ea.
VTL112B22 (Boar) (Hardtop - 34" center deck width).....	\$399.00/ea.
VTL13B01 (Boar) (1969 Fastback - 42" center deck & pillar post) .....	\$399.00/ea.
VTL13B03 (Boar) (1969 Fastback - 42" center deck & pillar post) .....	\$399.00/ea.
VTL13B22 (Boar) (1969 Fastback - 42" center deck & pillar post) .....	\$399.00/ea.
VTL113B01 (1969 Fastback - seamless deck & no pillar post) .....	\$229.00/ea.
VTL113B03 (1969 Fastback - seamless deck & no pillar post) .....	\$229.00/ea.
VTL113B22 (1969 Fastback - seamless deck & no pillar post) .....	\$229.00/ea.

#### 1970-76 Duster, 1971-72 Demon & 1973-76 Dart Sport

VTL11LV01 (Full top - 36 1/2" center deck width w/ pillar post).....	\$399.00/ea.
VTL11LV02 (Full top - 36 1/2" center deck width w/ pillar post).....	\$399.00/ea.
VTL11LV03 (Full top - 36 1/2" center deck width w/ pillar post).....	\$399.00/ea.
VTL11LV13 (Full top - 36 1/2" center deck width w/ pillar post).....	\$439.00/ea. (L4)
VTL15LV01 (Full top - 41" center deck width w/ pillar post) (shown).....	\$399.00/ea.
VTL15LV02 (Full top - 41" center deck width w/ pillar post) (shown).....	\$399.00/ea.
VTL15LV03 (Full top - 41" center deck width w/ pillar post) (shown).....	\$399.00/ea.
VTL15LV13 (Full top - 41" center deck width w/ pillar post) (shown).....	\$439.00/ea. (L4)
VTL117LV01 (3/4 "Canopy" top - 39 1/2" center deck width w/ pillar post).....	\$399.00/ea.
VTL117LV02 (3/4 "Canopy" top - 39 1/2" center deck width w/ pillar post).....	\$399.00/ea.
VTL117LV13 (3/4 "Canopy" top - 39 1/2" center deck width w/ pillar post).....	\$439.00/ea. (L4)
VTL118LV01 (3/4 "Canopy" top - seamless deck w/ pillar post) .....	\$399.00/ea.
VTL118LV02 (3/4 "Canopy" top - seamless deck w/ pillar post) .....	\$399.00/ea.

☞ Canopy top VTL117LV & VTL118LV for "1972-76" models only.

VTL118LVSNK (73-75 Gold Duster. NOS Snakeskin Grain).....Call for availability.

#### 1970-76 Dart Custom (4-door)

VTL17CL01 (39" center deck width) .....	\$399.00/ea.
VTL17CL02 (39" center deck width) .....	\$399.00/ea.
VTL17CL03 (39" center deck width) .....	\$399.00/ea.
VTL17CL13 (39" center deck width).....	\$439.00/ea. (L4)

### E-BODY MODELS

#### 1970-72 Challenger

VTL2J01 (Wide seam top 49" front & 64" rear center deck width w/ pillar post).....	\$595.00/ea.
VTL2J02 (Wide seam top 49" front & 64" rear center deck width w/ pillar post).....	\$595.00/ea.

#### 1970-74 Barracuda

#### 1970-74 Challenger (1970 - Antique Green) (1971-73 - Green) (1973-74 - Black & White)

VTL1BJ01 (Narrow seam top 31 3/4" center deck width w/ pillar post).....	\$379.00/ea.
VTL1BJ02 (Narrow seam top 31 3/4" center deck width w/ pillar post).....	\$379.00/ea.
VTL1BJ03 (Narrow seam top 31 3/4" center deck width w/ pillar post).....	\$379.00/ea.
VTL1BJ13 (Narrow seam top 31 3/4" center deck width w/ pillar post).....	\$439.00/ea. (L4)
VTL1BJ151 (Gator Grain 36" center deck width w/ pillar post).....	\$1295.00/ea. (L1)

### VINYL TOP TERMINOLOGY

**Pillar post** - The "A" pillar connects the roof to the body located between the windshield and door window. A vinyl top with pillar post runs all the way down the pillar to the bottom of the windshield.



**Valance** - This is the area under the rear window. If you have a vinyl top with a valance, then the vinyl top would wrap around the underside of the rear window.



**Center Deck** - The distance between the roof top seams measuring from the center of left seam (driver side) to the center of right seam (passenger side).



### COLOR CODES & YEARS APPLICABLE

(01) Black (1966-1974)	(13) Green (1971-1973) (L4)
(02) White (1966-1967 & 1970-74)	(22) Pearl White (1968-1969)
(03) Antique Green (1968-1970)	



VINYL TOPS - CONTINUED

**NOS VINYL TOPS**

Chrysler offered special order vinyl top colors and grain options such as Gator, Tortoise, Gold Reptile and Mod along with many others that are no longer manufactured and have not been reproduced. In our efforts to better serve you in your restoration needs, NOS (New Old Stock) vinyl top material is continuously being looked for. Please call for more information.

**VTNOS** ..... \$1129.00/ea.

☞ Please specify year/make/model, color, grain, with or without pillar posts, with or without rear valance & center deck width at time of order.

**SUN ROOF VINYL**

Additional vinyl top material for 1969-74 A & E-Body models with factory power or manual sun roof option. Sun roof material is 30" x 48". Please specify at time of order.

**1969-74 Boar Grain (Not Challenger)**

**VTSUNUNIV01** (Black no seams)..... \$80.00/ea.

**VTSUNUNIV02** (White no seams)..... \$80.00/ea.

**VTSUNUNIV03** (Antique Green no seams)..... \$80.00/ea.

**VTSUNUNIV13** (Green no seams)..... \$80.00/ea.

**VTSUNUNIV22** (Pearl White no seams) ..... \$80.00/ea.

**1970-72 Challenger**

**VTSUNCJ01** (Black)..... \$80.00/ea.

**VTSUNCJ02** (White)..... \$80.00/ea.

**1971-72 DUSTER / DEMON  
FOLDING SUN ROOF**

Sun roof material manufactured to factory specifications in original KV (Pinpoint) for 1971-72 Duster and Demon models with factory folding sun roof option. Available in black or white, please specify color at time of order.



KV "Pinpoint"

**VTSUN71CLV01P** (Black pinpoint) ..... \$399.00/ea.

**VTSUN71CLV02P** (White pinpoint)..... \$399.00/ea.

# CONVERTIBLE TOPS AND ACCESSORIES



Legendary Auto Interiors, Ltd. convertible tops are reproduced to factory original specifications. Convertible tops are available in original KV "Pinpoint" grain (1962-67 models) and Crush "Colonial" grain (1968-70 models). Convertible tops are handcrafted using correct heavyweight 36oz. material. Rear window curtains are available in glass or plastic depending on year, make and model. We also have convertible tops available for most 1950 to present models. For colors other than black and white and models not listed, please call for assistance. As with all Legendary Auto Interiors, Ltd. products, these reproduction convertible tops are the finest available and come with a (2) year manufacturer's warranty (glass curtains come with (1) year warranty) against defects in materials and workmanship.

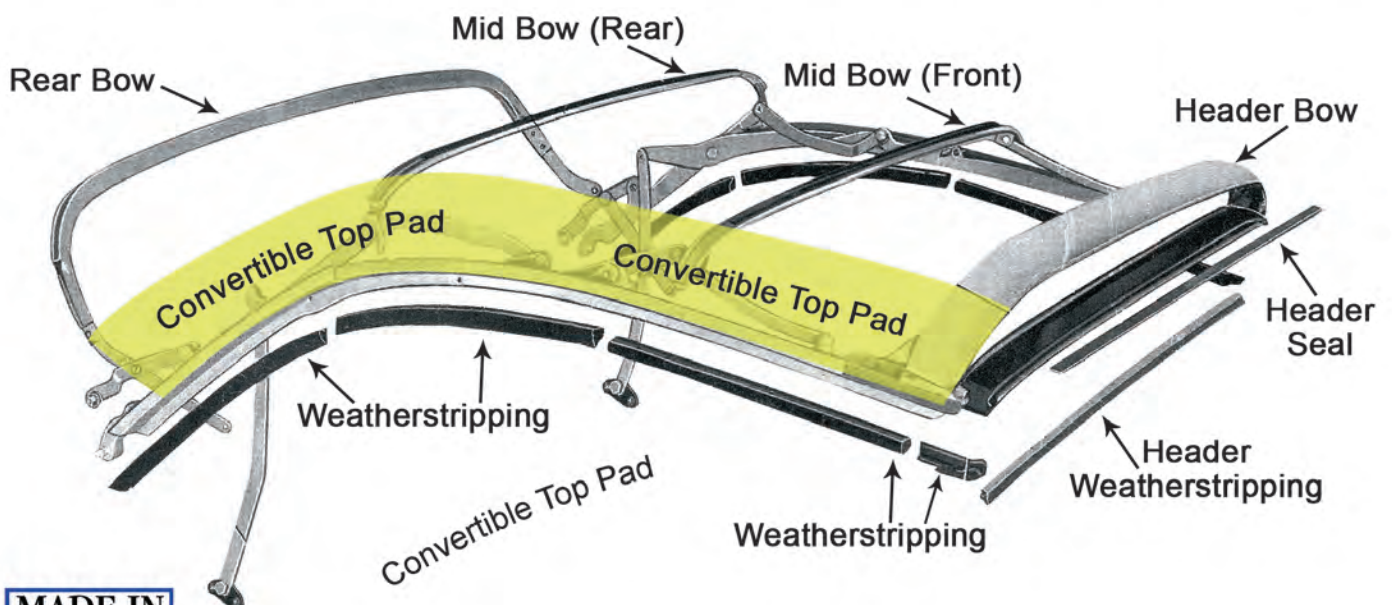

# Convertible Top Color Samples

## *K.V. "Pinpoint Grain" (1962-67)*

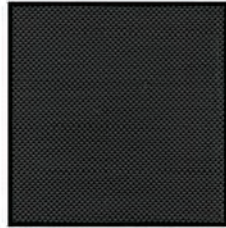

**01 Black**



**02 White**

## *Crush Grain (1968-70)*



**01 Black**



**02 White**

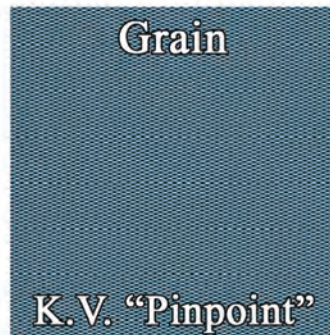

# Chrysler, Dodge, Plymouth

## CONVERTIBLE TOPS

### A-BODY MODELS

#### 1963-64 Dart & Dart GT

#### 1963-64 Valiant & Valiant Signet

CT63CLV(C)T (Black and White only) ..... \$459.00/ea.

CT63CLV-P (Plastic curtain only)  \$279.00/ea.

#### 1965-66 Dart & Dart GT

#### 1965-66 Valiant & Valiant Signet

CT65CLV(C)T (Black and White only) ..... \$399.00/ea.

CT65CLV-P (Plastic curtain only)  \$279.00/ea.

#### 1967 Dart & Dart GT

CT67CL(C)T (Black and White only) ..... \$399.00/ea.

CG67CL(C) (Glass curtain only)  \$399.00/ea.

\*\*\*GLASS IS SMALLER THAN THE ORIGINAL\*\*\*

DIMENSIONS ARE 42" X 14 1/2" X 45 1/2"

#### 1967 Barracuda

CT67CB(C)T (Black and White only) ..... \$399.00/ea.

CG67CB(C) (Glass curtain only)  \$399.00/ea.

#### 1968-69 Dart & Dart GT

CT68CL(C)T (Black and White only) ..... \$399.00/ea.

CG68CL(C) (Glass curtain only)  \$399.00/ea.

\*\*\*GLASS IS SMALLER THAN THE ORIGINAL\*\*\*

DIMENSIONS ARE 42" X 14 1/2" X 45 1/2"

#### 1968-69 Barracuda

CT68CB(C)T (Black and White only) ..... \$399.00/ea.

CG68CB(C) (Glass curtain only)  \$399.00/ea.

### E-BODY MODELS

#### 1970-71 Barracuda

#### 1970-71 Challenger

CT70CBJ(C)T (Black and White only) ..... \$399.00/ea.

CG70BJ(C) (Glass curtain only)  \$399.00/ea.

CTPAD70CBJ (Top pad) ..... \$79.00/pr.

## UNIVERSAL CONVERTIBLE TOP PADS



Universal convertible top pads fit between the top and metal frame rails, protecting the top from wear and damage. These will require some trimming but are a less expensive alternative to the OEM style. For the best possible fit, select your year specific OEM convertible top listed on this page. Convertible top pads are highly recommended with installation of new convertible tops.

CTPAD74STD ..... \$79.00/pr.

## ANTI-RATTLE PLATES



These plates mount to the frame header to align the top when closing and help to prevent rattling when top in its up position.

CT63AB-ANTIRAT (1963-69 A&B-Body) .. \$29.00/pr.

CT70E-ANTIRAT (1970 E-Body)..... discontinued

CT71E-ANTIRAT (1971 E-Body)..... \$39.00/pr.







# CONVERTIBLE BOOTS

All A, B, C & E-Body convertible boots are sewn to original factory specifications, using original grain vinyls. 1963-65 boot use Bison grain, 1966-68 use Cologne grain, 1969-71 use Coachman grain (except 1969 Dart GT models use Dakota grain). Each boot includes the correct plastic clips or metal snaps and improved padding. Please specify year, make, model and color code at time of order. On two-tone colored interior models, the boot will always match the skirting material on the upholstery. Please refer to the upholstery section in this catalog for correct color code.



# Chrysler, Dodge, Plymouth

## CONVERTIBLE BOOTS

All A & E-Body convertible boots are sewn to original factory specifications, using original grain vinyls. 1963-65 boots use Bison grain, 1966-68 use Cologne grain, 1969-71 use Coachman grain (except 1969 Dart GT models use Dakota grain). Each boot includes the correct plastic clips or metal snaps and improved padding. Please specify year, make, model and color code at time of order. On two-tone colored interior models, the boot will always match the skirting material on the upholstery. Please refer to the upholstery section in this catalog for correct color code.



A-BODY MODELS

### 1963 Dart & Dart GT

- CB63CL00017206 (Taupe)..... \$399.00/ea.
- CB63CL00017302 (Blue)..... \$399.00/ea.
- CB63CL00017406 (Light Turquoise).. \$399.00/ea.
- CB63CL00017510 (Crimson Red)..... \$399.00/ea.

### 1964-66 Dart & Dart GT

#### 1964-65

- CB64CL00017100 (Black)..... \$399.00/ea.
- CB64CL00017202 (Pearl White)..... \$399.00/ea.
- CB64CL00017314 (Metallic Blue)..... \$399.00/ea.
- CB64CL00017318 (Lt Met Blue)..... \$399.00/ea.
- CB64CL00017505 (Red)..... \$399.00/ea.
- CB64CL00017510 (Crimson Red)..... \$399.00/ea.
- CB64CL00017520 (Metallic Red)..... \$399.00/ea.
- CB64CL00017610 (Metallic Fawn).... \$399.00/ea.
- CB64CL00017614 (Gold)..... \$399.00/ea.
- CB64CL00017410 (Lt Met Olive).... \$729.00/ea.(L1)

#### 1966

- CB66CL00017100 (Black)..... \$399.00/ea.
- CB66CL00017202 (Pearl White)..... \$399.00/ea.
- CB66CL00017314 (Metallic Blue)..... \$399.00/ea.
- CB66CL00017318 (Lt Met Blue)..... \$399.00/ea.
- CB66CL00017505 (Red)..... \$399.00/ea.
- CB66CL00017510 (Crimson Red)..... \$399.00/ea.
- CB66CL00017520 (Metallic Red)..... \$399.00/ea.
- CB66CL00017610 (Metallic Fawn).... \$399.00/ea.
- CB66CL00017614 (Gold)..... \$399.00/ea.

### 1967-68 Dart & Dart GT

- CB67CL00017100 (Black)..... \$399.00/ea.
- CB67CL00017202 (Pearl White)..... \$399.00/ea.
- CB67CL00017320 (Metallic Navy).... \$399.00/ea.
- CB67CL00017332 (Lt Met Blue)..... \$399.00/ea.
- CB67CL00017430 (Dk Met Green).... \$399.00/ea.
- CB67CL00017520 (Metallic Red)..... \$399.00/ea.
- CB67CL00017620 (Copper)..... \$399.00/ea.
- CB67CL00017636 (Ember Gold)..... \$399.00/ea.

## A-BODY MODELS CONT.

### 1969 Dart & Dart GT

- CB69CL00017100 (Black).....\$399.00/ea.
- CB69CL00017202 (Pearl White).....\$399.00/ea.
- CB69CL00017332 (Lt Met Blue).....\$399.00/ea.
- CB69CL00017432 (Lt Met Green)....\$399.00/ea.
- CB69CL00017507 (Red).....\$399.00/ea.
- CB69CL00017630 (Gold).....\$399.00/ea.

### 1965-66 Valiant & Valiant Signet

#### 1965

- CB65CV00017100 (Black).....\$399.00/ea.
- CB65CV00017314 (Metallic Blue)....\$399.00/ea.
- CB65CV00017318 (Lt Met Blue).....\$399.00/ea.
- CB65CV00017505 (Red).....\$399.00/ea.
- CB65CV00017510 (Crimson Red)....\$399.00/ea.
- CB65CV00017614 (Gold).....\$399.00/ea.

#### 1966

- CB66CV00017100 (Black).....\$399.00/ea.
- CB66CV00017314 (Metallic Blue)....\$399.00/ea.
- CB66CV00017318 (Lt Met Blue).....\$399.00/ea.
- CB66CV00017505 (Red).....\$399.00/ea.
- CB66CV00017510 (Red).....\$399.00/ea.
- CB66CV00017614 (Gold).....\$399.00/ea.

### 1967-68 Barracuda

- CB67CB00017100 (Black).....\$399.00/ea.
- CB67CB00017202 (Pearl White)....\$399.00/ea.
- CB67CB00017320 (Metallic Navy) ..\$399.00/ea.
- CB67CB00017332 (Lt Met Blue).....\$399.00/ea.
- CB67CB00017430 (Dk Met Green) ..\$399.00/ea.
- CB67CB00017520 (Metallic Red)....\$399.00/ea.
- CB67CB00017526 (Met Maroon)....\$399.00/ea.
- CB67CB00017620 (Cooper).....\$399.00/ea.
- CB67CB00017636 (Ember Gold)....\$399.00/ea.
- CB67CB00017618 (Lt Gold) ... \$729.00/ea.(L1)

### 1969 Barracuda

- CB69CB00017100 (Black).....\$399.00/ea.
- CB69CB00017130 (Pewter).....\$399.00/ea.
- CB69CB00017200 (White).....\$399.00/ea.
- CB69CB00017338 (Bright Blue).....\$399.00/ea.
- CB69CB00017434 (Dk Met Green) ..\$399.00/ea.
- CB69CB00017528 (Red).....\$399.00/ea.
- CB69CB00017644 (Sun Gold Yellow).\$399.00/ea.
- CB69CB00017650 (Saddle).....\$399.00/ea.

## E-BODY MODELS

### 1970-71 Barracuda

- CB70CB00017100 (Black).....\$469.00/ea.
- CB70CB00017154 (Charcoal).....\$469.00/ea.
- CB70CB00017200 (White).....\$469.00/ea.
- CB70CB00017338 (Bright Blue).....\$469.00/ea.
- CB70CB00017340 (Bright Blue).....\$469.00/ea.
- CB70CB00017434 (Dk Met Green) ..\$469.00/ea.
- CB70CB00017452 (Metallic Green)..\$469.00/ea.
- CB70CB00017540 (Burnt Orange) ...\$469.00/ea.
- CB70CB00017550 (Red).....\$469.00/ea.
- CB70CB00017656 (Brown).....\$469.00/ea.
- CB70CB00017664 (Brown).....\$469.00/ea.
- CB70CB00017666 (Ember Gold).....\$469.00/ea.
- CB70CB00017660 (Gold).....\$729.00/ea. (L1)

### 1970-71 Challenger

- CB70CJ00017100 (Black)..... \$469.00/ea.
- CB70CJ00017200 (White)..... \$469.00/ea.
- CB70CJ00017338 (Bright Blue)..... \$469.00/ea.
- CB70CJ00017340 (Bright Blue)..... \$469.00/ea.
- CB70CJ00017434 (Dk Met Green) ... \$469.00/ea.
- CB70CJ00017452 (Metallic Green) .. \$469.00/ea.
- CB70CJ00017540 (Burnt Orange).... \$469.00/ea.
- CB70CJ00017550 (Red)..... \$469.00/ea.
- CB70CJ00017656 (Brown)..... \$469.00/ea.
- CB70CJ00017664 (Brown)..... \$469.00/ea.
- CB70CJ00017666 (Ember Gold)..... \$469.00/ea.

## CONVERTIBLE BOOT CLIPS



Reproduction plastic clips that get sewn into the convertible top boot for attachment.

- CB70E-CLIP (1970-71 E-Body).....\$5.00/ea.

## CONVERTIBLE BOOT DUST COVER

Protect your convertible boot when you remove it with this convertible boot dust cover made in Levant grain with a satin finish. Comes in Black only



- CB67MCBAG01..... \$39.00/ea.



**CONVERTIBLE WELL LINERS**

Legendary Auto Interiors, Ltd. convertible top well liners for A & E-Body models are manufactured to original specifications with plastic strips and snaps (where applicable) for easy installation. The well liner installs behind the convertible rear seat protecting the top from damage when placed in the down position. Available in black for all years or in matching colors for 1963-65 model interiors.



A-BODY MODELS

**1963 Dart & Dart GT**

- WL63CL00016206 (Taupe)..... \$229.00/ea.
- WL63CL00016302 (Blue)..... \$229.00/ea.
- WL63CL00016406 (Lt Turquoise)..... \$229.00/ea.
- WL63CL00016510 (Crimson Red)..... \$229.00/ea.

**1965-66 Valiant & Valiant Signet**

- WL65CV00016100 (Black)..... \$229.00/ea.
- WL65CV00016314 (Metallic Blue) ..... \$229.00/ea.
- WL65CV00016318 (Lt Met Blue) ..... \$229.00/ea.
- WL65CV00016505 (Red)..... \$229.00/ea.
- WL65CV00016510 (Crimson Red)..... \$229.00/ea.
- WL65CV00016614 (Gold)..... \$229.00/ea.

**1964-66 Dart & Dart GT**

- WL64CL00016100 (Black)..... \$229.00/ea.
- WL64CL00016314 (Metallic Blue) ..... \$229.00/ea.
- WL64CL00016510 (Crimson Red)..... \$229.00/ea.
- WL64CL00016610 (Metallic Fawn).... \$229.00/ea.
- WL64CL00016410 (Lt Met Olive) ... \$530.00/ea. (L1)

**1967-69 Dart & Dart GT**

- WL67CL00016100 (Black)..... \$229.00/ea.
- ☞ Available in black only.

**1967-69 Barracuda**

- WL67CB00016100 (Black)..... \$229.00/ea.
- ☞ Available in black only.

E-BODY MODELS

**1970-71 Barracuda**

**1970-71 Challenger**

- WL70CBJ0016100 (Black)..... \$229.00/ea.
- ☞ Available in black only.

**CONVERTIBLE TOP LATCH**



1967-69 A-Body convertible top latch

- CT65ABC-LATCH.....\$169.00/pr.

**CONVERTIBLE BODY SCREW STUDS**







5/8" Phillips head stainless steel body screw studs for snap down boot and well liner applications.

- CBBOOTBEZSCRW (Pkg/35) .....\$16.00/pk.



# WEATHERSTRIPING AND ACCESORIES

 [facebook.com/legendaryautointeriors](https://facebook.com/legendaryautointeriors)  
 [twitter.com/legendaryautoin](https://twitter.com/legendaryautoin)

 [www.legendaryautointeriors.com](http://www.legendaryautointeriors.com)  
 [instagram.com/legendaryautointeriorsltd](https://instagram.com/legendaryautointeriorsltd)  
 [youtube.com/user/legendaryauto](https://youtube.com/user/legendaryauto)

## BODY PLUG KITS



Complete body plug kits for floor pans, trunk pans and trunk extensions contain the correct size and style plugs in plastic or rubber depending on location and application of each year and model.

### A-BODY MODELS

<b>1964-66 Barracuda 1963-66 Dart &amp; Valiant</b> BP64CB .....	\$49.00/kit
<b>1967-69 Dart &amp; Dart GT 1967-69 Barracuda</b> BP67A .....	\$59.00/kit
<b>1970-74 Dart 1970-74 Scamp &amp; Duster 1971-72 Demon 1973-74 Dart Sport</b> BP70A .....	\$59.00/kit

### E-BODY MODELS

<b>1970 Challenger</b> BP70CJ .....	\$69.00/kit
<b>1970 Barracuda</b> BP70CB .....	\$69.00/kit
<b>1971-74 Challenger 1971-74 Barracuda</b> BP71E .....	\$69.00/kit

### SPRING-LOADED HOOD BUMPERS

Spring-loaded hood bumpers for 1970-74 E-Body models. This wedge-shaped bumper keeps the hood in alignment.



**BU69WEDGE**.....\$15.00/ea.

## BODY BUMPER KITS

Complete body bumper kits for 1963-74 A & E-Body models. These kits include all of the body bumpers on your car from the hood to the trunk. Spring-loaded hood wedges are included in 1969-74 kits where applicable.



### A-BODY MODELS

<b>1963 Dart, Dart GT &amp; Valiant</b> BU63CBL-C .....	\$29.00/kit
<b>1964-66 Dart, Dart GT, Barracuda</b> BU64CBL-C .....	\$29.00/kit
<b>1967-70 Dart &amp; Dart GT 1970 Duster</b> BU67CBL-C .....	\$29.00/kit
<b>1967-69 Barracuda 1967-69 Valiant &amp; Valiant Signet</b> BU67CBL-C .....	\$29.00/kit
<b>1971 Duster 1971 Dart &amp; Demon</b> BU71CLV-C .....	\$29.00/kit
<b>1972 Dart &amp; Demon 1972-74 Duster 1973-74 Dart Sport 1974 Dart</b> BU72CLV-C .....	\$29.00/kit
<b>1973 Dart</b> BU73CLV-C .....	\$29.00/kit

### E-BODY MODELS

<b>1970 Challenger</b> BU70CJ-C .....	\$59.00/kit
<b>1970 Barracuda</b> BU70CB-C .....	\$59.00/kit
<b>1971 Challenger</b> BU71CJ-C .....	\$59.00/kit
<b>1971 Barracuda</b> BU71CB-C .....	\$59.00/kit
<b>1972-74 Challenger</b> BU72CJ-C .....	\$69.00/kit
<b>1972 &amp; 74 Barracuda</b> BU72CB-C .....	\$39.00/kit
<small>☞ Spring loaded hood wedges <u>not</u> included in this kit.</small>	
<b>1973 Barracuda</b> BU73CB-C .....	\$55.00/kit

## TRUNK BUMPER KIT

Rubber bumpers for 1966-74 A & E-Body models keeps the trunk lid in alignment. (NOTE: Contents of this kit are also included in the complete body bumper kits)

**BU66ABTRNK**.....\$3.00/ea.

## HOOD BUMPER KITS

Bumper kit includes all the necessary bumpers for under the hood of your car. (NOTE: Contents of this kit are also included in the complete body bumper kits)

### A-BODY MODELS

<b>1963 Dart, Dart GT &amp; Valiant</b> BU63CBLV-H .....	\$29.00/kit
<b>1964-66 Dart, Dart GT, Valiant &amp; Barracuda</b> BU64CBLV-H .....	\$29.00/kit
<b>1967-70 Dart &amp; Dart GT 1970 Duster</b> BU67CBLV-H .....	\$29.00/kit
<b>1967-69 Barracuda 1967-69 Valiant &amp; Valiant Signet</b> BU67CBLV-H .....	\$29.00/kit
<b>1971-72 Demon 1971-74 Scamp &amp; Duster 1971-74 Dart 1973-74 Dart Sport</b> BU71CLV-H .....	\$29.00/kit

### E-BODY MODELS

<b>1970-74 Challenger</b> BU70CJ-H .....	\$49.00/kit
<b>1970-71 &amp; 73 Barracuda</b> BU70CB-H .....	\$49.00/kit
<b>1972 &amp; 74 Barracuda</b> BU72CB-H .....	\$29.00/kit

## ACCELERATOR GASKETS



Die-cut white foam gaskets install under the accelerator pedal to prevent water damage.

<b>1967-74 A-Body (all models)</b> GK67A-ACCEL .....	\$7.00/ea.
<b>1970-74 E-Body (all models)</b> GK70EB-ACCEL .....	\$6.00/ea.



**DOOR HANDLE GASKETS**



Die-cut door handle gaskets mount between the door handle and door.

- 1967-70 A-Body (all models)**  
GK67AB-DH (Rubber) (shown).....\$5.00/pr.
- 1970-74 E-Body (all models)**  
GK70E-DH (Plastic).....\$5.00/pr.

**DOOR & TRUNK LOCK GASKETS**



Gray plastic door and trunk lock gaskets for 1966-71 A & E-Body models mount between the lock mechanism and body.

- GK66LOCKDT.....\$5.00/kit

**WINDOW TRIM CLIPS**



Trim clip kits include both front windshield and rear window clips (where applicable) for fastening trim molding. Mounting screws included.

A-BODY MODELS

- 1964 Dart & Dart GT**  
WG64CL-CLIP (Hardtop)..... \$59.00/kit
- 1968-69 Barracuda**  
WG68CBN-CLIP (Hardtop)..... \$59.00/kit  
WG68CBF-CLIP (Fastback)..... \$59.00/kit  
WG68CBLVC-CLIP (Convertible) ..... \$39.00/kit
- 1968-76 Dart & Dart GT**  
**1968-76 Valiant & Scamp**  
WG68CBLV-CLIP (Hardtop) ..... \$59.00/kit  
WG68CBLVC-CLIP (Convertible) ..... \$39.00/kit
- 1970-76 Duster**  
**1971-72 Demon**  
**1973-76 Dart Sport**  
WG70CV-CLIP ..... \$59.00/kit

E-BODY MODELS

- 1970 Barracuda & Challenger**  
WG70CBJ-CLIP (Hardtop)..... \$59.00/kit  
WG70CBJC-CLIP (Convertible)..... \$39.00/kit
- 1971-74 Barracuda & Challenger**  
WG71CBJ-CLIP (Hardtop)..... \$59.00/kit  
WG70CBJC-CLIP (Convertible)..... \$39.00/kit

**WINDSHIELD GASKETS**

Remanufactured rubber windshield gaskets made as original for A-Body and Dodge pickups.

A-BODY MODELS

- 1963-66 Dart & Dart GT**  
**1963-66 Valiant & Valiant Signet**  
WG63CBLV-WG (Hardtop) ..... \$119.00/ea.
- 1964-66 Barracuda**  
WG63CBLV-WG (Fastback)..... \$119.00/ea.
- 1968-69 Barracuda**  
WG68CBLV-WG (Hardtop & Fstback)\$119.00/ea.
- 1968-76 Dart & Dart GT**  
**1968-76 Valiant & Scamp**  
WG68CBLV-WG (Hardtop) ..... \$119.00/ea.
- 1970-76 Duster**  
**1971-72 Demon**  
**1973-76 Dart Sport**  
WG70CLV-WG (Fastback) ..... \$119.00/ea.

DODGE TRUCK

- 1972-93 Dodge Pickup**  
WG72CDT-WG..... \$119.00/ea.

**REAR WINDOW GASKETS**

Remanufactured rubber rear window gaskets made as original for A-Body models where applicable.

A-BODY MODELS

- 1964-66 Barracuda**  
WG64CBFSB-RG (Fastback) ..... \$119.00/ea.
- 1965-66 Dart & Dart GT**  
WG64CL-RG (Hardtop & Sedan)....\$189.00/ea.
- 1968-69 Barracuda**  
WG68CBN-RG (Hardtop).....\$259.00/ea.  
WG68CBFSB-RG (Fastback) .....\$119.00/ea.
- 1968-76 Dart & Dart GT**  
**1968-76 Valiant & Scamp**  
WG68CLV-RG (Hardtop).....\$119.00/ea.
- 1970-76 Duster**  
**1971-72 Demon**  
**1973-76 Dart Sport**  
WG70CLV-RG (Fastback) ..... \$139.00/ea.

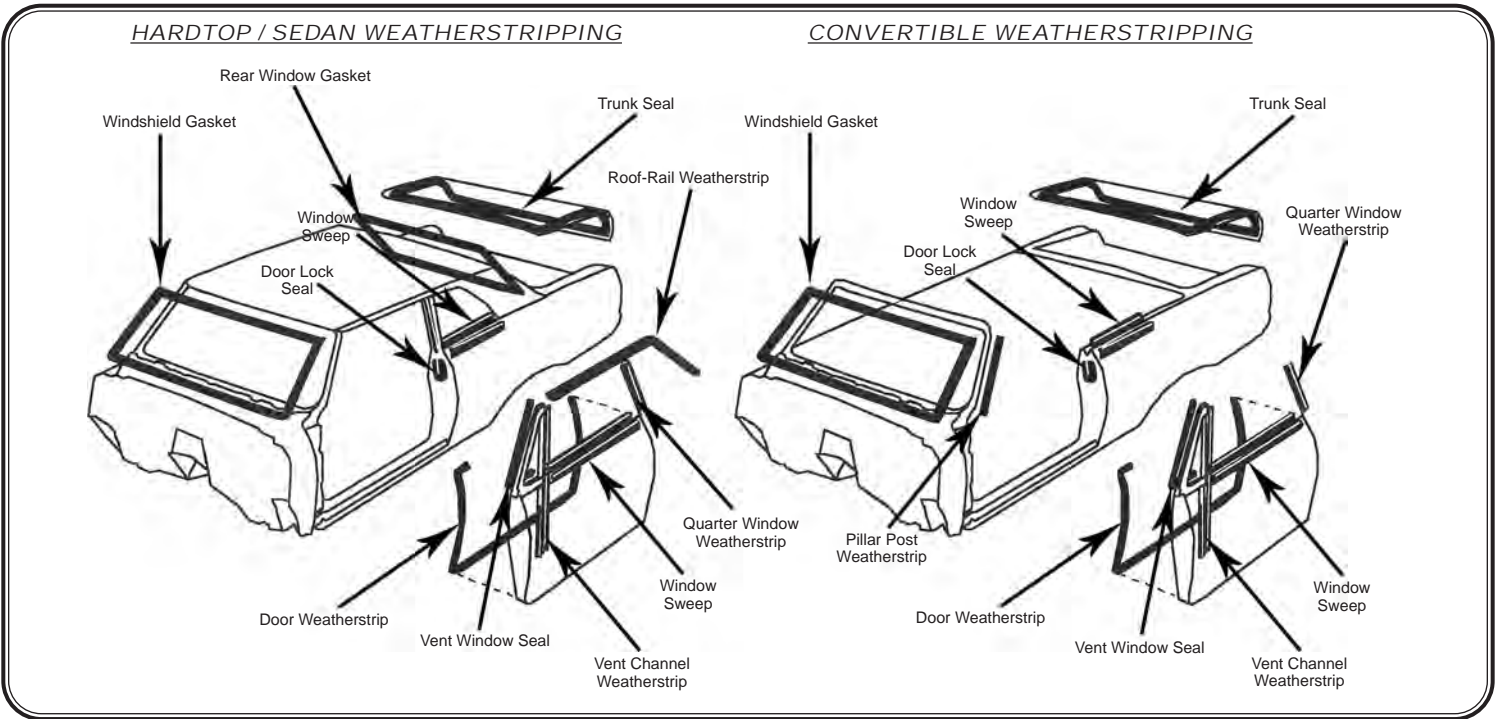

## DOOR WEATHERSTRIPPING

Thick molded rubber weatherstrip includes the necessary clips and correct molded endpads for an excellent fit. These pieces wrap around the bottom and sides of each door.

### 1967-72 A-Body (all models)

**WS67C-ADOOR** (Hardtop/Conv.).....\$139.00/pr.

### 1973-76 A-Body (all models)

**WS73C-ADOOR** (Hardtop).....\$149.00/pr.

### 1970-74 E-Body (all models)

**WS70C-EDOOR** (Hardtop/Conv.).....\$129.00/pr.

## DOOR WEATHERSTRIPPING CLIPS



Plastic door weatherstripping kits replace missing or broken originals. For all 1966 and later models. (NOTE: These clips are replacements only and are already included with the door weatherstripping shown above)

**WS63CDOORCLIPS** (22/pkg)..... \$15.00/pk.

## DOOR LOCK SEALS



These molded rubber "U" shaped seals screw onto the door jamb pillar to seal the front edge of the rear-door windows.

### 1970-74 E-Body (all models)

**WS70C-EDOORLOCK** (shown).....\$59.00/pr.

## DOOR WINDLACE WEATHERSTRIP

Reproduction door windlace with steel core for 1962-65 2-Door models. This windlace pushes onto the lip of the door jamb sealing the doors when shut.

**WS62C-DOOR(C)** (Hardtop/Conv.)..... \$169.00

**WS62C-SDOOR(C)** (Sedan)..... \$189.00

Available colors: (01) Black, (03) Red, (11) Light Blue, (50) Turquoise.

## DOOR END/LOCK SEAL SCREW



Black #8 door-end and door-lock 3/8" screw replaces broken or missing originals on all B & E-Body 2-door models.

**WS68DOORSCREW** (10/pkg).....\$10.00/pk.

## DOOR END SEALS



Molded rubber seals mount to end of the door next to the top of the door weatherstripping and are attached with screws.

### 1970-74 E-Body (all models)

**WS70C-EDOOREND**.....\$69.00/pr.



## ROOF RAIL WEATHERSTRIPPING

Thick molded rubber with correct molded endpads. These start at the base of the windshield pillar post and follow along the outer edge of the roofline to the rear of the quarter window.

- 1964-66 A-Body (Barracuda)**  
WS64C-AROOF (Fastback).....\$129.00/pr.
- 1967-69 A-Body (Barracuda)**  
WS67C-AFROOF (Fastback).....\$149.00/pr.
- 1967-72 A-Body (all models)**  
WS67C-AROOF (Hardtop).....\$149.00/pr.
- 1973-76 A-Body (all models)**  
WS73C-AROOF (Hardtop).....\$129.00/pr.
- 1970-76 A-Body (all models)**  
WS70C-AFROOF (Fastback).....\$129.00/pr.
- 1970 E-Body (all models)**  
WS70C-EROOF (Hardtop) \$129.00/pr.
- 1971-74 E-Body**  
WS71C-EROOF (Hardtop).....\$129.00/pr.

## REAR QUARTER WINDOW SEALS

Rubber seals install into the chrome tracks located on the front edge of the quarter windows for some models and on the back edge of the door windows for others.

- 1967-69 A-Body (all models)**  
WS66C-BQTR (Convertible).....\$29.00/pr.
- 1967-69 A-Body (Barracuda)**  
WS67C-BQTRH (Hardtop).....\$29.00/pr.  
WS67C-AQTRF (Fastback).....\$29.00/pr.
- 1967-72 A-Body (Dart & Dart GT)**  
WS66C-BQTR (Hardtop).....\$16.00/pr.
- 1970-74 A-Body (Duster, Demon & Dart Sport)**  
WS70C-AQTR (Fastback).....\$129.00/pr.
- 1970 E-Body (all models)**  
WS70C-EQTR (Hardtop & Conv.).....\$49.00/pr.
- 1971-74 E-Body**  
WS71C-EQTR (Hardtop & Conv.).....\$49.00/pr.

## TRUNK SEALS

Correct original profile extruded foam for hardtop and convertible models seals the trunk lid preventing water leaks.

- 1967-69 Dart & Dart GT**  
TS67CL (Hardtop & Convertible).....\$59.00/ea.
- 1967-69 (Barracuda)**  
TS67CBHC (Hardtop & Conv.).....\$59.00/ea.  
TS67CBFBK (Fastback).....\$59.00/ea.
- 1970 Dart**  
TS70CL (Hardtop).....\$49.00/ea.
- 1970-76 Duster**  
**1971-72 Scamp**  
**1971-72 Dart & Demon**  
**1973-76 Dart Sport**  
TS70CLV (Hardtop & Fastback).....\$29.00/ea.
- 1973-76 Dart & Scamp**  
TS73CLV (Hardtop).....\$29.00/ea.
- 1970-72 E-Body (all models)**  
TS70CBJ (Hardtop & Convertible).....\$29.00/ea.
- 1973-74 E-Body (all models)**  
TS73CBJ (Hardtop).....\$49.00/ea.

## CHRYSLER "V-FOAM" TRUNK SEAL



Extruded "V" shape foam for all 1963-74 models seals the trunk lid preventing water leaks. Please measure original seal for correct footage when ordering.

- TS63VFOAM**.....\$5.00/ft.

## VENT WINDOW SEAL



Rubber "wing" vent window seal fits inside the framing for the glass vent window.

- 1978-1986 Dodge Pickup**  
WS78D150VENTSEAL.....\$59.00/ea.

## CONVERTIBLE TOP FRAME WEATHERSTRIPPING

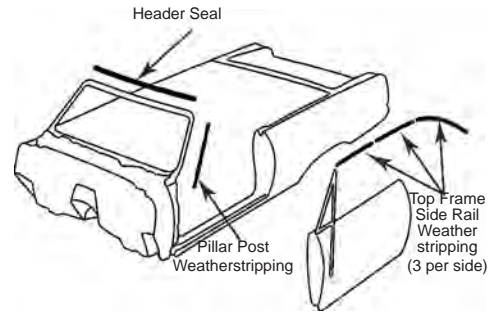

## CONVERTIBLE TOP FRAME WEATHERSTRIPPING KITS

Complete convertible top frame kits consist of (1) rubber header seal, (1) secondary rubber header seal and (6) molded rubber side rail pieces.

- 1967-69 A-Body (all models)**  
WS66CBLRVVWXTOP.....\$149.00/kit
- 1970-71 E-Body (all models)**  
WS70CBJTOP.....\$179.00/kit

## PILLAR POST WEATHERSTRIPPING

These weatherstrip pieces run along the side of the windshield frame.

- 1970-71 E-Body (all models)**  
WS70CBJPOST.....\$89.00/pr.

## HEADER SEALS

Rubber header seal runs along the front of the top and seals against the top of the windshield.

- 1967-69 A-Body (all models)**  
WS67CBLVHS.....\$89.00/ea.
- 1970-71 E-Body (all models)**  
WS70CBJHS.....\$89.00/ea.



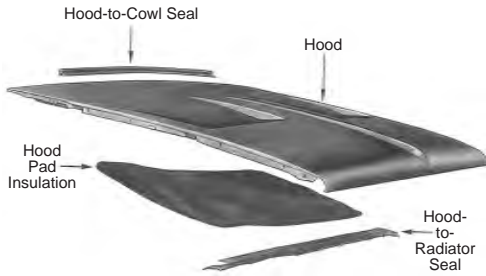

## HOOD-TO-COWL SEALS



This rubber piece seals to the underside of the hood to the front edge of the cowl.

### 1963-66 A-Body (all models)

WS63C-AHOOD1 (w/ clips installed) ...\$59.00/ea.

### 1967-74 A-Body (all models)

WS67C-AHOOD.....\$15.00/ea.

### 1970-74 E-Body (all models)

WS70C-EHOOD.....\$19.00/ea.

WS70C-EHOOD1 (w/ clips installed) ...\$79.00/ea.

## HOOD-TO-RADIATOR SEALS



Correctly formed and shaped rubber strip that seals the hood to the radiator core support.

### 1967-69 Barracuda & Dart

#### 1971-72 Demon

#### 1967-72 Valiant & 1970-72 Duster

WS67CBLV-HR (w/ clips installed) ..... \$89.00/ea.

### 1970-71 Dart

WS70CL-HR (w/ clips installed)..... \$119.00/ea.

### 1972-75 Dart & Dart Sport

#### 1973-75 Valiant & Duster

WS72CL-HR (w/ clips installed)..... \$109.00/ea.

### 1970-71 E-Body (all models)

WS70CBJ-HR (w/ clips installed) ..... \$119.00/ea.

### 1972-74 E-Body (all models)

WS72CBJ-HR (w/ clips installed) ..... \$89.00/ea.

## MOLDED HOOD PAD

These pads are molded to the shape of the hood as original. Due to size of these hood pads, they are shipped oversize.



### 1967-69 A-Body (Barracuda)

HP67CBM (requires 18 clips)..... \$119.00/ea.

### 1967-76 A-Body

HP67CLVM (requires 18 clips)..... \$119.00/ea.

### 1970-74 E-Body (all models)

HP70CBJXM (requires 20 clips) ..... \$119.00/ea.

## HOOD PAD INSULATION

Die-cut reproductions of the original hood insulation pads ready to install. Clips not included.



## A-BODY MODELS

### 1964-69 Barracuda

HP64CB (1964-65) (requires 21 clips) ..\$39.00/ea.

HP66CB (1966) (requires 20 clips) .....\$39.00/ea.

HP67CBLV (1967-69) (requires 18 clips) ..\$49.00/ea.

### 1963-66 Valiant

HP63CV (1963) (requires 22 clips).....\$49.00/ea.

HP64CV (1964-65) (requires 22 clips) ..\$49.00/ea.

HP66CV (requires 23 clips) .....\$49.00/ea.

### 1963-76 Dart & Dart GT

#### 1971-72 Demon

#### 1973-76 Dart Sport

#### 1970-76 Duster

#### 1971-76 Scamp

HP63CL (1963) (requires 22 clips).....\$49.00/ea.

HP64CL (1964) (requires 22 clips).....\$39.00/ea.

HP65CL (1965) (requires 22 clips).....\$39.00/ea.

HP66CL (1966) (requires 23 clips).....\$39.00/ea.

HP67CBLV (1967-76) (requires 18 clips) ..\$49.00/ea.

## E-BODY MODELS

### 1970-74 Barracuda & Challenger

HP70CBJX (requires 20 clips) ..... \$39.00/ea.

## DODGE TRUCK

### 1967-71 Dodge Truck

HP67CDT ..... \$29.00/ea.

## METAL HOOD PAD CLIPS



1962-65



1966-71

Reproductions of the original stamped metal hood pad clips for all 1962-65 and 1966-71 models.

HPCLIP-M62 (1962-65).....\$3.00/ea.

HPCLIP-M (1966-71).....\$3.00/ea.

## PLASTIC HOOD PAD CLIPS



Reproduction plastic hood pad clips for all 1972 and later models.

HPCLIP-P .....\$1.00/ea.



**WINDOW SWEEP KITS**

Reproduction window sweep kits consist of felt-lined pieces for sealing the side glass to the door or quarter panel. Reproduced as close to original as possible, each kit is model specific and includes the chrome or black metal backing strip. Available in 4 piece kits (outer sweeps only) or complete 6, 8 and 10 piece kits (inner and outer sweeps).



A-BODY MODELS

- 1963-66 Dart & Dart GT**  
 WS63WX14108 (Conv.) (8 pc.) ..... \$119.00/kit  
 WS63WX24104 (Conv.) (4 pc.) ..... \$ 79.00/kit  
 WS63WX14508 (HTP) (8 pc.) ..... \$119.00/kit  
 WS63WX24504 (HTP) (4 pc.) ..... \$ 79.00/kit  
 WS63WW14308 (Sedan) (8 pc.) ..... \$119.00/kit  
 WS63WW24304 (Sedan) (4 pc.) ..... \$ 79.00/kit

- 1963-66 Valiant & Valiant Signet**  
 WS63WX14108 (Conv.) (8 pc.) ..... \$119.00/kit  
 WS63WX24104 (Conv.) (4 pc.) ..... \$ 79.00/kit  
 WS63WX14408 (HTP) (8 pc.) ..... \$119.00/kit  
 WS63WX24404 (HTP) (4 pc.) ..... \$ 79.00/kit  
 WS63WW14208 (Sedan) (8 pc.) ..... \$119.00/kit  
 WS63WW24204 (Sedan) (4 pc.) ..... \$ 79.00/kit

- 1964-66 Barracuda**  
 WS64WX14006 (Fastback) (8 pc.).... \$ 99.00/kit  
 WS64WX24004 (Fastback) (4 pc.).... \$ 99.00/kit

- 1967-69 Barracuda**  
 WS67WW11308 (Conv.) (8 pc.) ..... \$179.00/kit  
 WS67WX21504 (Conv.) (4 pc.) ..... \$119.00/kit  
 WS67WX11008 (HTP) (8 pc.) ..... \$179.00/kit  
 WS67WX29704 (HTP) (4 pc.) ..... \$119.00/kit  
 WS67WW10908 (Fastback) (8 pc.)... \$179.00/kit  
 WS67WW20904 (Fastback) (4 pc.)... \$119.00/kit

- 1967-69 Dart & Dart GT**  
 WS67WX11108 (Conv.) (8 pc.) ..... \$179.00/kit  
 WS67WX21604 (Conv.) (4 pc.) ..... \$119.00/kit  
 WS67WX11208 (HTP) (8 pc.) ..... \$179.00/kit  
 WS67WX29804 (HTP) (4 pc.) ..... \$119.00/kit  
 WS67WW11408 (Sedan) (8 pc.) ..... \$179.00/kit  
 WS67WW20604 (Sedan) (4 pc.) ..... \$119.00/kit

- 1967-69 Valiant & Valiant Signet**  
 WS67WX11108 (Conv.) (8 pc.) ..... \$179.00/kit  
 WS67WX21604 (Conv.) (4 pc.) ..... \$119.00/kit  
 WS67WX11208 (HTP) (8 pc.) ..... \$179.00/kit  
 WS67WX29804 (HTP) (4 pc.) ..... \$119.00/kit  
 WS67WW11408 (Sedan) (8 pc.) ..... \$179.00/kit  
 WS67WW20604 (Sedan) (4 pc.) ..... \$119.00/kit

- 1970-72 Dart**  
 WS70WX11208 (HTP) (8 pc.) ..... \$179.00/kit  
 WS70WX29804 (HTP) (4 pc.) ..... \$119.00/kit

- 1970-72 Valiant & Scamp**  
 WS70WX11208 (HTP) (8 pc.) ..... \$179.00/kit  
 WS70WX29804 (HTP) (4 pc.) ..... \$119.00/kit

- 1970-72 Duster**  
**1971-72 Demon**  
 WS70WX19004 (Fastback) (4 pc.).... \$119.00/kit  
 WS70WX20002 (Fastback) (2 pc.).... \$ 99.00/kit

- 1973-76 Duster & Dart Sport**  
 WS73WX19204 (Fastback) (4 pc.).... \$119.00/kit

E-BODY MODELS

- 1970 Challenger**  
 WS70WX19208 (Conv.) (8 pc.) ..... \$179.00/kit  
 WS70WX21304 (Conv.) (4 pc.) ..... \$119.00/kit  
 WS70WX19708 (HTP) (8 pc.) ..... \$179.00/kit  
 WS70WX21004 (HTP) (4 pc.) ..... \$119.00/kit

- 1970 Barracuda**  
 WS70WX19308 (Conv.) (8 pc.) ..... \$179.00/kit  
 WS70WX21404 (Conv.) (4 pc.) ..... \$119.00/kit  
 WS70WX11608 (HTP) (8 pc.) ..... \$179.00/kit  
 WS70WX21204 (HTP) (4 pc.) ..... \$119.00/kit

- 1971 Challenger**  
 WS71WX19408 (Conv.) (8 pc.) ..... \$179.00/kit  
 WS71WX21504 (Conv.) (4 pc.) ..... \$119.00/kit  
 WS71WX19808 (HTP) (8 pc.) ..... \$179.00/kit  
 WS71WX21104 (HTP) (4 pc.) ..... \$119.00/kit

- 1971 Barracuda**  
 WS71WX19408 (Conv.) (8 pc.) ..... \$179.00/kit  
 WS71WX21504 (Conv.) (4 pc.) ..... \$119.00/kit  
 WS71WX15108 (HTP) (8 pc.) ..... \$179.00/kit  
 WS71WX21304 (HTP) (4 pc.) ..... \$119.00/kit

- 1972-74 Challenger**  
 WS71WX19808 (HTP) (8 pc.) ..... \$179.00/kit  
 WS71WX21104 (HTP) (4 pc.) ..... \$119.00/kit

- 1972-74 Barracuda**  
 WS71WX15108 (HTP) (8 pc.) ..... \$179.00/kit  
 WS71WX21304 (HTP) (4 pc.) ..... \$119.00/kit

DODGE TRUCK MODELS

- 1973-79 Warlock & Lil' Red Express**  
 WS76WX15504 (4 pc.) ..... \$119.00/kit

# ORDERING INFORMATION

## HOW TO ORDER

**MAIL, PHONE OR FAXES** – When ordering by mail, please fill in all information on the order form that pertains to your vehicle. Print all information and include a telephone number where you can be reached during the day and evening. When ordering for more than one vehicle, please use separate order forms for each vehicle (see order forms in your Legendary Auto Interiors catalog). When ordering by phone, please have your customer number and a list of items ready. You may order conveniently by phone 8:00AM to 6:00PM EST Monday-Friday. Orders may also be sent in by fax 24 hours a day, 7 days a week. Please note that orders faxed in on Saturday or Sunday will not be received and processed until Monday. FAX: 1-800-732-8874

**ON-LINE ORDERING** – Legendary Auto Interiors, Ltd also offers convenient and easy on-line ordering 24 hours a day, 7 days a week at [www.legendaryautointeriors.com](http://www.legendaryautointeriors.com). Click on the “Shop Online” tab in the options menu and follow the ordering procedures. Upon completion, Legendary Auto Interiors, Ltd will follow up with an email confirmation so you can verify that your order has been received correctly and is being processed. You may also choose to email your orders by contacting our sales department at [sales@legendaryautointeriors.com](mailto:sales@legendaryautointeriors.com).

## METHODS OF PAYMENT

**CREDIT CARDS** – Legendary Auto Interiors, Ltd accepts Visa, MasterCard, American Express and Discover for your convenience. Please include the cardholder’s name, billing address, home and business phone, credit card number, expiration date and the 3 or 4 digit security code when placing your orders. Without this information it may slow the processing of your order.

**CHECKS AND MONEY ORDERS** – Personal Checks will be held 5 business days. To expedite your orders, we suggest paying by Certified Bank Check or Money Order. COD orders are no longer accepted. All payments MUST be in U.S. funds.

## SHIPPING SERVICES

**DOMESTIC SHIPPING** - Legendary Auto Interiors Ltd utilizes both UPS and FedEx Ground for most U.S. parcel shipments which provides our customers the most efficient and cost effective shipping services available. We will ship by the best method for your geographic area unless otherwise specified. We also offer specialized shipping services such as 3 day Select, 2nd day air and Next Day Air for your convenience.

**INTERNATIONAL SERVICES** – We use the most current and most cost effective international parcel shipping companies available to provide both “Door to Airport” and “Door to Door” services to our overseas customers. We utilize UPS Canadian and FedEx International for Canadian shipments. This provides us with the best possible shipping and brokerage fees for our international customers.

## DAMAGES AND SHORTAGES

The carrier is responsible for any merchandise lost or damaged in transit. **Should a package appear to be damaged, OPEN the package while the carrier’s driver is present and note all damages and/or shortages.** If this is not possible and you discover damaged goods or shortages, contact our Customer Service Department immediately! Damages and/or shortage claims must be made within 5 days of receipt of merchandise to ensure our ability to file a claim with the carrier. Please be sure to check all merchandise when you receive it and again before attempting installation.

Legendary Auto Interiors, Ltd. is committed to providing the highest possible level of customer service, however on rare occasions circumstances beyond our control can result in lost or damaged packages. To protect our customers against delays and having to make time consuming phone calls to the carrier, orders will incur a modest \$2.50 insurance fee on each shipment. In the event any products become lost or damaged we will then send replacement parts as quickly as possible, subject to material availability. We will also file the claims and deal with the carrier.

Carriers allow a short period of time to file claims. To take advantage of this service you must notify Legendary Auto Interiors, Ltd. of any damages within 5 days of receiving your delivery. Failure to contact us within this 5 day window will negate Legendary Auto Interiors further involvement.

## RETURN POLICY

Legendary Auto Interiors Ltd. will accept the return of products for a full refund or exchange up to 30 days from the original invoice date with no re-stocking fee. Returns after a 30 day period, but before 60 days will be subject to a 25% restocking fee. No returns will be accepted after 60 days. Custom, Special Orders, Specialty Run Materials, Leather, NOS and carpets ordered in colors other than black are not eligible for return under any circumstances other than a manufacturing defect. If any product is modified, altered, painted, installed or disassembled in any way without Legendary’s expressed written permission, the item is non-returnable. Legendary always recommends professional installation on all products. Any item which has been altered, painted, installed or deemed non-resalable by Legendary will be returned to the customer at the customer’s expense. Legendary is not responsible or liable for labor fees associated with the installation, modification or repair of any product purchased regardless of the circumstances.

## RETURN GOOD INFORMATION

All returns must receive prior approval and an RMA (Return Merchandise Authorization) number prior to return shipping. Packages received by Legendary Auto Interiors Ltd. without prior approval and RMA number will be refused. Return shipping and insurance are the customers responsibility. All returned items must be received in as new condition. Examples that render a product non-returnable include, but are not limited to: evidence of attempted installation, parts that have been bent, broken, creased, scratched, soiled, melted or discolored. Also, we will not accept returns for any items that have been altered, painted, repaired or for any reason that has rendered the product non-returnable. Warning: Legendary is not responsible for damaged or lost packages returned by the customer.

## CANADIAN CUSTOMER RETURNS

Warranty returns must be clearly marked as follows: **“U.S. GOODS BEING RETURNED FOR REPAIR OR REPLACEMENT UNDER WARRANTY COMMODITY CODE 9801:00V0”**.

## PRICES

All prices effective December 31st, 2021 and are subject to change without notice.

## HOURS

Monday – Friday 8:00AM to 6:00PM (Eastern Standard Time)

Saturday - By appointment only please

# IMPORTANT ADDITIONAL INFORMATION

## WARRANTY INFORMATION

Legendary Auto Interiors, Ltd proudly stands behind all of the products and services we offer. All Legendary manufactured interior soft trim products are backed by an exclusive **Limited Lifetime Warranty** for as long as you own your car. In addition, we offer a 5-year warranty on all of our molded and exterior soft trim products. Legendary Auto Interiors, Ltd also offers a huge selection of interior components, which we warranty for a minimum of 1 year in accordance with the original manufacturers product warranty. **Product Disclaimer: Normal wear from use or problems due to improper installation are excluded from any warranty.**

## LEGENDARY GUARANTEE

All Legendary Auto Interiors, Ltd manufactured products are made to original specifications and are guaranteed to fit. In the event that you experience a problem with any of our products or are dissatisfied with our service, we will make every effort to resolve and correct your issue promptly and do our best to make sure that you are completely satisfied.

## INTERIOR COLORS/GRAINS

Legendary Auto Interiors, Ltd offers one of the most diverse product lines available in the marketplace. We feature the correct “color matched” and “grain matching” materials for nearly all models and styles. Due to the extensive number of colors produced by Chrysler, AMC and General Motors, there are some colors, which are simply not available in reproduction form. As the demand for colors increases, we are constantly having previously unavailable colors reproduced. In the event that a vinyl or cloth is not available in reproduction form, the use of NOS material may be required. Please inquire for a current quote, as the price and availability of these NOS materials will vary. To ensure a correct color and grain match, your interior trim code may be required for verification. As color dye lots will vary, we recommend purchasing all your soft trim components at the same time to ensure an exact color match of all components throughout your interior. **Color and grain samples are available upon request at no charge.**

## LEATHER INTERIORS

Legendary Auto Interiors, Ltd produces a large number of “as original” leather interiors that are color matched to the original. Special order custom leather interiors are also available upon request. Some applications may require a clean, non-faded sample to ensure the closest possible color match. Leather interior orders may require additional lead-time as well as additional costs, which will be quoted at time of your order. **Note: Due to the variable nature of real leather, minor marks and features are normal and add to the character & individuality of leather products.**

## CUSTOM ORDERS

In addition to “As Original” reproduction interiors, Legendary Auto Interiors, Ltd specializes in and is proud to feature “CUSTOM” interiors servicing the Resto-Mod enthusiast. With the introduction of our new & exclusive *Legend/Interior* product, custom orders have taken on an entirely new look and have given enthusiasts almost limitless options to create a one of a kind interior. Special Order and Custom interiors require approval for all designated materials being used and a signature approval on a “Custom Order” form is also required. Once the Custom work has been approved these orders must be prepaid and are Non-Returnable, Non-Refundable and Non-Cancelable.

## INSTALLATION NOTES

Since age deteriorates certain areas of seats due to wear patterns and foam breakdown, certain adjustments and foam repair may be required to complete a perfect fit installation. For this reason, we recommend having a professional automotive interior trim/upholstery shop install your new Legendary Auto Interiors, Ltd soft trim products. As the manufacturer, we know how to install our products better than anyone and we offer complete installation services for both seat upholstery and door panels. For further information, see the **INSTALLATION GUIDE** included with your seat upholstery and door panels or the installation page of this catalog.

## PRODUCT DEVELOPMENT & PATTERNS NEEDED

In an effort to develop new upholstery kits, door panels and other soft trim products we work hand in hand with many of our customers who provide their original parts for product development. These items must be ORIGINAL, in fair to good condition and have not been previously repaired or replaced in any way. Our Sales Department must be contacted directly before sending your old upholstery or other soft trim products to us. Since we have no idea about the usability of your parts until we receive them in, you may initially be asked to send photos in an effort to identify the condition of your original parts. Please remember that even if you send in your parts for inspection, we may not be able to use them. **PLEASE NOTE THAT OLD UPHOLSTERY AND OTHER SOFT TRIM ITEMS CANNOT BE RETURNED TO YOU, AS THEY WILL BE DISMANTLED FOR DEVELOPMENT USE.**

## MAINTENANCE

All Legendary Auto Interiors, Ltd products may be cleaned with a mild soap and warm water solution. Never scrub or use any kind of harsh pads, brushes or detergents. After cleaning with mild soap and water, lightly clean again with an industrial grade wax and grease remover. (Contact your local auto parts store) Allow surface to dry. LIGHTLY mist with the vinyl protectant of your choice. Install your new parts into your cruising machine. Sit back, enjoy the ride and drive safely!! Note: On leather upholstery applications we recommend using a high-quality mink oil, neatsfoot oil and/or wax. Hand apply, let stand 30-60 minutes and then wipe /buff clean. LIGHTLY rub your soft trim product with oil and wipe excess oil from the surface. **DO NOT USE SILICONE BASED PRODUCTS** as they will deteriorate the thread and dry out leather.

# INSTALLATION SERVICES

## GM, CHRYSLER & AMC SEAT UPHOLSTERY

*(Includes tear down of original upholstery and installation of new upholstery)*



Front Buckets Install - \$500.00/pr.  
(No Headrest Covers)



Front Buckets w/ Headrest Covers Install - \$600.00/pr.



Front Split Bench Install - \$575.00/ea.



Front Split Bench w/ Headrest Covers Install - \$675.00/ea.



Rear Bench Seat Install - \$400.00/ea.



Headrest Covers Install - \$150.00/pr.

Center Armrest Install - \$150.00/ea.  
(for models w/ buckets and no console)



## SAVE ON COMPLETE FRONT & REAR INSTALLS!!

Front Buckets & Rear Bench Seat Install - \$750.00/set

Front Buckets w/ Headrest Covers & Rear Bench Seat Install - \$850.00/set

Front Split Bench & Rear Bench Seat Install - \$825.00/set

Front Split Bench w/ Headrest Covers & Rear Bench Seat Install - \$925.00/set

*\*NOTE\* Basic installations DO NOT include new foam and cotton replacement or reconstruction, media blasting, painting, welding, frame straightening, polishing or trim detailing. These services are additional and available at an hourly rate. Please call for more details. 1-800-363-8804*

# INSTALLATION SERVICES

## GM, CHRYSLER & AMC DOOR PANELS

### Basic Door Panel Installation

*(Includes installation of metal rails and window weatherstrip)*

*\*Convertible rear panel installation DOES NOT include ashtray/well covers*

*\*Ashtray/well covers for General Motors models are available. Call for details*



Front Panels (Pair Only) - \$250.00/pr.



Hardtop/Convertible Rear Panels (Pair Only) - \$250.00/pr.

**Complete Front & Rear Panels (Pairs Only) - \$500.00/pr.**

### Deluxe Door Panel Installation

*(Includes installation of metal rails, window weatherstrip, metal trim and decorative emblems)*

*\*Convertible rear panel installation DOES NOT include ashtray/well covers*

*\*Ashtray/well covers for General Motors models are available. Call for details*



Front Panels (Pair Only) - \$400.00/pr.



Hardtop/Convertible Rear Panels (Pair Only) - \$325.00/pr.

**Complete Front & Rear Panels (Pairs Only) - \$725.00/pr.**

## DOOR PANEL REFURBISHMENT

*If we do not list your particular year/make/model vehicle, Legendary Auto Interiors, Ltd. can refurbish your panels back to original for you. The following refurbishing rates include installation of new panels (on your original metal rails), inner window weatherstripping, metal trim and decorative emblems. Please call for instructions before shipping your door panels.*

Front Panels (Pair Only) - \$750.00/pr.

Hardtop/Convertible Rear Panels (Pair Only) - \$500.00/pr.

Complete 2-Door Front & Rear Panels (Pairs Only) - \$1250.00/set

Complete 4-Door Front & Rear Panels (Pairs Only) - \$1250.00/set

*\*NOTE\* Custom refurbishing does not include the refinishing of metal trim and decorative emblems. We highly recommend this work is done before sending the panels.*

# SHIPPING/HANDLING RATE CHART

<u>Order Value \$</u>	<u>Flat Rate</u>	<u>Oversize Charges</u>	<u>Rate</u>
.01-40	\$10	OS1	\$25
41-100	\$22	OS2	\$49
101-200	*\$32	OS3	\$71
201-400	*\$41		
401-600	*\$47		
601-800	*\$74		
801-1000	*\$108		
1001-1250	*\$157		
1251-1500	*\$164		
1501-1850	*\$206		
1851-2100	*\$247		
2101-2500	*\$282		
2501-2999	*\$318		
3000-up	*\$352		

\*On all orders over \$100

\*NYS Customers - Sales tax will be added

\*AK, HI, PR & International customers call for shipping

\*Next Day, 2nd Day & 3 Day Select shipping, please call for rates

\*Includes \$3.50 for insurance

## Oversize Items      Classification

Package Tray	OS1
Trunk Divider	OS1
Plastic Door Panels	OS1
Pre-Assembled Door Panels	OS1
2nd Gen F-Body Door Panels	OS1 
Consoles	OS1
Bucket Molded Foam	OS1
Install Kits 2-5, 12-15	OS1
Vinyl Yardage (1yd & up)	OS1

## Oversize Items      Classification

Molded Headliners	OS3
Molded Hood Pads	OS3
Pick Up Seat Back Kits	OS3 
GM Bench Seat Foam	OS3 
E-Body Dash Pads/Caps	OS3
Trunk Packages	OS3

## Oversize Items      Classification

C-Body Carpet Kits	OS2
62-65 B Body Mopar Carpet Kits	OS2
64-69 Cuda Fastback Carpet Kits	OS2
66-67 Charger Fastback Carpet Kits	OS2 
Carpet Yardage	OS2
Sound Dampeners	OS2
Firewall Insulation	OS
Convertible Glass	OS2

# 2024 TENTATIVE SHOWS AND DATES

*Spring Carlisle  
Chryslers @ Carlisle  
Fall Carlisle  
SEMA*

*Carlisle, PA  
Carlisle, PA  
Carlisle, PA  
Las Vegas, NV*

*April 17 - 21, 2024  
July 12 - 14, 2024  
October 2 - 6, 2024  
November 5-8, 2024*

Due to the ongoing COVID-19 pandemic the above dates are tentative and are subject to being changed or cancelled. For updates please check our website at [www.legendaryautointeriors.com](http://www.legendaryautointeriors.com) or call us at 1-800-363-8804.

**Legendary Auto Interiors Ltd. welcomes the opportunity to support the smaller clubs' and organizations' car shows and swap meets. A variety of flyers, catalogs and gift certificates are available to clubs and organizations who sponsor shows nationwide. Please call or write for additional information. The list above is a tentative schedule subject to change without notice. Come visit us at many car shows/swap meets and see what makes a Legendary interior... truly Legendary.**



**Legendary**  
**AUTO INTERIORS LTD.**



## Table of Contents

### **SEAT UPHOLSTERY & TRIM ACCESORIES A1-A35**

Bucket Seat Catch.....	A34	Upholstery (Barracuda (64-69).....	A18-A24
Bucket Seat Hinge Washer .....	A34	Upholstery (Challenger).....	A24-A27
Headrest Chrome Bands.....	A35	Upholstery (Cuda (70-74).....	A23-A27
Hinge Covers.....	A34	Upholstery (Dart).....	A2-A17
Front Shoulder Harness .....	A35	Upholstery (Demon).....	A12, A14-A16
Plastic Seatback Covers.....	A34	Upholstery (Duster).....	A12-A17
Seat Belts.....	A34	Upholstery (Gran Coupe).....	A22-A24
Seat Belt Guide .....	A35	Upholstery (Scamp).....	A5, A9-A11
Seat Belt Mounting Covers.....	A35	Upholstery (Superstock).....	A29-A30
Seat Spacer.....	A34	Upholstery (Truck).....	A30-A32
Seat Spring Kits.....	A33	Upholstery (Valiant).....	A2-A4, A6-A7, A11
Seat Stops.....	A34	Upholstery (Volare).....	A28
Seatback Boards.....	A35	Upholstery (Van).....	A29
Seatback Top Boards .....	A35		

### **MOLDED FOAM & FOAM ACCESORIES A36-A40**

Cotton Rolls.....	A37
High Density Foam.....	A37
Hog Ring Plier Kits .....	A37
Molded Foam.....	A38-A40
Seat Upholstery Installation Kits.....	A36

### **DOOR PANELS & TRIM ACCESORIES A41-A59**

Armrest Bases.....	A58	Door Panels (Barracuda (64-69).....	A53-A54
Armrest Pads.....	A58	Door Panels (Challenger).....	A55
Ash Trays.....	A59	Door Panels (Cuda (70-74).....	A55
Door Handles.....	A59	Door Panels (Dart).....	A43-A52
Door Lock Ferrules.....	A58	Door Panels (Demon).....	A49-A50
Door Lock Knobs.....	A58	Door Panels (Duster).....	A49-A52
Door Panel Carpet Trim.....	A59	Door Panels (Gran Coupe).....	A55
Door Panel Clips.....	A58	Door Panels (Scamp).....	A46-A48
Door Panel Emblems.....	A59	Door Panels (Superstock).....	A56
Door Panel Woodgrain .....	A59	Door Panels (Valiant).....	A44
Vent Window Cranks .....	A59		
Window Cranks .....	A59		
Window Crank Screws .....	A59		
Window Crank Spacers.....	A59		

### **CARPETS, FLOORMATS & ACCESORIES A61-A82**

Carpet.....	A65-A66	Jute Backing.....	A66
Carpet Yardage.....	A66	Kick Panels.....	A82
Firewall Insulation.....	A82	Kick Panel Insulation .....	A82
Floormats ("Custom Vintage").....	A71-A74	Sill Plates.....	A82
Floormats (Original).....	A75	Sound Dampening.....	A82
Floormats (Next Generation).....	A76-A77	Sound Deadener .....	A82

### **DASHES, CONSOLES, SHIFTERS & ACCESORIES A83-A86**

Choke Applique .....	A84	Glove Box Liners .....	A86	"Shaker" Under Dash Cable .....	A84
Consoles.....	A85	HEMI Choke Cable.....	A84	"Shaker" Under Hood Cable.....	A84
Console Carpet Kits.....	A85	Horn Button .....	A85	Shifter Bezels .....	A86
Console Shifter Slide .....	A85	Light Lenses.....	A85	Shifter Boots.....	A86
Dash Caps.....	A84	Pedal Pads .....	A86	Shifter Knobs.....	A86
Dash Pads.....	A84	Pedal Pad Bezels .....	A86	Underdash Insulation.....	A84
Dash Pad Emblems.....	A84	Pillar Post Moldings .....	A84	Vent Cables .....	A84
Dash Pad Speaker Grill.....	A84	Pistol Grip Shifter & Lens .....	A86	Woodgrain Console Inserts .....	A85
Dash Vents.....	A85			Woodgrain Dash Inserts .....	A85
Dash Vent Hose Kits.....	A85				

# Table of Contents

## **HEADLINERS & TRIM ACCESORIES A87-A94**

Foam Backed Cloth Headliner.....	A90
Foam Backed Sail Panel Boards.....	A91
Foam Backed Sunvisors.....	A94
Headliners .....	A89-A90
Headliner Bow Retaining Clips .....	A90
Headliner Insulation.....	A90
Plastic Headliners.....	A90
Sail Panels.....	A91
Sunvisors.....	A93-A94
Sunvisor Tips.....	A94

## **PACKAGE TRAY & TRUNK ACCESORIES A95-A100**

Package Trays & Jute Insulation .....	A96-A98
Spare Tire Board .....	A100
Spare Tire Cover .....	A100
Trunk Dividers & Insulation.....	A100
Trunk Mats.....	A99-A100
Trunk Mat Material.....	A100
Trunk Side Panel Covers.....	A100

## **VINYL TOPS, CONVERTIBLE TOPS & TRIM A101-A111**

Anti Rattle Plates.....	A108
Convertible Body Screw Studs .....	A111
Convertible Boots .....	A110
Convertible Boot Clips.....	A110
Convertible Tops.....	A108
Convertible Top Latch.....	A111
Convertible Top Pads .....	A108
Convertible Well Liners.....	A111
Vinyl Tops .....	A104-A105

## **WEATHERSTRIPPING & ACCESORIES A113-A119**

Accelerator Gaskets .....	A114	Door Weatherstripping.....	A116	Rear Quarter Window Seals.....	A117
Body Bumper Kits.....	A114	Door Windlace Weatherstripping.....	A116	Rear Window Gaskets.....	A115
Body Plug Kits .....	A114	Door Weatherstripping Clips.....	A116	Roof Rail Weatherstripping.....	A117
Conv. Top Frame Weatherstripping .....	A117	Header Seals .....	A117	Trunk Bumper Kits.....	A114
Door End Seals .....	A116	Hood Bumper .....	A114	Trunk Seals .....	A117
Door End/Lock Seal Screw.....	A116	Hood Bumper Kits .....	A114	Vent Channel Weatherstripping.....	A117
Door Handle Gaskets .....	A115	Hood Pad Clips.....	A118	Vent Window Seal .....	A117
Door Lock Seals .....	A116	Hood Pad Insulation.....	A118	Window Sweep Kits.....	A119
Door & Trunk Lock Gaskets.....	A115	Hood-to-Cowl Seals.....	A118	Window Trim Clips.....	A115
		Hood-to-Radiator Seals .....	A118	Windshield Gaskets.....	A115
		Molded Hood Pad.....	A118		

Legendary Auto Interiors, Ltd.  
121 West Shore Blvd  
Newark, NY 14513



 [twitter.com/legendaryautoin](https://twitter.com/legendaryautoin)

 [youtube.com/user/legendaryauto](https://youtube.com/user/legendaryauto)

 [facebook.com/legendaryautointeriors](https://facebook.com/legendaryautointeriors)

 [instagram.com/legendaryautointeriorsltd](https://instagram.com/legendaryautointeriorsltd)



**LEGENDARY AUTO INTERIORS**

**1-800-363-8804**

**WWW.LEGENDARYAUTOINTERIORS.COM**