

# Legendary

**AUTO INTERIORS LTD.**



# BUICK

**1964-72 SKYLARK, GSX  
& GRAN SPORT**

2026 Second Quarter



[www.legendaryautointeriors.com](http://www.legendaryautointeriors.com)





# WE'RE NOT JUST CHRYSLER ANYMORE!

1964-72 CHEVELLE/EL CAMINO, GTO/LEMANS, CUTLASS/442 & SKYLARK/GS  
1970-72 MONTE CARLO, 1970-72 NOVA & 1967-81 CAMARO & FIREBIRD

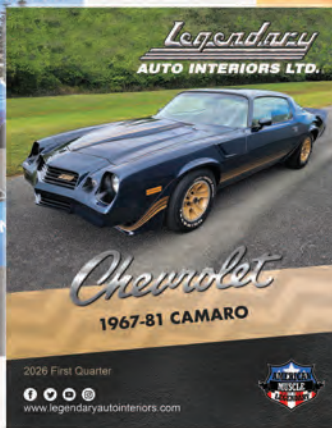

WWW.LEGENDARYAUTOINTERIORS.COM

# A Special Message from the President...

For over 4 decades, Legendary Auto Interiors, Ltd has been committed to providing the automotive restoration industry and enthusiast with the world's highest quality soft trim products and services. Available from the most authentic "As Original" interiors to the most extreme "One of a Kind" Custom Resto-Mod interiors, Legendary has been relied upon and Legendary has delivered!

This past decade has been extremely exciting! We continue to set the bar and truly lead by example, establishing industry expectations and standards. Introducing innovative tools such as our exclusive "Custom Design Center", "LegendImagery™" and "Sample Request Center". Whether your preference is "As Original" or a creation of your own vision, we have created a destination where you can let your imagination lead the way! Our commitment to developing and maintaining innovative solutions is a dedicated process that will continue to provide you with great products, service and help grow our restoration industry.

We are looking forward to a very productive future. As owner and President and from all of our proud team here at Legendary Auto Interiors LTD, we would like to thank you for allowing us the opportunity and the privilege of being your automotive soft trim supplier.

Thank you once again for your business, interest and support!

Sincerely yours,

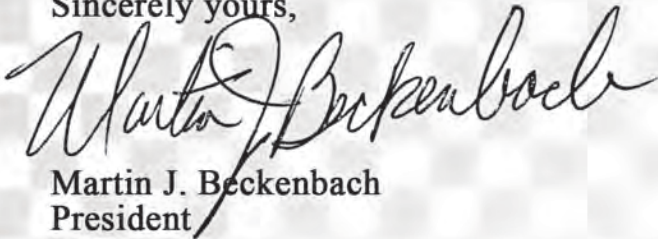

Martin J. Beckenbach  
President

PRODUCT DISCLAIMER: Products listed in this catalog have been reproduced and/or remanufactured to resemble original products. All manufacturers names and descriptions are used for reference purposes only. It is therefore understood that the products listed in this catalog are in fact REPRODUCTIONS unless specified otherwise. All parts described and offered for sale in this publication as NOS (New Old Stock) are new parts/materials manufactured by or for Chrysler LLC and General Motors Corporation.

All literature produced by and directly related to Legendary Auto Interiors Ltd., is protected under copyright laws.  
All literature cannot be reproduced for any reason unless prior permission is obtained.



# FLEX TREAD®

YOU ASK FOR IT...WE DELIVERED!!



YOU ASK FOR IT...WE DELIVERED!!



\*\*\*

Flextread is providing the most innovative  
molded floormats in the industry  
RIGHT HERE AT HOME!  
All products are 100% assembled, designed  
and made in the U.S.A.

\*\*\*



\*\*\*

THE NEXT GENERATION IN FLOORMATS

\*\*\*

**FLEXTREAD®**

# BOOTMAT COLORS



001 - Black



007 - Dark Blue



011 - Medium Blue



018 - Bright Red



020 - Red



051 - Lime Green



023 - Tan



031 - Maroon



050 - Turquoise



054 - Purple



057 - Dark Olive Green



074 - Pink



079 - Grey



098 - Brown



129 - Dark Saddle



132 - Gold

## CAMOUFLAGE



200 - Rugged Woods



202 - Cyberflage



PATENTED

# SCENERY BOOT MATS

MANY KOOL SCENES  
AVAILABLE AND  
MORE COMING SOON!



DUCK SCENE



BEAR SCENE

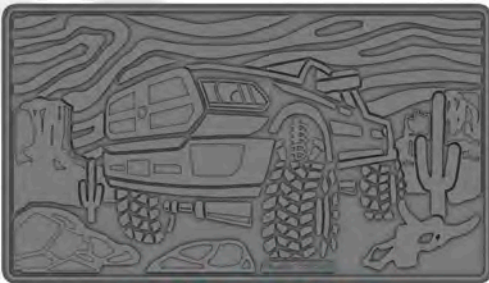

4X4 SCENE



TURKEY SCENE



FISHING SCENE



WHITETAIL SCENE



EQUINE SCENE



SCORCHED EARTH &  
TIRE TRACK SCENE



TREE SCENE

# FLEXTREAD®

1-833-700-3539 EXT. 222  
WWW.FLEXTREADMATS.COM



\*\*\*

Providing the automotive industry  
with the world's highest quality  
soft trim products and services  
RIGHT HERE AT HOME

\*\*\*

STILL ASSEMBLED AND  
MADE IN THE ★★★★★  
**USA** 

\*\*\*

THERE REALLY IS A DIFFERENCE!!

\*\*\*

*Legendary*  
**AUTO INTERIORS LTD.**

[www.legendaryautointeriors.com](http://www.legendaryautointeriors.com)



# INTRODUCING THE BEST WARRANTY COVERAGE IN THE INDUSTRY!!

## Limited Lifetime Warranty

**Limited Warranty** - Legendary Auto Interiors Ltd. (called "we") warrants that the products it manufactures will be free of defects in materials and workmanship from the date it is first purchased by the retail purchaser. A retail purchaser is any person or any entity who or which purchases the product but does not do so for resale.

**Warranty Information** - Legendary Auto Interiors, Ltd proudly stands behind all of the products and services we offer. All Legendary manufactured sewn interior soft trim products are backed by an exclusive Limited Lifetime Warranty for as long as you own your car. In addition, we offer a 5-year warranty on all of our molded, die-electrically heat sealed and exterior soft trim products. Legendary Auto Interiors, Ltd also offers a huge selection of interior components, which we warranty for a maximum of 1 year in accordance with the original manufacturers product warranty.

**Obligation** - If a product is not as warranted, we will either repair or, at our option, replace the defective product. If repair or replacement is not possible within a reasonable time, we will refund the purchase price.

**Exclusions from Warranty** - This Warranty does not apply to:

1. Conditions resulting from the product being altered, abused, misused, damaged by accident or negligence; being repaired without our authorization; or not being maintained properly in accordance with written instructions provided with the product.
2. Conditions resulting from ordinary wear and tear or including, without limitation, exposure to ultraviolet light.
3. Conditions resulting from the use of Specialty Run Materials (SRM) supplied by the purchaser.
4. Conditions resulting from improper installation by the purchaser or anyone else outside of our control.

**Disclaimer** - EXCEPT FOR THE LIMITED WARRANTY DESCRIBED ABOVE, WE OFFER NO WARRANTIES, EXPRESSED OR IMPLIED, AND OTHER THAN THE LIMITED WARRANTY EXPRESSLY CONTAINED HEREIN, WE HEREBY DISCLAIM ANY AND ALL WARRANTIES, INCLUDING WITHOUT LIMITATION ANY IMPLIED WARRANTIES OF MERCHANTABILITY, SUITABILITY OR FITNESS FOR A PARTICULAR PURPOSE. Some states do not allow limitations on how long an implied warranty lasts, so the above limitation may not apply to you.

**Exclusion of Incidental and Consequential Damages** - WE ARE NOT RESPONSIBLE FOR ANY INCIDENTAL OR CONSEQUENTIAL DAMAGES RESULTING FROM BREACH OF THE LIMITED WARRANTY DESCRIBED ABOVE. Some states do not allow the exclusion or limitation of incidental or consequential damages, so the above limitation or exclusion may not apply to you.

**Other Legal Rights** - This Warranty gives you specific legal rights, and you may also have other rights which vary from state to state.

**What To Do If You Have A Warranty Claim** - If you have a warranty claim, you must call our sales office for further assistance. Once given a return authorization number please indicate the number on the box and return the product to our facility; Legendary Auto Interiors 121 West Shore Blvd, Newark, NY 14513. We will perform our warranty obligation within a reasonable amount of time after the returned product arrives at our facility.

Eff. 08/01/2024



**PRODUCT DISCLAIMER:** Products listed in this catalog have been reproduced and/or remanufactured to resemble original products. All manufacturers names and descriptions are used for reference purposes only. It is therefore understood that the products listed in this catalog are in fact REPRODUCTIONS unless specified otherwise. All parts described and offered for sale in this publication as NOS (New Old Stock) are new parts/materials manufactured by or for Chrysler Group LLC and General Motors Corporation.

LEGENDARY AUTO INTERIORS LTD., COPYRIGHT 2026

All literature produced by and directly related to Legendary Auto Interiors Ltd., is protected under copyright laws.  
All literature cannot be reproduced for any reason unless prior permission is obtained.

# Vinyl Grain Chart

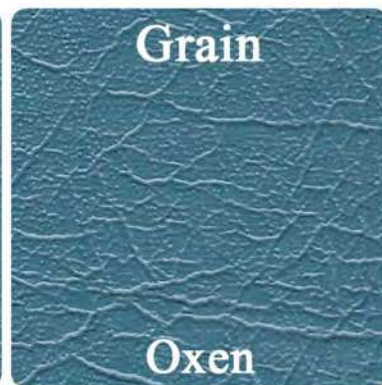
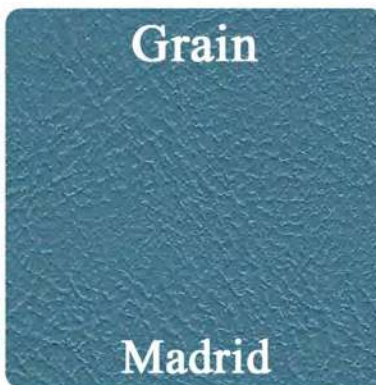
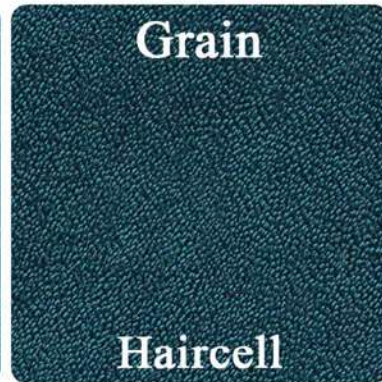
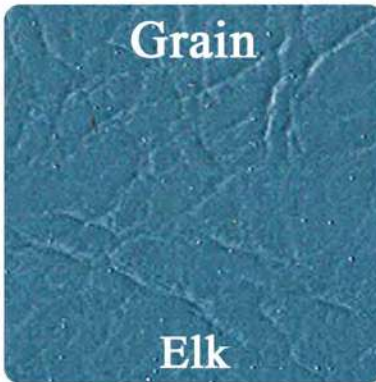
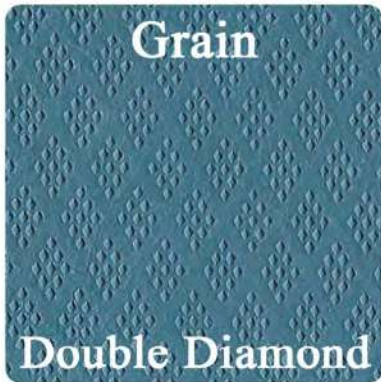
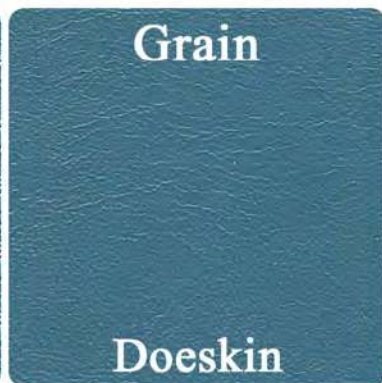
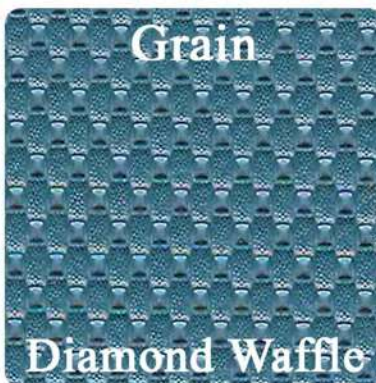
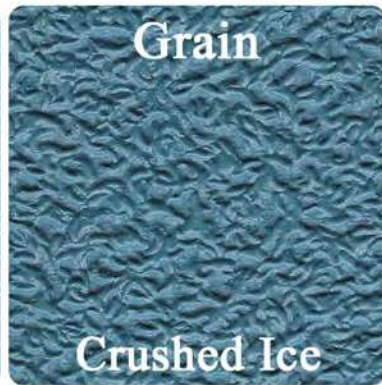

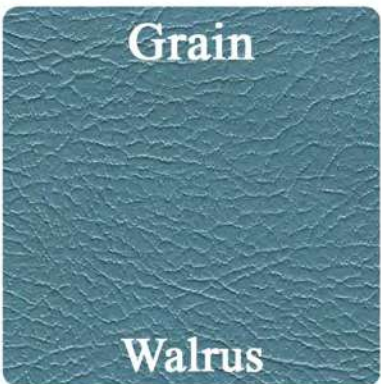
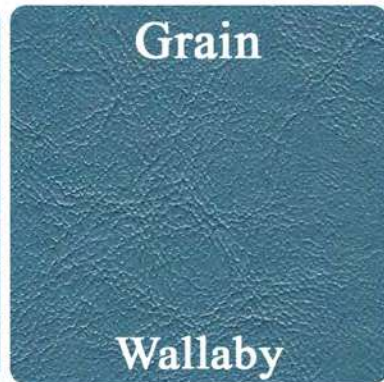
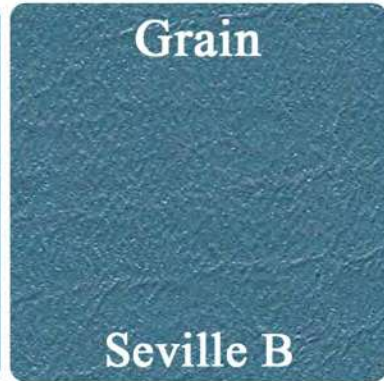
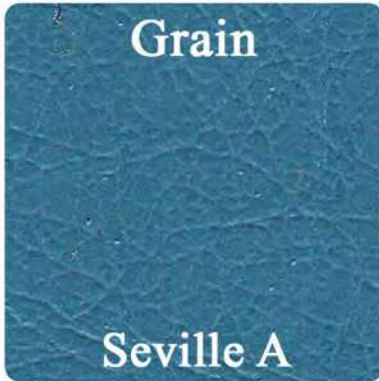
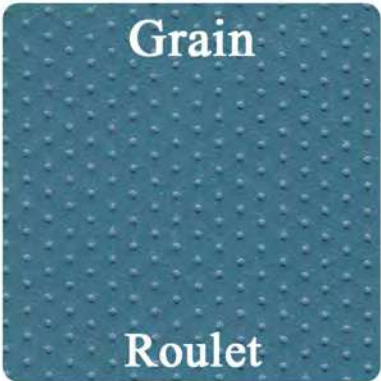
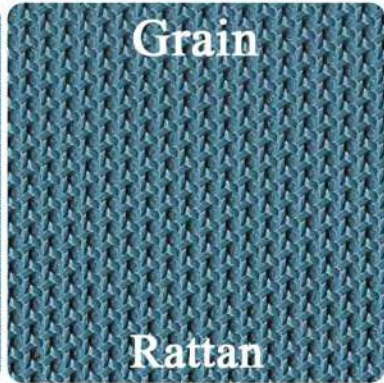
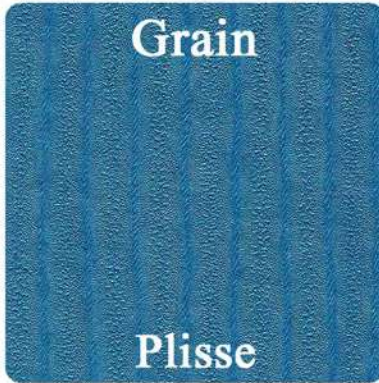

# Vinyl Grain Chart





# Vinyl Yardage

The following grains are available off the roll and come in 1/2 yard increments **ONLY**

**Ascot**  
 VVYDASCOT(C) (1 Yard).....\$64.00/yd.   
 VV1/2YDASCOT(C) (1/2 Yard).....\$32.00/ea.  
 Available colors: 100

**Bison**  
 VVYDBISON(C) (1 Yard).....\$64.00/yd.   
 VV1/2YDBISON(C) (1/2 Yard).....\$32.00/ea.  
 Available colors: 100, 204, 314, 510, 606, 610

**Coachman**  
 VVYDCOACHMAN(C) (1 Yard).....\$64.00/yd.   
 VV1/2YDCOACHMAN(C) (1/2 Yard).....\$32.00/ea.  
 Available colors: 100, 130, 140, 200, 330, 338,  
 340, 432, 434, 452, 528, 540, 550, 560, 640, 650,  
 656, 664, 666, 670

**Cologne**  
 VVYDCOLOGNE(C) (1 Yard).....\$64.00/yd.   
 VV1/2YDCOLOGNE(C) (1/2 Yard).....\$32.00/ea.  
 Available colors: 100, 102, 10A, 202, 318, 320,  
 332, 414, 420, 430, 520, 526, 614, 620, 636

**Doeskin**  
 VVYDDOESKIN(C) (1 Yard).....\$64.00/yd.   
 VV1/2YDDOESKIN(C) (1/2 Yard).....\$32.00/ea.  
 Available colors: 100, 104, 200, 206G, 508G

**Dorchester**  
 VVYDDORCHESTER(C) (1 Yard).....\$64.00/yd.   
 VV1/2YDDORCHESTER(C) (1/2 Yard).....\$32.00/ea.  
 Available colors: 100, 202

**El Paso**  
 VVYDELPASO(C) (1 Yard).....\$64.00/yd.   
 VV1/2YDELPASO(C) (1/2 Yard).....\$32.00/ea.  
 Available colors: 100, 200

**Krinkle**  
 VVYDKRINKLE(C) (1 Yard).....\$64.00/yd.   
 VV1/2YDKRINKLE(C) (1/2 Yard).....\$32.00/ea.  
 Available colors: 100, 154

**Madrid**  
 VVYDMADRID(C) (1 Yard).....\$64.00/yd.   
 VV1/2YDMADRID(C) (1/2 Yard).....\$32.00/ea.  
 Available colors: 100G, 202G, 204G, 210G, 220G,  
 230G, 235G, 239G, 240G, 310G, 325G, 331G, 333G,  
 334G, 338G, 342G, 343G, 351G, 369G, 380G, 415G,  
 420G, 421G, 424G, 429G, 448G, 460G, 465G, 469G,  
 501G, 511G, 513G, 520G, 631G, 635G, 640G, 642G,  
 645G, 650G, 651G, 657G, 658G, 670G, 679G, 683G,  
 690G, 694G, 695G, 697G, 709G, 710G

**Oxen**  
 VVYDOXEN(C) (1 Yard).....\$64.00/yd.   
 VV1/2YDOXEN(C) (1/2 Yard).....\$32.00/ea.  
 Available colors: 100

**Oxford**  
 VVYDOXFORD(C) (1 Yard).....\$64.00/yd.   
 VV1/2YDOXFORD(C) (1/2 Yard).....\$32.00/ea.  
 Available colors: 100, 200, 264, 360, 450

**Ranger**  
 VVYDRANGER(C) (1 Yard).....\$64.00/yd.   
 VV1/2YDRANGER(C) (1/2 Yard).....\$32.00/ea.  
 Available colors: 100, 200

**Shallow Elk**  
 VVYDSHALLOWELK(C) (1 Yard).....\$64.00/yd.   
 VV1/2YDSHALLOWELK(C) (1/2 Yard).....\$32.00/ea.  
 Available colors: 100, 156, 200, 202G, 230G, 341

**Sierra**  
 VVYDSIERRA(C) (1 Yard).....\$64.00/yd.   
 VV1/2YDSIERRA(C) (1/2 Yard).....\$32.00/ea.  
 Available colors: 100G, 102G, 200G, 209G, 319G,  
 528G, 684G, 688G

**1 YARD AND MORE IS SHIPPED OVERSIZED 1**

## Specialty Grain Vinyl Yardage



All grain/color combinations not listed above can be produced upon request.  
 Available in 1/2 yd or 1yd sheets **ONLY**



1/2 Yard (54"x18")  
 TTMOLDSMALL.....\$36.00/ea.  
 \* Need to specify grain and color

1 Yard (54"x36")  
 TTMOLDXL.....\$96.00/ea.   
 \* Need to specify grain and color



# UPHOLSTERY AND TRIM ACCESORIES

 [facebook.com/legendaryautointeriors](https://facebook.com/legendaryautointeriors)  
 [twitter.com/legendaryautoin](https://twitter.com/legendaryautoin)

 [www.legendaryautointeriors.com](http://www.legendaryautointeriors.com)  
 [instagram.com/legendaryautointeriorsltd](https://instagram.com/legendaryautointeriorsltd)  
 [youtube.com/user/legendaryauto](https://youtube.com/user/legendaryauto)

## 1964 SKYLARK



**(C) COLOR CODES:**

- (100G) Black
- (220G) Frost White
- (334G) Dark Metallic Blue
- (405G) Metallic Green
- (508G) Red
- (656G) Brown

*This Legendary product features as-original heat sealed Seville grain inserts and Seville grain skirts with buttons.*

- Front Buckets ..... **AA64GK00010(C)**  
 100G, 220G, 508G..... \$660/pr.  
 334G, 656G ..... \$693/pr. (L4)  
 405G ..... \$1283/pr. (L1)  
 ☞ Molded foam is available for this model.  
 Please see the "GM Molded Foam" section in this catalog.  
 ☞ 405G Metallic Green uses Special Run Material.

- Rear Bench  
 Sport Coupe ..... **AA64GK00048(C)**  
 Convertible ..... **AA64GK00056(C)**  
 100G, 220G, 508G .... \$376/ea.  
 334G, 656G ..... \$395/ea. (L4)  
 405G ..... \$1013/ea. (L1)  
 ☞ 334G Dark Metallic Blue was not offered on a bucket seat interior trim style for a Convertible model in 1964.  
 ☞ 405G Metallic Green uses Special Run Material.

- Convertible Rear Bench Back Panel  
 ..... **SK64GA00019(C)**  
 100G, 220G, 508G .... \$ 79/ea.  
 334G, 656G ..... \$ 83/ea. (L4)  
 405G ..... \$247/ea. (L1)  
 ☞ 405G Metallic Green uses Special Run Material.

## 1965 SKYLARK & GRAN SPORT

PHOTO N/A  
 AT TIME OF  
 PRINTING

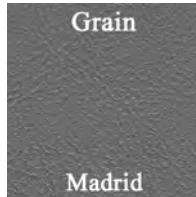

**(C) COLOR CODES:**

- (100G) Black
- (315G) Light Metallic Blue / Dark Metallic Blue
- (516G) Metallic Red / Dark Metallic Red
- (686G) Saddle / Metallic Brown

*This Legendary product features as-original Madrid grain inserts and Madrid grain skirts with buttons.*

- Front Buckets ..... **AA65GKN0010(C)**  
 100G, 315G, 516G..... \$597/pr.  
 686G..... \$1283/pr. (L1)  
 ☞ Molded foam is available for this model.  
 Please see the "GM Molded Foam" section in this catalog.  
 ☞ 686G Metallic Green uses Special Run Material.

- Rear Bench  
 Coupe ..... **AA65GKN0040(C)**  
 100G, 315G, 516G .... \$356/ea.  
 686G..... \$1013/ea. (L1)  
 ☞ 686G Metallic Green uses Special Run Material..

## 1965 SKYLARK & GRAN SPORT

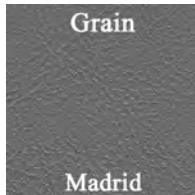

**(C) COLOR CODES:**

- (100G) Black
- (220G) Frost White
- (343G) Dark Metallic Blue
- (520G) Metallic Red
- (679G) Saddle

*This Legendary product features as-original Madrid grain inserts and Madrid grain skirts with buttons.*

- Front Buckets ..... **AA65GK00010(C)**  
 100G, 220G,  
 343G, 520G..... \$660/pr.  
 679G..... \$1283/pr. (L1)  
 ☞ Molded foam is available for this model.  
 Please see the "GM Molded Foam" section in this catalog.

- Rear Bench  
 Sport Coupe ..... **AA65GK00040(C)**  
 Convertible ..... **AA65GK00056(C)**  
 100G, 220G  
 343G, 520G ..... \$376/ea.  
 679G..... \$1013/ea. (L1)  
 ☞ 100G Black was not offered on a bucket seat interior trim style for a Sport Coupe model in 1965.  
 ☞ 343G Dark Metallic Blue was not offered on a bucket seat interior trim style for a Convertible model in 1965.

- Convertible Rear Bench Back Panel  
 ..... **SK65GA00019(C)**  
 100G, 220G, 343G, 520G ..... \$79/ea.  
 679G..... \$247/ea.



## 1966 SKYLARK & GRAN SPORT "OEM STYLE"



**(C) COLOR CODES:**

- (100G) Black
- (240G) Metallic Parchment
- (330G) Light Metallic Blue w/ Dark Metallic Blue Accent
- (518G) Metallic Red w/ Dark Metallic Red Accent

Front Buckets ..... **AA66GK00010(C)**  
 100G, 330G, 518G..... \$574/pr.  
 240G..... \$603/pr. (L4)  
 ☞ Molded foam is available for this model. Please see the "GM Molded Foam" section in this catalog.

Rear Bench  
 Coupe & Sport Coupe ..... **AA66GK00048(C)**  
 Convertible ..... **AA66GK00056(C)**  
 100G, 330G, 518G ..... \$323/ea.  
 240G..... \$339/ea. (L4)  
 ☞ 518G Metallic Red w/ Dark Metallic Red accents was not offered on a bucket seat interior trim style for a Coupe model in 1966.

Headrest Covers..... **HC66GA00N14(C)**  
 100G, 330G, 518G ..... \$82/pr.  
 240G..... \$86/pr. (L4)  
 ☞ Non-original replacement covers for factory molded headrests.  
 ☞ Professional installation is highly recommended.

Convertible Rear Bench Back Panel  
 ..... **SK65GA00019(C)**  
 100G, 330G, 518G ..... \$79/ea.  
 240G..... \$83/ea. (L4)

This Legendary product features as-original heat sealed Madrid grain inserts and Madrid grain skirts with double beaded wellet and accent bands.

## 1966 SKYLARK & GRAN SPORT RALLYE SEAT

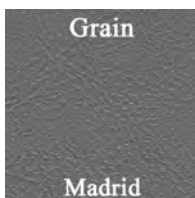

**(C) COLOR CODES:**

- (100G) Black
- (240G) Metallic Parchment
- (330G) Light Metallic Blue w/ Dark Metallic Blue Accent
- (518G) Metallic Red w/ Dark Metallic Red Accent

Front Buckets ..... **RS66GK00010(C)** <sup>OS2</sup>  
 100G, 330G, 518G..... \$1002/kit  
 240G..... \$1052/kit (L4)  
 ☞ Kit consists of: 1 pair Rallye Bucket Seat Covers, 1 set Rallye Seat Foam (4 pc.), 1 pair Stretch Panel Boards, 1 yd. Muslin, 30 ft. Listing Wire, 2 yd. Burlap, 9 ft. 2 inch Felt and 1 Dust Mask.

Headrest Covers..... **HC66GA00N14(C)**  
 100G, 330G, 518G ..... \$82/pr.  
 240G..... \$86/pr. (L4)  
 ☞ Non-original replacement covers for factory molded headrests.  
 ☞ Professional installation is highly recommended.

This Legendary product features as-original heat sealed Madrid grain inserts and Madrid grain skirts with double beaded wellet and accent bands.

## 1967 SKYLARK & GRAN SPORT "OEM STYLE"



**(C) COLOR CODES:**

- (100G) Black
  - (240G) Metallic Parchment (Requires Sample Approval)
  - (343G) Dark Metallic Blue
  - (448G) Dark Metallic Turquoise
  - (501G) Red
  - (640G) Pearl Yellow
- \*240G not available for convertible models

Front Buckets ..... **AA67GK00010(C)**  
 100G, 343G, 501G, 640G ..... \$574/pr.  
 240G, 448G ..... \$603/pr. (L4)  
 ☞ Molded foam is available for this model.  
 Please see the "GM Molded Foam" section in this catalog.

Rear Bench  
 Coupe & Sport Coupe ..... **AA67GK00048(C)**  
 Convertible ..... **AA67GK00056(C)**  
 100G, 343G, 501G, 640G ..... \$323/ea.  
 240G, 448G ..... \$339/ea. (L4)  
 ☞ 448G Dark Metallic Turquoise was not offered on a bucket seat interior trim style for a Convertible model in 1967.

Headrest Covers..... **HC66GA00N14(C)**  
 100G, 343G, 501G, 640G ..... \$82/pr.  
 240G, 448G ..... \$86/pr. (L4)  
 ☞ Non-original replacement covers for factory molded headrests.  
 ☞ Professional installation is highly recommended.

Convertible Rear Bench Back Panel  
 ..... **SK65GA00019(C)**  
 100G, 343G, 501G, 640G ..... \$79/ea.  
 240G, 448G ..... \$83/ea. (L4)

This Legendary product features as-original heat sealed Madrid grain inserts and Madrid grain skirts.

# 1967 SKYLARK & GRAN SPORT RALLYE SEAT

PHOTO N/A  
AT TIME OF  
PRINTING

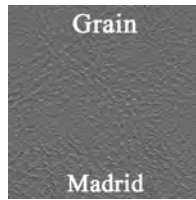

**(C) COLOR CODES:**

- (100G) Black
- (240G) Metallic Parchment (Requires Sample Approval)
- (343G) Dark Metallic Blue
- (448G) Dark Metallic Turquoise
- (501G) Red
- (640G) Pearl Yellow

Front Buckets ..... **RS67GK00010(C)** <sup>OS2</sup>  
 100G, 240G, 343G, 640G ..... \$1002/kit  
 240G, 448G ..... \$1052/kit (L4)  
 ☞ Kit consists of: 1 pair Rallye Bucket Seat Covers, 1 set Rallye Seat Foam (4 pc.), 1 pair Stretch Panel Boards, 1 yd. Muslin, 30 ft. Listing Wire, 2 yd. Burlap, 9 ft. 2 inch Felt and 1 Dust Mask.

Headrest Covers..... **HC66GA00N14(C)**  
 100G, 240G, 343G, 640G ..... \$82/pr.  
 240G, 448G ..... \$86/pr. (L4)  
 ☞ Non-original replacement covers for factory molded headrests.  
 ☞ Professional installation is highly recommended.

*This Legendary product features as-original heat sealed Madrid grain inserts and Madrid grain skirts.*

# 1968 SKYLARK CUSTOM, GRAN SPORT 350 & 400 "OEM STYLE"

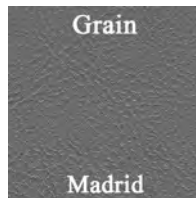

**(C) COLOR CODES:**

- (100G) Black
- (135G) NOS Platinum (Requires Sample Approval)
- (220G) Frost White
- (333G) Blue
- (709G) Buckskin

Front Buckets ..... **AA68GKD0010(C)**  
 100G, 220G ..... \$574/pr.  
 333G, 709G ..... \$603/pr. (L4)  
 135G ..... \$1191/pr. (L1)  
 ☞ Molded foam is available for this model.  
 Please see the "GM Molded Foam" section in this catalog.  
 ☞ Customer must reuse original metal buttons.

Rear Bench  
 Sport Coupe ..... **AA68GKD0048(C)**  
 Convertible ..... **AA68GKD0056(C)**  
 100G, 220G ..... \$357/ea.  
 333G, 709G ..... \$375/ea. (L4)  
 135G ..... \$933/ea. (L1)  
 ☞ 135G Platinum and 709G Buckskin were not offered on a bucket seat interior trim style for a Convertible model in 1968.  
 ☞ Customer must reuse original metal buttons.

*This Legendary product features as-original Heat Sealed Madrid grain inserts and Madrid grain skirts*

# 1968 SKYLARK CUSTOM, GRAN SPORT 350 & 400 RALLYE SEAT

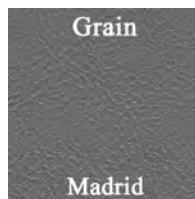

**(C) COLOR CODES:**

- (100G) Black
- (135G) NOS Platinum (Requires Sample Approval)
- (220G) Frost White
- (333G) Blue
- (709G) Buckskin

Front Buckets ..... **RS68GKD0010(C)** <sup>OS2</sup>  
 100G, 220G ..... \$1002/kit  
 333G, 709G ..... \$1052/kit (L4)  
 135G ..... \$1194/kit (L1)  
 ☞ Kit consists of: 1 pair Rallye Bucket Seat Covers, 1 set Rallye Seat Foam (4 pc.), 1 pair Stretch Panel Boards, 1 yd. Muslin, 30 ft. Listing Wire, 2 yd. Burlap, 9 ft. 2 inch Felt and 1 Dust Mask.

*This Legendary product features as-original Heat Sealed Madrid grain inserts and Madrid grain skirts*



**1969 SKYLARK CUSTOM, GRAN SPORT 350 & 400 "OEM STYLE"**

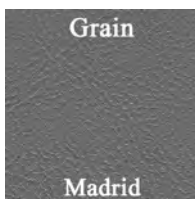

**(C) COLOR CODES:**  
 (100G) Black  
 (239G) Metallic Parchment  
 (325G) Metallic Blue  
 (503G) Red  
 (710G) Buckskin

*This Legendary product features as-original heat sealed Madrid grain inserts and Madrid grain skirts with heat sealed collars.*

Front Buckets .....**AA69GKD0010(C)**  
 100G, 239G, 325G .....\$574/pr.  
 503G, 710G .....\$603/pr. **(L4)**  
 ☞ Molded foam is available for this model.  
 Please see the "GM Molded Foam" section in this catalog.

Rear Bench  
 Sport Coupe .....**AA69GKD0048(C)**  
 Convertible .....**AA69GKD0056(C)**  
 100G, 239G, 325G .....\$323/ea.  
 503G, 710G .....\$339/ea. **(L4)**  
 ☞ 325G Metallic Blue and 710G Buckskin were not offered on a bucket seat interior trim style for a Convertible model in 1969.  
 ☞ 503G Red was not offered in a Coupe model in 1969.

Headrest Covers.....**HC69GA00014(C)**  
 100G, 239G, 325G .....\$82/pr.  
 503G, 710G .....\$86/pr. **(L4)**  
 ☞ Non-original replacement covers for factory molded headrests.  
 ☞ Professional installation is highly recommended.

**1969 SKYLARK CUSTOM, GRAN SPORT 350 & 400 RALLYE SEAT**



**(C) COLOR CODES:**  
 (100G) Black  
 (239G) Metallic Parchment  
 (325G) Metallic Blue  
 (503G) Red  
 (710G) Buckskin

*This Legendary product features as-original heat sealed Madrid grain inserts and Madrid grain skirts with heat sealed collars.*

Front Buckets .....**RS69GKD0010(C)**   
 100G, 239G, 325G .....\$1002/kit  
 503G, 710G .....\$1052/kit **(L4)**  
 ☞ Kit consists of: 1 pair Rallye Bucket Seat Covers, 1 set Rallye Seat Foam (4 pc.), 1 pair Stretch Panel Boards, 1 yd. Muslin, 30 ft. Listing Wire, 2 yd. Burlap, 9 ft. 2 inch Felt and 1 Dust Mask.

**1970 SKYLARK CUSTOM, GS & GS455 "OEM STYLE"**

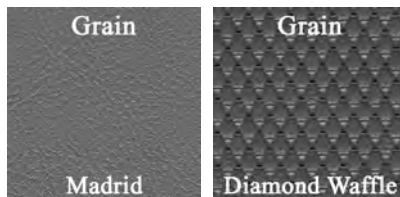

**(C) COLOR CODES:**  
 (100G) Black  
 (202G) Pearl White  
 (342G) Dark Metallic Blue  
 (658G) Burnished Saddle

*This Legendary product features as-original Diamond Waffle grain inserts and Madrid grain skirts.*

Front Buckets .....**AA70GK00010(C)**  
 (All Colors) ..... \$574/pr.  
 ☞ Molded foam is available for this model.  
 Please see the "GM Molded Foam" section in this catalog.

Rear Bench  
 Sport Coupe .....**AA70GKD0048(C)**  
 Convertible .....**AA70GKD0056(C)**  
 (All Colors).....\$323/ea.  
 ☞ 342G Dark Metallic Blue was not offered on a bucket seat interior trim style for a Convertible model in 1970. Convertible option originally offered on GS455 Models only.

Headrest Covers.....**HC69GA00014(C)**  
 (All Colors).....\$82/pr.  
 ☞ Non-original replacement covers for factory molded headrests.  
 ☞ Professional installation is highly recommended.

**1970 SKYLARK CUSTOM, GS & GS455 RALLYE SEAT**



Front Buckets ..... **RS70GK00010(C)** <sup>OS2</sup>  
 (All Colors) ..... \$1002/kit  
 Kit consists of: 1 pair Rallye Bucket Seat Covers,  
 1 set Rallye Seat Foam (4 pc.), 1 pair Stretch Panel  
 Boards, 1 yd. Muslin, 30 ft. Listing Wire, 2 yd. Burlap, 9  
 ft. 2 inch Felt and 1 Dust Mask.



**(C) COLOR CODES:**

- (100G) Black
- (202G) Pearl White
- (342G) Dark Metallic Blue
- (658G) Burnished Saddle

*This Legendary product features as-original Diamond Waffle grain inserts and Madrid grain skirts.*

**1971 SKYLARK, SKYLARK CUSTOM & GRAN SPORT "OEM STYLE"**

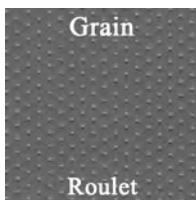
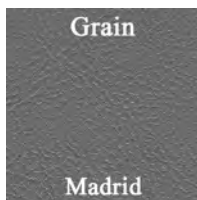

**(C) COLOR CODES:**

- (100G) Black
- (202G) Pearl White
- (690G) Saddle (1971)

Front Buckets ..... **AA71GK00010(C)**  
 (All Colors) ..... \$586/pr.  
 Molded foam is available for this model.  
 Please see the "GM Molded Foam" section in  
 this catalog.

Sport Coupe Rear ..... **AA71GK00048(C)**  
 ..... \$336/ea.

Headrest Covers..... **HC69GA00014(C)**  
 (All Colors)..... \$82/pr.

- Non-original replacement covers for factory molded headrests.
- Professional installation is highly recommended.

*This Legendary product features as-original Roulet grain inserts with accent belt and Madrid grain skirts*

**1971-72 SKYLARK, SKYLARK CUSTOM & GRAN SPORT RALLYE SEAT**



Front Buckets ..... **RS71GK00010(C)** <sup>OS2</sup>  
 100G, 202G, 230G, 690G..... \$1020/kit  
 670G..... \$1071/kit **(L4)**  
 Kit consists of: 1 pair Rallye Bucket Seat Covers, 1 set  
 Rallye Seat Foam (4 pc.), 1 pair Stretch Panel Boards, 1  
 yd. Muslin, 30 ft. Listing Wire, 2 yd. Burlap, 9 ft. 2 inch Felt  
 and 1 Dust Mask.

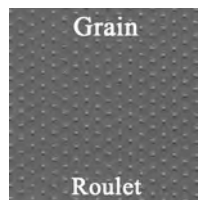
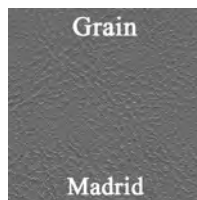

**(C) COLOR CODES:**

- (100G) Black
- (202G) Pearl White (1971)
- (230G) White (1972)
- (670G) Tan (1972)
- (690G) Saddle (1971)

*This Legendary product features as-original Roulet grain inserts with accent belt and Madrid grain skirts*



1972 SKYLARK, SKYLARK CUSTOM & GRAN SPORT "OEM STYLE"



**(C) COLOR CODES:**

- (100G) Black
- (230G) White
- (670G) Tan

Front Buckets .....**AA71GK00010(C)**  
 100G, 230G..... \$586/pr.  
 670G..... \$615/pr. **(L4)**  
 ☞ Molded foam is available for this model. Please see the "GM Molded Foam" section in this catalog.

Sport Coupe Rear .....**AA72GK00048(C)**  
 100G, 230G.....\$336/ea.  
 670G.....\$353/ea. **(L4)**

Headrest Covers.....**HC69GA00014(C)**  
 100G, 230G.....\$82/pr.  
 670G.....\$86/pr. **(L4)**  
 ☞ Non-original replacement covers for factory molded headrests.  
 ☞ Professional installation is highly recommended.

*This Legendary product features as-original Roulet grain inserts with accent belt and Madrid grain skirts*

1973-74 RIVIERA

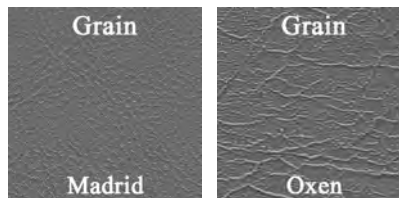

**1973 (C) COLOR CODES:**

- (100G) Black
- (230G) White
- (678G) Saddle

**1974 (C) COLOR CODES:**

- (230G) White
- (525G) Burgundy
- (672G) Saddle

1973 Front Buckets .....**AA73GR00010(C)**  
 (All Colors) ..... \$704/pr.  
 ☞ Please specify cut pile carpet color at time of order.

1973 Hardtop Coupe Rear .....**AA73GR00040(C)**  
 (All Colors).....\$461/ea.

1974 Front Buckets .....**AA73GR00010(C)**  
 (All Colors) ..... \$704/pr.  
 ☞ Please specify cut pile carpet color at time of order.

1974 Hardtop Coupe Rear .....**AA73GR00040(C)**  
 (All Colors).....\$461/ea.

*This Legendary product features as-original Oxen grain inserts and lower back panel with Madrid grain skirts and cut pile stretch panel*

1964 SKYLARK

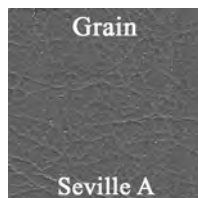

**(C) COLOR CODES:**

- (325G) Light Metallic Blue
- (508G) Red

Front Split Bench.....**AA64GK00026(C)**  
 (All Colors).....\$629/ea.

Convertible Rear .....**AA64GK00056(C)**  
 (All Colors).....\$376/ea.

Convertible Rear Bench Back Panel .....**SK64GA00019(C)**  
 (All Colors).....\$79/ea.

*This Legendary product features as-original heat sealed Seville grain inserts and Seville grain skirts with buttons.*

# 1965 SKYLARK

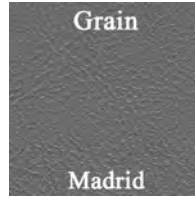
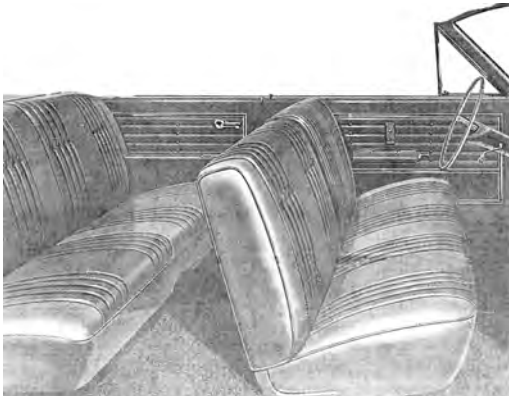

**(C) COLOR CODES:**  
 (100G) Black  
 (325G) Light Metallic Blue  
 (520G) Metallic Red

Front Split Bench ..... **AA65GK00026(C)**  
 (All Colors) ..... \$629/ea.

Convertible Rear  
 ..... **AA65GK00056(C)**  
 (All Colors) ..... \$376/ea.

Convertible Rear Bench Back Panel  
 ..... **SK65GA00019(C)**  
 (All Colors) ..... \$79/ea.

*This Legendary product features as-original Madrid grain inserts and Madrid grain skirts with buttons.*

# 1966 SPECIAL DELUXE, SKYLARK & GRAN SPORT

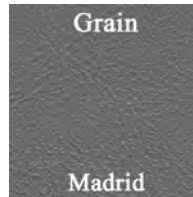

**(C) COLOR CODES:**  
 (100G) Black  
 (240G) Metallic Parchment  
 (330G) Light Metallic Blue w/  
 Dark Metallic Blue Accent  
 (485G) NOS Light Metallic Aqua w/  
 Dark Metallic Aqua Accent  
 (518G) Metallic Red w/  
 Dark Metallic Red Accent

**(C) HEADREST & REAR BACK  
 PANEL COLOR CODES:**  
 (100G) Black  
 (240G) Metallic Parchment  
 (325G) Light Metallic Blue  
 (420G) NOS Light Metallic Aqua  
 (520G) Metallic Red

*This Legendary product features as-original Madrid grain inserts and Madrid grain skirts with double beaded welt and accent bands.*

Front Split Bench with Center Armrest  
 ..... **AA66GK00030(C)**  
 100G, 330G, 518G ..... \$586/ea.  
 240G ..... \$615/ea. (L4)  
 485G ..... \$1181/ea. (L1)

Rear Bench  
 Coupe & Sport Coupe ..... **AA66GK00048(C)**  
 Convertible ..... **AA66GK00056(C)**  
 100G, 330G, 518G ..... \$323/ea.  
 240G ..... \$339/ea. (L4)  
 485G ..... \$868/ea. (L1)  
*240G Metallic Parchment and 485G Light Metallic Aqua w/ Dark Metallic Aqua accents were not offered on a split bench seat with center armrest interior trim style for Convertible models in 1966.*

Headrest Covers  
 ..... **HC66GA00014(C)**  
 100G, 330G, 518G ..... \$82/pr.  
 240G ..... \$86/pr. (L4)  
 420G ..... \$161/pr. (L1)  
 Headrest Covers (Zippered) **HC66GA000214(C)**  
 100G, 330G, 518G ..... \$102/pr.  
 240G ..... \$106/pr. (L4)  
 420G ..... \$184/pr. (L1)

Convertible Rear Bench Back Panel  
 ..... **SK65GA00019(C)**  
 100G, 325G, 520G ..... \$79/ea.  
 240G ..... \$83/ea. (L4)  
 420G ..... \$247/ea. (L1)



## 1966 SKYLARK



**(C) COLOR CODES:**  
 (100G) Black  
 (240G) Metallic Parchment

Front Split Bench ..... **AA66GK00020(C)**  
 100G..... \$586/ea.  
 240G..... \$615/ea. (L4)

Convertible Rear ..... **AA66GK00056(C)**  
 100G..... \$323/ea.  
 240G..... \$339/ea. (L4)

Headrest Covers..... **HC66GA00014(C)**  
 100G..... \$82/pr.  
 240G..... \$86/pr. (L4)  
 Headrest Covers (Zippered) ... **HC66GA00Z14(C)**  
 100G..... \$102/pr.  
 240G..... \$106/pr. (L4)

Convertible Rear Bench Back Panel ..... **SK65GA00019(C)**  
 100G..... \$79/ea.  
 240G..... \$83/ea. (L4)

This Legendary product features as-original Madrid grain inserts and Madrid grain skirts with double beaded welt and accent bands.

## 1967 SKYLARK & GRAN SPORT

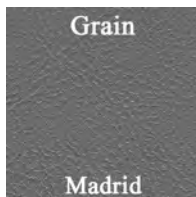

**(C) COLOR CODES:**  
 (100G) Black  
 (240G) Metallic Parchment  
 (Requires Sample Approval)  
 \*240G not available for convertible models

Front Split Bench ..... **AA67GK00020(C)**  
 100G..... \$574/ea.  
 240G..... \$603/ea. (L4)

Coupe & Sport Coupe Rear... ..... **AA67GK00048(C)**  
 100G..... \$323/ea.  
 240G..... \$339/ea. (L4)

Convertible Rear Bench ..... **AA67GK00056(C)**  
 (All Colors)..... \$323/ea.

Headrest Covers..... **HC66GA00014(C)**  
 100G..... \$82/pr.  
 240G..... \$86/pr. (L4)  
 Headrest Covers (Zippered) ... **HC66GA00Z14(C)**  
 100G..... \$102/pr.  
 240G..... \$106/pr. (L4)

Convertible Rear Bench Back Panel ..... **SK65GA00019(C)**  
 100G..... \$79/ea.  
 240G..... \$83/ea. (L4)

This Legendary product features as-original heat sealed Madrid grain inserts and Madrid grain skirts.

## 1967 SKYLARK CLOTH STYLE

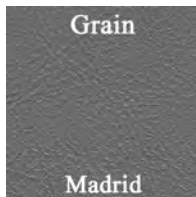
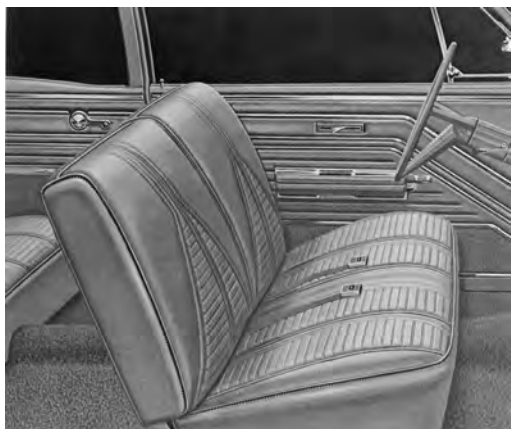

**(C) COLOR CODES:**  
 (812G) NOS Gold Cloth / Gold  
 (815G) NOS Blue Cloth / Lt Met Blue  
 (821G) NOS Black Cloth / Black

**(C) HEADREST COLOR CODES:**  
 (100G) Black  
 (310G) Light Metallic Blue  
 (650G) Gold

Front Split Bench ..... **AA67GKC0020(C)**  
 (All Colors)..... \$1022/ea. (L2)  
 ⚠812G, 815G & 821G use New Old Stock (NOS) cloth material.

Coupe & Sport Coupe Rear... ..... **AA67GKC0080(C)**  
 (All Colors)..... \$751/ea. (L2)  
 ⚠812G, 815G & 821G use New Old Stock (NOS) cloth material.

Headrest Covers..... **HC66GA00014(C)**  
 (All Colors)..... \$82/pr.  
 Headrest Covers (Zippered) ... **HC66GA00Z14(C)**  
 (All Colors)..... \$102/pr.

This Legendary product features NOS Cloth inserts and Madrid grain skirts

## 1967 SPECIAL DELUXE & SKYLARK



**(C) COLOR CODES:**

- (100G) Black
  - (240G) Metallic Parchment  
*(Requires Sample Approval)*
  - (343G) Dark Metallic Blue
  - (448G) Dark Met. Turquoise
  - (501G) Red
  - (680G) Saddle
- \*240G not available for convertible models*

*This Legendary product features as-original heat sealed Madrid grain inserts and Madrid grain skirts*

|   |                       |
|---|-----------------------|
| Front Split Bench with Center Armrest   | <b>AA67GK00030(C)</b> |
| 100G, 343G, 501G  | \$586/ea.             |
| 240G, 448G  | \$615/ea. (L4)        |
| 680G  | \$1181/ea. (L1)       |
| ☞ 680G Saddle uses special run material.  |                       |
| Rear Bench  |                       |
| Coupe /Sport Coupe  | <b>AA67GK00048(C)</b> |
| Convertible   | <b>AA67GK00056(C)</b> |
| 100G, 343G, 501G  | \$323/ea.             |
| 240G, 448G  | \$339/ea. (L4)        |
| 680G  | \$911/ea. (L1)        |
| ☞ 240G Metallic Parchment and 448G Dark Metallic Turquoise were not offered on a split bench seat with center armrest interior trim style for Convertible models in 1967. |                       |
| ☞ 680G Saddle uses special run material.  |                       |
| Headrest Covers   | <b>HC66GA00014(C)</b> |
| 100G, 343G, 501G  | \$82/pr.              |
| 240G, 448G  | \$86/pr. (L4)         |
| 680G  | \$161/pr. (L1)        |
| Headrest Covers (Zippered)  | <b>HC66GA00Z14(C)</b> |
| 100G, 343G, 501G  | \$102/pr.             |
| 240G, 448G  | \$106/pr. (L4)        |
| 680G  | \$184/pr. (L1)        |
| ☞ 680G Saddle uses special run material.  |                       |
| Convertible Rear Bench Back Panel   | <b>SK65GA00019(C)</b> |
| 100G, 343G, 501G  | \$ 79/ea.             |
| 680G  | \$247/ea. (L1)        |
| ☞ 680G Saddle uses special run material.  |                       |

## 1968 SKYLARK & SKYLARK CUSTOM

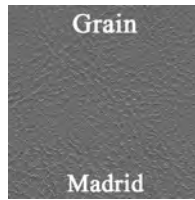

**(C) COLOR CODES:**

- (100G) Black
- (135G) NOS Platinum  
*(Requires Sample Approval)*
- (220G) Frost White
- (333G) Blue
- (502G) Red
- (709G) Buckskin

*This Legendary product features as-original Heat Sealed Madrid grain inserts and Madrid grain skirts*

|   |                       |
|---|-----------------------|
| Front Split Bench with Center Armrest   | <b>AA68GKD0030(C)</b> |
| 100G, 220G  | \$586/ea.             |
| 333G, 502G, 709G  | \$615/ea. (L4)        |
| 135G  | \$1204/ea. (L1)       |
| ☞ Customer must reuse original metal buttons.   |                       |
| Sport Coupe Rear  | <b>AA68GKD0048(C)</b> |
| 100G, 220G  | \$357/ea.             |
| 333G, 502G, 709G  | \$375/ea. (L4)        |
| 135G  | \$933/ea. (L1)        |
| ☞ 502G Red and 709G Buckskin were not offered on a split bench seat with center armrest for a Coupe model in 1968.                                |                       |
| ☞ Customer must reuse original metal buttons.   |                       |
| Convertible Rear  | <b>AA68GKD0056(C)</b> |
| 100G, 220G  | \$357/ea.             |
| 333G, 502G, 709G  | \$375/ea. (L4)        |
| 135G  | \$933/ea. (L1)        |
| ☞ 100G Black and 220G Frost White were not offered on a split bench seat with center armrest interior trim style for a Convertible model in 1968. |                       |
| ☞ Customer must reuse original metal buttons.   |                       |



## 1968 SKYLARK CUSTOM & GRAN SPORT 400



**(C) COLOR CODES:**  
 (100G) Black  
 (220G) Frost White

Front Split Bench.....**AA68GKD0020(C)**  
 (All Colors)..... \$586/ea.  
 ☞ Customer must reuse original metal buttons.

Sport Coupe Rear.....**AA68GKD0048(C)**  
 (All Colors).....\$357/ea.  
 ☞ Customer must reuse original metal buttons.

Convertible .....**AA68GKD0056(C)**  
 (All Colors).....\$357/ea.  
 ☞ Customer must reuse original metal buttons.

*This Legendary product features as-original Heat Sealed Madrid grain inserts and Madrid grain skirts*

## 1968 SKYLARK & GRAN SPORT 350

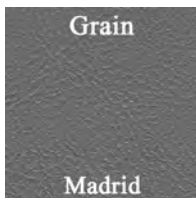

**(C) COLOR CODES:**  
 (100G) Black  
 (204G) Metallic Parchment  
 (333G) Blue

Front Split Bench.....**AA68GKS0020(C)**  
 100G, 204G..... \$586/ea.  
 333G..... \$615/ea. (L4)  
 ☞ Customer must reuse original metal buttons.

Sport Coupe Rear.....**AA68GKS0048(C)**  
 100G, 204G.....\$357/ea.  
 333G.....\$375/ea. (L4)  
 ☞ Customer must reuse original metal buttons.

*This Legendary product features as-original Madrid grain inserts and Madrid grain skirts.*

## 1969 SKYLARK & SKYLARK CUSTOM

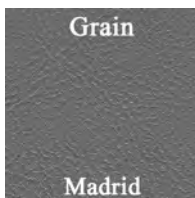
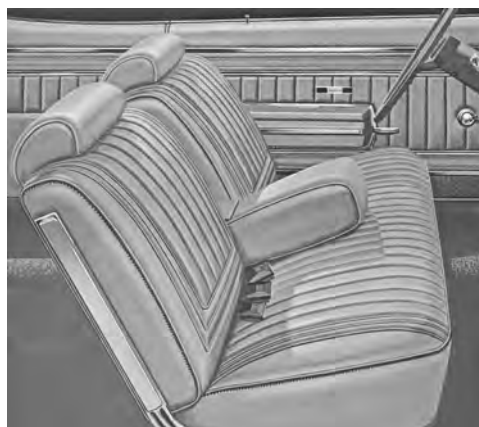

**(C) COLOR CODES:**  
 (100G) Black  
 (239G) Metallic Parchment  
 (325G) Metallic Blue  
 (450G) Metallic Green  
 (710G) Buckskin

Front Split Bench with Center Armrest  
 ..... **AA69GKD0030(C)**  
 100G, 239G, 325G.....\$586/ea.  
 710G.....\$615/ea. (L4)  
 450G.....\$1204/ea. (L1)  
 ☞ 450G Metallic Green uses special run material.

Sport Coupe Rear  
 ..... **AA69GKD0048(C)**  
 100G, 239G, 325G ..... \$323/ea.  
 710G ..... \$339/ea. (L4)  
 450G ..... \$933/ea. (L1)  
 ☞ 450G Metallic Green uses special run material.

Convertible Rear..... **AA69GKD0056(C)**  
 100G, 325G ..... \$323/ea.  
 710G ..... \$339/ea. (L4)  
 ☞ 239G Metallic Parchment and 450G Metallic Green were not offered on a split bench seat with center armrest interior trim style for a Convertible model in 1969.

Headrest Covers..... **HC69GA00N14(C)**  
 100G, 239G, 325G ..... \$82/pr.  
 710G ..... \$86/pr. (L4)  
 450G ..... \$161/pr. (L1)  
 ☞ 450G Metallic Green uses special run material.

*This Legendary product features as-original Madrid grain inserts and Madrid grain skirts with heat sealed center collar.*

## 1969 SKYLARK CUSTOM & GRAN SPORT 400

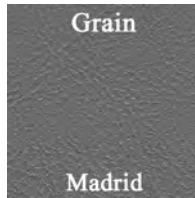

**(C) COLOR CODES:**  
 (100G) Black  
 (235G) Parchment

Front Split Bench ..... **AA69GKD0020(C)**  
 (All Colors) ..... \$586/ea.  
 Sport Coupe Rear..... **AA69GKD0048(C)**  
 (All Colors).....\$323/ea.  
 Convertible Rear..... **AA69GKD0056(C)**  
 (All Colors).....\$323/ea.  
 Headrest Covers  
 ..... **HC69GA00N14(C)**  
 (All Colors).....\$82/pr.

*This Legendary product features as-original Madrid grain inserts and Madrid grain skirts with heat sealed center collar.*

## 1969 SKYLARK & GRAN SPORT 350

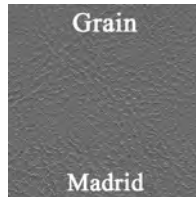

**(C) COLOR CODES:**  
 (100G) Black  
 (235G) Parchment  
 (325G) Metallic Blue

Front Split Bench ..... **AA69GKS0028(C)**  
 (All Colors) ..... \$586/ea.  
 ⚠️ Customer must reuse original metal buttons.  
 Sport Coupe Rear..... **AA69GKS0080(C)**  
 (All Colors).....\$323/ea.  
 ⚠️ Customer must reuse original metal buttons.  
 Headrest Covers  
 ..... **HC69GA00N14(C)**  
 (All Colors).....\$82/pr.

*This Legendary product features as-original heat sealed Madrid grain inserts and Madrid grain skirts.*

## 1970 SKYLARK SKYLARK CUSTOM, GS & GS 455

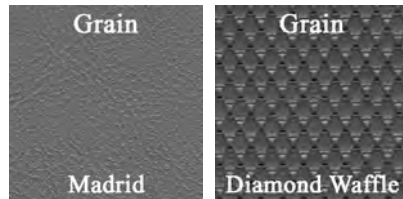

**(C) COLOR CODES:**  
 (100G) Black  
 (202G) Pearl White  
 (460G) Metallic Green  
 (658G) Burnished Saddle  
 (683G) Saddle

Front Split Bench with Center Armrest  
 ..... **AA70GKD0030(C)**  
 (All Colors) ..... \$586/ea.  
 Sport Coupe Rear  
 ..... **AA70GKD0048(C)**  
 (All Colors).....\$323/ea.  
 Convertible ..... **AA70GKD0056(C)**  
 (All Colors).....\$323/ea.  
 ⚠️ 100G Black, 460G Metallic Green and 683G Saddle were not offered on a split bench seat with center armrest interior trim style for a Convertible model in 1970.  
 Headrest Covers  
 ..... **HC70GA00014(C)**  
 (All Colors).....\$82/pr.

*This Legendary product features as-original Diamond Waffle grain inserts and Madrid grain skirts*



**1970 SKYLARK CUSTOM & GRAN SPORT 455**

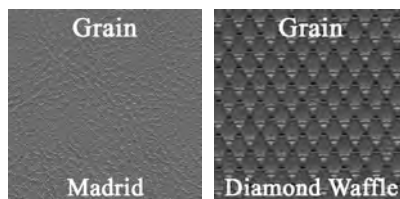

**(C) COLOR CODES:**

- (100G) Black
- (694G) Sandalwood

|                   |                |
|-------------------|----------------|
| Front Split Bench | AA70GKD0020(C) |
| (All Colors)      | \$586/ea.      |
| Convertible Rear  | AA70GKD0056(C) |
| (All Colors)      | \$323/ea.      |
| Headrest Covers   | HC70GA00014(C) |
| (All Colors)      | \$82/pr.       |

*This Legendary product features as-original Diamond Waffle grain inserts and Madrid grain skirts*

**1970 SKYLARK, GRAN SPORT & GRAN SPORT 455**

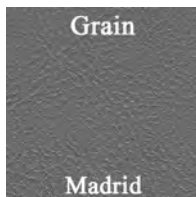

**(C) COLOR CODES:**

- (100G) Black
- (310G) Light Metallic Blue
- (694G) Sandalwood

|                   |  |
|-------------------|--|
| Front Split Bench | AA70GKS0020(C)                                       |
| (All Colors)      | \$586/ea.  |
|                   | <i>☞ Customer must reuse original metal buttons.</i> |
| Sport Coupe Rear  | AA70GKS0080(C)                                       |
| (All Colors)      | \$323/ea.  |
|                   | <i>☞ Customer must reuse original metal buttons.</i> |
| Headrest Covers   | HC70GA00014(C)                                       |
| (All Colors)      | \$82/pr.   |

*This Legendary product features as-original heat sealed Madrid grain inserts and Madrid grain skirts.*

**1971 SKYLARK, SKYLARK CUSTOM & GRAN SPORT**



**(C) COLOR CODES:**

- (100G) Black
- (202G) Pearl White
- (468G) Green
- (690G) Saddle
- (697G) Sandalwood

|                                       |   |
|---------------------------------------|---|
| Front Split Bench with Center Armrest | AA71GK00030(C)  |
| 100G, 202G, 690G                      | \$586/ea.   |
| 468G, 697G                            | \$615/ea. (L4)  |
| Sport Coupe Rear                      | AA71GK00048(C)  |
| 100G, 202G, 690G                      | \$336/ea.   |
| 468G, 697G                            | \$353/ea. (L4)  |
| Convertible Rear                      | AA71GK00056(C)  |
| 202G, 690G                            | \$336/ea.   |
| 468G                                  | \$353/ea. (L4)  |
|                                       | <i>☞ 100G Black and 697G Sandalwood were not offered on a split bench seat with center armrest interior trim style for a Convertible model in 1971.</i> |
| Headrest Covers                       | HC70GA00014(C)  |
| 100G, 202G, 690G                      | \$82/pr.  |
| 468G, 697G                            | \$86/pr. (L4)   |

*This Legendary product features as-original Roulet grain inserts and Madrid grain skirts and accent bands*

## 1971 SKYLARK & GRAN SPORT

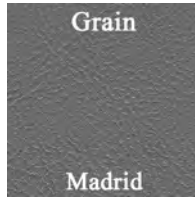

**(C) COLOR CODES:**  
 (100G) Black  
 (468G) Green  
 (697G) Sandalwood

|                         |                       |
|-------------------------|-----------------------|
| Front Split Bench ..... | <b>AA71GKM0020(C)</b> |
| 100G.....               | \$586/ea.             |
| 468G, 697G.....         | \$615/ea. (L4)        |
| Sport Coupe Rear .....  | <b>AA71GKM0080(C)</b> |
| 100G.....               | \$336/ea.             |
| 468G, 697G.....         | \$353/ea. (L4)        |
| Coupe Rear .....        | <b>AA71GKM0088(C)</b> |
| 100G.....               | \$336/ea.             |
| 468G, 697G.....         | \$353/ea. (L4)        |
| Headrest Covers .....   | <b>HC70GA00014(C)</b> |
| 100G.....               | \$82/pr.              |
| 468G, 697G.....         | \$86/pr. (L4)         |

*This Legendary product features as-original Heat Sealed Madrid grain inserts and Madrid grain skirts*

## 1971 SKYLARK CUSTOM & GRAN SPORT

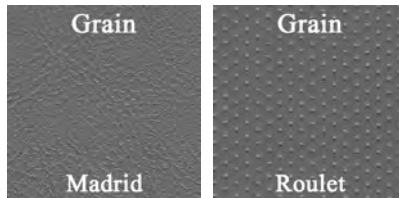

**(C) COLOR CODES:**  
 (100G) Black  
 (697G) Sandalwood

|                         |                       |
|-------------------------|-----------------------|
| Front Split Bench ..... | <b>AA71GK00020(C)</b> |
| 100G.....               | \$586/ea.             |
| 697G.....               | \$615/ea. (L4)        |
| Convertible Rear.....   | <b>AA71GK00056(C)</b> |
| 100G.....               | \$336/ea.             |
| 697G.....               | \$353/ea. (L4)        |
| Headrest Covers .....   | <b>HC70GA00014(C)</b> |
| 100G.....               | \$82/pr.              |
| 697G.....               | \$86/pr. (L4)         |

*This Legendary product features as-original Roulet grain inserts and Madrid grain skirts and accent bands.*

## 1972 SKYLARK, SKYLARK CUSTOM & GRAN SPORT

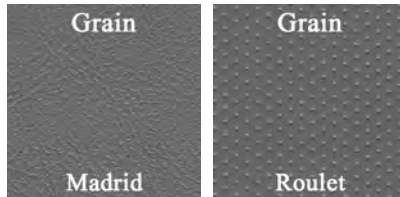

**(C) COLOR CODES:**  
 (100G) Black  
 (230G) White  
 (465G) Green  
 (690G) Saddle  
 (695G) NOS Sandalwood

|   |                       |
|---|-----------------------|
| Front Split Bench with Center Armrest .....   | <b>AA71GK00030(C)</b> |
| 100G, 230G, 690G.....   | \$586/ea.             |
| 465G.....   | \$615/ea. (L4)        |
| 695G.....   | \$1337/ea. (L1)       |
| Sport Coupe Rear .....  | <b>AA72GK00048(C)</b> |
| 100G, 230G, 690G.....   | \$336/ea.             |
| 465G.....   | \$353/ea. (L4)        |
| 695G.....   | \$1244/ea. (L1)       |
| Convertible Rear.....   | <b>AA72GK00056(C)</b> |
| 230G, 690G.....   | \$336/ea.             |
| 465G.....   | \$353/ea. (L4)        |
| <i>100G Black and 695G Sandalwood were not offered on a split bench seat with center armrest interior trim style for a Convertible model in 1972.</i> |                       |
| Headrest Covers .....   | <b>HC70GA00014(C)</b> |
| 100G, 230G, 690G.....   | \$82/pr.              |
| 465G.....   | \$86/pr. (L4)         |
| 695G.....   | \$161/pr. (L1)        |

*This Legendary product features as-original Roulet grain inserts and Madrid grain skirts and accent bands.*



## 1972 SKYLARK & GRAN SPORT



**(C) COLOR CODES:**

- (100G) Black
- (465G) Green
- (690G) Saddle

|                        |                       |
|------------------------|-----------------------|
| Front Split Bench..... | <b>AA71GKM0020(C)</b> |
| 100G, 690G.....        | \$586/ea.             |
| 465G.....              | \$615/ea. (L4)        |
| Sport Coupe Rear.....  | <b>AA72GKM0080(C)</b> |
| 100G, 690G.....        | \$336/ea.             |
| 465G.....              | \$353/ea. (L4)        |
| Coupe Rear.....        | <b>AA72GKM0088(C)</b> |
| 100G, 690G.....        | \$336/ea.             |
| 465G.....              | \$353/ea. (L4)        |
| Headrest Covers.....   | <b>HC70GA00014(C)</b> |
| 100G, 690G.....        | \$82/pr.              |
| 465G.....              | \$86/pr. (L4)         |

*This Legendary product features as-original Heat Sealed Madrid grain inserts and Madrid grain skirts.*

## 1972 SKYLARK CUSTOM & GRAN SPORT



**(C) COLOR CODES:**

- (100G) Black

|                        |                       |
|------------------------|-----------------------|
| Front Split Bench..... | <b>AA71GK00020(C)</b> |
| (All Colors).....      | \$586/ea.             |
| Convertible Rear.....  | <b>AA72GK00056(C)</b> |
| (All Colors).....      | \$336/ea.             |
| Headrest Covers        |                       |
| .....                  | <b>HC70GA00014(C)</b> |
| (All Colors).....      | \$82/pr.              |

*This Legendary product features as-original Roulet grain inserts and Madrid grain skirts and accent bands.*

### BUICK MODEL IDENTIFICATION

From 1964-1972 Buick offered the Skylark and Gran Sport in (3) different 2-door models: Coupe, Sport Coupe & Convertible. Shown is the basic identification for these models. Please note the difference between the Coupe (also known as a "pillared" coupe) and the Sport Coupe models.



GS Sport Coupe  
Skylark Sport Coupe  
Skylark Custom Sport Coupe  
\*NOTE: NO post between door glass and rear quarter glass



Skylark Custom Convertible  
GS Convertible



Skylark Coupe  
\*NOTE: Post between door glass and rear quarter glass

*\*1972 models shown in diagram*

## SEAT ADJUSTMENT KNOBS



TA64GA-KNOB TA67GA-KNOB TA71GA-KNOB

Reproduction seat knobs move the seat forward and back. These will work for both bucket and bench seats. For bucket seats use (2) knobs, for bench seats use (1) knob.

### 1964-65 Skylark & GS

**TA64GA-KNOB (Chrome)**.....\$29.00/ea.  
 ☞ Will work for 1966 models but fit is slightly different.

### 1967-70 Skylark & GS

**TA67GA-KNOB (Chrome)**.....\$10.00/ea.  
 ☞ Some 1970 models use black seat knobs.

### 1971-72 Skylark & GS

**TA71GA-KNOB (Black)**.....\$15.00/ea.

## BENCH SEATBACK RELEASE KNOB



This seat release knob allows the seatback to fold forward on bench seat models.

### 1967-72 Skylark & GS

**TA67GA-BNHKNOB (Chrome)**..... \$10.00/ea.

## BUCKET SEAT HEADRESTS

Reproduction bucket seat headrests made of molded urethane. Available in black only.



### 1966-67 Skylark & GS

**HR66GA01**.....\$285.00/pr.

### 1969 Skylark & GS

**HR69GA01**.....\$252.00/pr.

### 1970-72 Skylark & GS

**HR70GA01**.....\$252.00/pr.

## BUCKET SEAT SPRING ASSEMBLY

Reproduction seat assemblies for 1964-72 Skylark & GS replace fatigued or broken springs and restore the comfort and support of the originals. Avoid the mistake of restoring your bucket seats without new, properly tensioned seat springs.

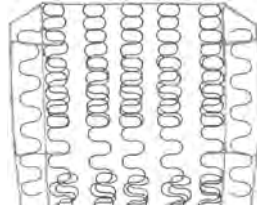

1964-65 Seatback (SA64GA-T)



1964-65 Seat bottom (SA64GA-B)

### 1964-65 Skylark & GS

**SA64GA-T (Seatback) (Shown)** ..... \$159.00/ea.  
**SA64GA-B (Seat bottom) (Shown)**...\$175.00/ea.

### 1966-67 Skylark & GS

**SA66GA-T (Seatback)** ..... \$175.00/ea.  
**SA66GA-B (Seat bottom)** .....\$175.00/ea.

### 1968-72 Skylark & GS

**SA68GA-T (1968 Seatback)** ..... \$175.00/ea.  
**SA69GA-T (1969-72 Seatback)** ..... \$159.00/ea.  
**SA68GA-B (Seat bottom)**..... \$159.00/ea.

## SEATBACK BUMPERS



BU64GA-BKKIT

BU66GA-BKKIT

Rubber bumpers for 1964-1972 bucket seat models. These bumpers keep the front seat tops in the correct upright position and mount on the backside of the front seat bottoms.

### 1964-65 Skylark & GS

**BU64GA-BKKIT (screws included)**.....\$11.00/pr.  
 ☞ These bumpers will also fit most 1964-72 Tempest, LeMans & GTO bench seats.

### 1966-72 Skylark & GS

**BU66GA-BKKIT (screws included)**.....\$10.00/pr.

## BUCKET SEAT MOUNT CONVERSION BRACKETS



Die-stamped steel brackets allow you to mount bucket seats in 1966-72 models originally equipped with a bench seat.

### TA66GA-BRACKET

☞ (1) set does (2) bucket seats. These brackets are to be welded near the transmission tunnel side so your inside bucket seat tracks can be mounted.

.....\$39.00/set

## 1966-67 BUCKET SEAT HEADREST MOUNTING KIT



### 1966-67 Skylark & GS

**HR66GA-BRACKET** ..... \$120.00/pr.

## BUCKET SEAT HEADRESTS BASE TRIM

Plastic base trim piece slides onto the headrest post and mounts to the underside of the headrest



HR68GA-BNH

### 1968-72 Skylark & GS

#### Bench Seat Style

**HR68GA-BNH01 (black)** .....\$26.00/pr.  
**HR68GA-BNH02 (white)** .....\$26.00/pr.

☞ Plastic fasteners NOT INCLUDED

☞ Available in black or white. For colors other than black or white, customer must paint to match their interior color.



HR68GA-BKT

### 1968-72 Skylark & GS

#### Bucket Seat Style

**HR68GA-BKT01 (black)**.....\$23.00/pr.  
**HR68GA-BKT02 (white)**.....\$23.00/pr.

☞ Plastic fasteners NOT INCLUDED

☞ Available in black or white. For colors other than black or white, customer must paint to match their interior color.



## 1964-65 BUCKET SEAT CHROME HINGE ROD END CAP



Chrome plated reproduction of the original end caps.

**SK64GA-CAP** .....\$5.00/ea.

## 1969-72 BUCKET HEADREST LOCK ASSEMBLY

Authentic reproduction chrome plated bucket seat headrest locks include the escutcheon and lock as part of the lock assembly. These mount to the bucket front seat tops where the headrest posts slide into the seat.



**1969 Skylark & GS**  
**HR69GA-COVER** .....\$65.00/pr.

**1970-72 Skylark & GS**  
**HR70GA-COVER (shown)** .....\$54.00/pr.

## BUCKET SEATBACK RELEASE BUTTONS

These seat release buttons allow the seatback to fold forward on bucket seat models.



**1967-68 Skylark & GS**  
**SK67GA-BUTTON** .....\$54.00/ea.

**1969-72 Skylark & GS**  
**SK69GA-BUTTON** .....\$43.00/ea.

## SEAT BOTTOM STRETCH PANEL BOARDS

Die-cut seat bottom stretch panel boards for 1965-72 bucket seats. These panel boards attach to the backside of the bottom seat frame under the upholstery.



**1965 Skylark & GS**  
**SK65GA-PANEL (Bucket seats only)** ...\$27.00/pr.

**1966-67 Skylark & GS**  
**SK66GA-BNHPANEL (Bench seats only)**..\$37.00/ea.



**1966-72 Skylark & GS**  
**SK66GA-PANEL (Bucket seats only)** .....\$6.00/pr.

## FOAM & COTTON ACCESSORIES

- Cotton Batting (1 Roll)
- TACOTTONROLL** <sup>OS2</sup> .....\$48.00/ea.
- ☞ 1 Roll consists of 10 lbs.
- ☞ Must be used in conjunction with Legendary muslin.
- Muslin (1 yard)
- TAYDMUSLIN**.....\$ 3.00/yd.
- ☞ Must be used in conjunction with Legendary cotton batting.
- High Density Foam
- TAFOAM1 (1.5" thick x12" x12")** .....\$20.00/ea.
- TAFOAM2 (1.5" thick x 24" x 24")** .....\$38.00/ea.
- TAFOAM3 (1.5" thick x 30" x 70")** <sup>OS1</sup>.....\$82.00/ea.
- Burlap (36" wide)
- TABURLAP** .....\$ 3.00/yd.
- Paper Coated Wire
- TAPAPERWIRE**.....\$ 2.50/ft.

## HOG RING PLIER KITS



- Standard Hog Ring Plier Kit
- TAHOG** .....\$ 8.00/ea.
- ☞ Kit contains pliers and enough hog rings for a front or rear installation only.
- Deluxe Hog Ring Plier Kit
- TAHOHVY (shown)**.....\$39.00/ea.
- ☞ Kit contains heavy duty pliers and enough hog rings for a complete front and rear installation.
- Hog Rings (Pkg/200)
- TAHOGRING200**.....\$ 5.00/pk.

1966-72 BUCKET SEATBACKS



Reproduction seatbacks are made of original-style heat-stamped plastic and feature the correct Madrid grain look. Each seatback has been manufactured to original specifications. Chrome beading included.

**1966 Skylark & GS**  
**SK66GA01T (Black)**..... discontinued  
**SK66GA(C)T (Colors)**..... discontinued  
 ☞ 1966 seatbacks were originally metal.

**1968 Skylark & GS**  
**SK68GA01T (Black)**..... \$131.00/pr.  
**SK68GA(C)T (Colors)**..... \$131.00/pr.  
 ☞ Please specify color at time of order.

**1969-72 Skylark & GS**  
**SK69GA01T (Black)**..... \$131.00/pr.  
**SK69GA(C)T (Colors)**..... \$131.00/pr.  
 ☞ Please specify color at time of order.

1966-72 BUCKET SEAT BASES



Reproduction lower seat bases are made of original-style heat-stamped plastic and feature the correct Madrid grain look. Chrome beading included. Please specify color at time of order.

☞ (1) pair = (1) seat, (2) pairs required for (2) seats.  
 ☞ Please specify color at time of order.  
 ☞ 1966-67 seat bases were originally metal.

**1966-67 Skylark & GS**  
**SK66GA01B (Black)**.....\$109.00/pr.  
**SK66GA(C)B (Colors)**.....\$109.00/pr.

**1968 Skylark & GS**  
**SK68GA01B (Black)**.....\$109.00/pr.  
**SK68GA(C)B (Colors)**.....\$109.00/pr.

**1969-72 Skylark & GS**  
**SK69GA01B (Black)**.....\$109.00/pr.  
**SK69GA(C)B (Colors)**.....\$109.00/pr.

| 1966 COLOR CODES (C) |                  |
|----------------------|------------------|
| (01) Black           | (04) Turquoise   |
| (02) White           | (10) Bright Blue |
| (03) Red             | (18) Light Blue  |

| 1967 COLOR CODES (C) |                  |
|----------------------|------------------|
| (01) Black           | (04) Turquoise   |
| (02) White           | (10) Bright Blue |
| (03) Red             | (18) Light Blue  |

| 1968 COLOR CODES (C) |                          |
|----------------------|--------------------------|
| (01) Black           | (18) Light Blue          |
| (03) Red             | (204) Metallic Parchment |
| (11) Medium Blue     |                          |

| 1969-72 COLOR CODES (C) |                          |
|-------------------------|--------------------------|
| (01) Black              | (27) Light Saddle        |
| (02) White              | (29) Dark Saddle         |
| (03) Red                | (38) Sandalwood          |
| (07) Dark Blue          | (235) Parchment          |
| (10) Bright Blue        | (239) Metallic Parchment |
| (13) Dark Green         |                          |

1966-72 BUCKET SEAT CHROME TRIM & "BULLET" END CAPS



**Chrome Trim**  
**SK66GA-CHR**.....\$32.00/set



**"Bullet" End Caps**  
**SK66GA-CAP (Set/12)**.....\$32.00/set



Check out our Official **FAST FACTS!!** **LEGENDARY Tech Topics** with C.O.O. and Technical Muscle Car Guru Brian Ridley at [blog.legendariautointeriors.com](http://blog.legendariautointeriors.com)





# MOLDED FOAM AND FOAM ACCESORIES

 [facebook.com/legendaryautointeriors](https://facebook.com/legendaryautointeriors)  
 [twitter.com/legendaryautoin](https://twitter.com/legendaryautoin)

 [www.legendaryautointeriors.com](https://www.legendaryautointeriors.com)  
 [instagram.com/legendaryautointeriorsltd](https://instagram.com/legendaryautointeriorsltd)  
 [youtube.com/user/legendaryauto](https://youtube.com/user/legendaryauto)

## ORIGINAL REPRODUCTION SEAT FOAM

Don't put new seat covers over old deteriorated foam cushions! With these foam kits you will enjoy the appearance and comfort of factory new again in your Skylark and Gran Sport. These foam kits feature an exclusive cold cure molding process and a limited lifetime guarantee.



### 1964-65 BUCKET SEAT FOAM

Molded foam for 1964-65 Skylark and Gran Sport models with bucket seats. Sets consist of a pair of (2) front seat tops and (2) front seat bottoms.



**MF62GA** ..... \$369.00/set  
 ☞ Professional installation is highly recommended. Please see our installation services at the back of the catalog.

### 1966 BUCKET SEAT FOAM

Molded foam for 1966 Skylark and Gran Sport models with bucket seats. Sets consist of a pair of (2) front seat tops and (2) front seat bottoms.



**MF66GA** ..... \$369.00/set  
 ☞ Professional installation is highly recommended. Please see our installation services at the back of the catalog.

### 1967 & 1969-70 SKYLARK/GS BUCKET SEAT FOAM

Molded foam for 1967 Skylark/Gran Sport and 1969-70 Skylark/Gran Sport models with bucket seats. Sets consist of a pair of (2) front seat tops and (2) front seat bottoms.



**MF67GA** ..... \$369.00/set  
 ☞ Professional installation is highly recommended. Please see our installation services at the back of the catalog.

### 1968 & 1971-72 SKYLARK/GS BUCKET SEAT FOAM

Molded foam for 1968 Skylark/Gran Sport and 1971-72 Skylark/Gran Sport models with bucket seats. Sets consist of a pair of (2) front seat tops and (2) front seat bottoms.



**MF71GA** ..... \$369.00/set  
 ☞ Professional installation is highly recommended. Please see our installation services at the back of the catalog.



1966-70 BENCH SEAT FOAM

Molded foam for 1966-70 Skylark and Gran Sport models with bench seats. Sets consist of (1) front seat top and (1) front seat bottom.



MF66GA-BENCH

\$399.00/set

Professional installation is highly recommended. Please see our installation services at the back of the catalog.

1971-72 BENCH SEAT FOAM

Molded foam for 1971-72 Skylark and Gran Sport models with bench seats. Sets consist of (1) front seat top and (1) front seat bottom.



MF71GA-BENCH

\$509.00/set

Professional installation is highly recommended. Please see our installation services at the back of the catalog.

SEAT INSTALLATION KITS

HARDTOP AND CONVERTIBLE REAR SEATS

All 1964-72 General Motors A-Body



INSTALLATION-KIT2.....\$279.00/ea.

Kit includes: (1) 30"x70" 1 1/2" thick foam, (1) 10lb. roll of cotton, 4 yards of burlap, 4 yards of paper coated listing wire, 2 yards of muslin, (1) 3 1/2" x 64" Wire Edge Reinforced Burlap Cotton Support Band & a dust mask.

SPLIT BENCH & FULL BENCH FRONT SEATS

All 1964-72 General Motors A-Body  
\*With & Without Center Armrest



INSTALLATION-KIT4.....\$279.00/ea.

Kit includes: (1) 30"x70" 1 1/2" thick foam, (1) 10lb. roll of cotton, 4 yards of burlap, 4 yards of paper coated listing wire, 2 yards of muslin, 3 yards of 2 inch wide felt, (1) 3 1/2" x 64" Wire Edge Reinforced Burlap Cotton Support Band & a dust mask.

BUCKET FRONT SEATS



Kit 10 - 1964-65

INSTALLATION-KIT10.....\$89.00/ea.

Kit includes: (1) 5lb. roll of cotton, 2 yards of burlap, 45 feet of paper coated listing wire, 3 yards of 2 inch wide felt, (1) 3 1/2" x 64" Wire Edge Reinforced Burlap Cotton Support Band a dust mask & Side Hinge Felt.

BUCKET FRONT SEATS

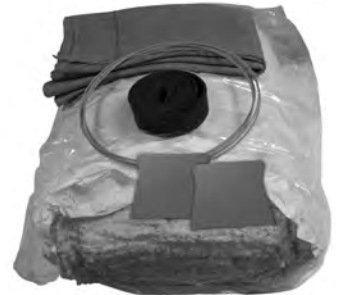

Kit 3 - 1966-72

INSTALLATION-KIT3.....\$69.00/ea.

Kit includes: (1) 5lb. roll of cotton, 3 yards of burlap, 45 feet of paper coated listing wire, 3 yards of 2 inch wide felt, (2) stretch panel boards & a dust mask.

# INSTALLATION SERVICES

## GM, CHRYSLER & AMC SEAT UPHOLSTERY

(Includes tear down of original upholstery and installation of new upholstery)



Front Buckets Install - \$500.00/pr.  
(No Headrest Covers)



Front Buckets w/ Headrest Covers Install - \$600.00/pr.



Front Split Bench Install - \$575.00/ea.



Front Split Bench w/ Headrest Covers Install - \$675.00/ea.



Rear Bench Seat Install - \$400.00/ea.



Headrest Covers Install - \$150.00/pr.

Center Armrest Install - \$150.00/ea.  
(for models w/ buckets and no console)



## SAVE ON COMPLETE FRONT & REAR INSTALLS!!

Front Buckets & Rear Bench Seat Install - \$750.00/set

Front Buckets w/ Headrest Covers & Rear Bench Seat Install - \$850.00/set

Front Split Bench & Rear Bench Seat Install - \$825.00/set



Front Split Bench w/ Headrest Covers & Rear Bench Seat Install - \$925.00/set



*\*NOTE\* Basic installations DO NOT include new foam and cotton replacement or reconstruction, media blasting, painting, welding, frame straightening, polishing or trim detailing. These services are additional and available at an hourly rate. Please call for more details. 1-800-363-8804*





# DOOR PANEL AND TRIM ACCESORIES

 [facebook.com/legendaryautointeriors](https://facebook.com/legendaryautointeriors)  
 [twitter.com/legendaryautoin](https://twitter.com/legendaryautoin)

 [www.legendaryautointeriors.com](http://www.legendaryautointeriors.com)  
 [instagram.com/legendaryautointeriorsltd](https://instagram.com/legendaryautointeriorsltd)  
 [youtube.com/user/legendaryauto](https://youtube.com/user/legendaryauto)

# 1964 SKYLARK



**Padded Multi-Level Construction 3D Panel**

**(C) COLOR CODES:**

- (111G) Black with Silver Accent Band
- (221G) Frost White with Black Accent Band
- (311G) Light Blue with Powder Blue Accent Band
- (370G) Dark Blue with Powder Blue Accent Band
- (426G) Green with Frost White Accent Band
- (509G) Red with Frost White Accent Band
- (675G) Brown with Frost White Accent Band

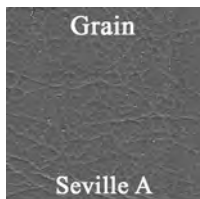

Grain

Seville A

**(C) ARMREST/WELL COVER COLOR CODES:**

- (100G) Black
- (220G) Frost White
- (325G) Light Blue
- (334G) Dark Blue
- (405G) Green
- (508G) Red
- (656G) Brown

This Legendary product features as-original Die-electrically heat sealed Seville A grain vinyl Seville grain accent band, buttons and carpeted lower section. Special cutout area in filler board to accommodate armrest base. Padded Multi-Level Construction 3-Dimensional Panel.

NOTE: Customer must reuse original decorative trim and medallions. Medallions are available. See following section of catalog.

|   |                       |
|---|-----------------------|
| Front Panels .....  | <b>DO64GK00012(C)</b> |
| 111G, 221G, 509G, 675G.....   | \$505/pr.             |
| 311G, 370G .....  | \$630/pr. (L1)        |
| 426G.....   | \$905/pr. (L1)        |
| ☞ Please specify carpet color and accent band color at time of order. |                       |
| ☞ Customer must reuse original metal trim.                            |                       |
| ☞ 311G, 370G & 426G Green uses special run material.                  |                       |

|  |                       |
|--|-----------------------|
| Sport Coupe Rear Panels.....                         | <b>DO64GK00048(C)</b> |
| 111G, 221G, 509G, 675G.....                          | \$291/pr.             |
| 370G.....  | \$406/pr. (L1)        |
| 426G.....  | \$446/pr. (L1)        |
| ☞ Please specify accent band color at time of order. |                       |
| ☞ Customer must reuse original metal trim.           |                       |
| ☞ 370G & 426G Green uses special run material.       |                       |

|   |                       |
|---|-----------------------|
| Sport Coupe Armrest/Well Covers...      | <b>AW64GA00048(C)</b> |
| 100G, 220G, 508G .....                  | \$82/pr.              |
| 334G, 656G .....                        | \$86/pr. (L4)         |
| 405G.....                               | \$183/pr. (L1)        |
| ☞ 405G Green uses special run material. |                       |

|  |                       |
|--|-----------------------|
| Convertible Rear Panels .....                        | <b>DO64GK00056(C)</b> |
| 111G, 221G, 509G, 675G.....                          | \$291/pr.             |
| 311G .....   | \$406/pr. (L1)        |
| 426G.....  | \$423/pr. (L1)        |
| ☞ Please specify accent band color at time of order. |                       |
| ☞ Customer must reuse original metal trim.           |                       |
| ☞ 311G & 426G Green uses special run material.       |                       |

|   |                       |
|---|-----------------------|
| Convertible Armrest/Well Covers...      | <b>AW64GA00056(C)</b> |
| 100G, 220G, 325G, 508G .....            | \$101/pr.             |
| 656G.....                               | \$106/pr. (L4)        |
| 405G.....                               | \$225/pr. (L1)        |
| ☞ 405G Green uses special run material. |                       |

# 1965 SKYLARK & GRAN SPORT



**Padded Multi-Level Construction 3D Panel**

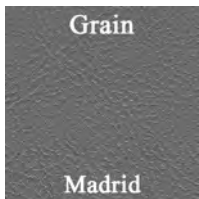

Grain

Madrid

**(C) COLOR CODES:**

- (100G) Black
- (220G) Frost White
- (325G) Light Metallic Blue
- (343G) Dark Metallic Blue
- (520G) Metallic Red
- (679G) Saddle

This Legendary product features as-original Die-electrically heat sealed Seville A grain vinyl Seville grain accent band, buttons and carpeted lower section. Special cutout area in filler board to accommodate armrest base. Padded Multi-Level Construction 3-Dimensional Panel.

NOTE: Customer must reuse original decorative trim and medallions. Medallions are available. See following section of catalog.

|   |                       |
|---|-----------------------|
| Front Panels .....                              | <b>DO65GK00012(C)</b> |
| 100G, 220G, 325G, 343G, 520G.....               | \$436/pr.             |
| 679G.....                                       | \$905/pr. (L1)        |
| ☞ Please specify carpet color at time of order. |                       |
| ☞ Customer must reuse original metal trim.      |                       |

|  |                       |
|--|-----------------------|
| Sport Coupe Rear Panels....  | <b>DO65GK00048(C)</b> |
| 100G, 220G, 325G, 343G, 520G .....   | \$222/pr.             |
| 679G.....  | \$446/pr. (L1)        |
| ☞ Customer must reuse original metal trim.   |                       |
| ☞ 100G Black was not offered on a bucket seat interior trim style for a Sport Coupe model in 1965. |                       |

|   |                       |
|---|-----------------------|
| Convertible Rear Panels.....  | <b>DO65GK00056(C)</b> |
| 100G, 220G, 325G, 343G, 520G.....   | \$222/pr.             |
| 679G.....   | \$423/pr. (L1)        |
| ☞ Customer must reuse original metal trim.  |                       |
| ☞ 343G Dark Metallic Blue was not offered on a bucket seat interior trim style for a Convertible model in 1965. |                       |

|                                       |                       |
|---------------------------------------|-----------------------|
| Sport Coupe Armrest/Well Covers ..... | <b>AW65GA00048(C)</b> |
| 100G, 220G, 325G, 343G, 520G.....     | \$82/pr.              |
| 679G.....                             | \$183/pr. (L1)        |

|                                       |                       |
|---------------------------------------|-----------------------|
| Convertible Armrest/Well Covers ..... | <b>AW65GA00056(C)</b> |
| 100G, 220G, 325G, 343G, 520G.....     | \$101/pr.             |
| 679G.....                             | \$225/pr. (L1)        |



**1966 SPECIAL DELUXE, SKYLARK & GRAN SPORT**

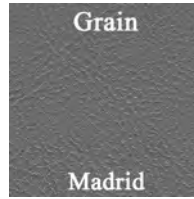

**(C) COLOR CODES:**

- (100G) Black
- (240G) Metallic Parchment
- (325G) Light Metallic Blue
- (420G) NOS Light Metallic Aqua
- (520G) Metallic Red

This Legendary product features as-original Die-electrically heat sealed Madrid grain vinyl with chrome accent strips and carpeted lower section. Special cutout area in filler board to accommodate armrest base. Padded Multi-Level Construction 3-Dimensional Panel.

NOTE: Customer must reuse original decorative trim and medallions. Medallions are available. See following section of catalog.

|   |                       |
|---|-----------------------|
| Front Panels .....                              | <b>DO66GKD0012(C)</b> |
| 100G, 325G, 520G.....                           | \$421/pr.             |
| 240G.....                                       | \$442/pr. (L4)        |
| 420G.....                                       | \$803/pr. (L1)        |
| ☞ Please specify carpet color at time of order. |                       |
| ☞ Customer must reuse original metal trim.      |                       |

|  |                       |
|--|-----------------------|
| Coupe & Sport Coupe Rear Panels .....      | <b>DO66GKD0048(C)</b> |
| 100G, 325G, 520G .....                     | \$222/pr.             |
| 240G.....                                  | \$233/pr. (L4)        |
| 420G.....                                  | \$349/pr. (L1)        |
| ☞ Customer must reuse original metal trim. |                       |

|   |                       |
|---|-----------------------|
| Conv Rear Panels .....  | <b>DO66GKD0056(C)</b> |
| 100G, 325G, 520G .....  | \$222/pr.             |
| 240G.....   | \$233/pr. (L4)        |
| ☞ Customer must reuse original metal trim.                                  |                       |
| ☞ 420G Light Metallic Aqua was not offered for a Convertible model in 1966. |                       |

|   |                       |
|---|-----------------------|
| Coupe & Sport Coupe Armrest/Well Covers ..... | <b>AW65GA00048(C)</b> |
| 100G, 325G, 520G .....                        | \$82/pr.              |
| 240G.....                                     | \$86/pr. (L4)         |
| 420G.....                                     | \$183/pr. (L1)        |

|                                       |                       |
|---------------------------------------|-----------------------|
| Convertible Armrest/Well Covers ..... | <b>AW66GA00056(C)</b> |
| 100G, 325G, 420G, 520G .....          | \$101/pr.             |
| 240G.....                             | \$106/pr (L4)         |

**1967 SPECIAL DELUXE, SKYLARK & GRAN SPORT**

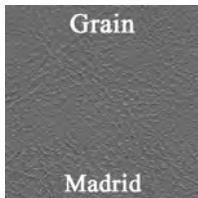

**(C) COLOR CODES:**

- (100G) Black
- (240G) Metallic Parchment (Requires Sample Approval)
- (310G) Light Metallic Blue
- (343G) Dark Metallic Blue
- (448G) Dark Metallic Turquoise
- (501G) Red
- (640G) Pearl Yellow
- (650G) Gold
- (680G) Saddle

\*240G not available for convertible models

This Legendary product features as-original Die-electrically heat sealed Madrid grain vinyl with chrome accent strips and carpeted lower section. Special cutout area in filler board to accommodate armrest base. Padded Multi-Level Construction 3-Dimensional Panel. NOTE: Customer must reuse original decorative trim and medallions. Medallions are available. See following section of catalog.

|                        |                       |
|------------------------|-----------------------|
| Front Panels .....     | <b>DO67GKD0012(C)</b> |
| 100G, 310G, 343G, 501G |                       |
| 640G, 650G .....       | \$421/pr.             |
| 240G, 448G .....       | \$442/pr. (L4)        |
| 680G.....              | \$803/pr. (L1)        |

- ☞ Please specify carpet color at time of order.
- ☞ Customer must reuse original metal trim.
- ☞ 680G Saddle uses special run material.
- ☞ 310G Light Metallic Blue and 650G Gold were available with a Cloth Bench interior trim style only.

|                              |                       |
|------------------------------|-----------------------|
| Sport Coupe Rear Panels..... | <b>DO67GKD0048(C)</b> |
| 100G, 310G, 343G, 501G       |                       |
| 640G, 650G .....             | \$222/pr.             |
| 240G, 448G .....             | \$233/pr. (L4)        |
| 680G.....                    | \$349/pr. (L1)        |

- ☞ 680G Saddle uses special run material.
- ☞ 310G Light Metallic Blue and 650G Gold were available with a Cloth Bench interior trim style only.

|  |                       |
|--|-----------------------|
| Sport Coupe Armrest/Well Covers...       | <b>AW65GA00048(C)</b> |
| 100G, 310G, 343G, 501G, 640G, 650G...    | \$82/pr.              |
| 204G, 448G .....                         | \$82/pr. (L4)         |
| 680G.....                                | \$183/pr. (L1)        |
| ☞ 680G Saddle uses special run material. |                       |

|                              |                       |
|------------------------------|-----------------------|
| Convertible Rear Panels..... | <b>DO67GKD0056(C)</b> |
| 100G, 343G, 501G, 640G ..... | \$222/pr.             |
| 240G.....                    | \$233/pr. (L4)        |
| 680G.....                    | \$349/pr. (L1)        |

- ☞ 680G Saddle uses special run material.
- ☞ 310G Light Metallic Blue, 448G Dark Metallic Aqua and 650G Gold were not offered for a Convertible model in 1967.

|  |                       |
|--|-----------------------|
| Convertible Armrest/Well Covers.....     | <b>AW66GA00056(C)</b> |
| 100G, 220G, 343G, 501G, 640G.....        | \$101/pr.             |
| 240G.....                                | \$106/pr. (L4)        |
| 680G.....                                | \$225/pr. (L1)        |
| ☞ 680G Saddle uses special run material. |                       |

## 1968 SKYLARK & GRAN SPORT 350

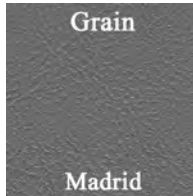

**(C) COLOR CODES:**

- (100G) Black
- (201G) Metallic Parchment / Black
- (333G) Blue

|  |                          |
|--|--------------------------|
| <b>Front Panels</b>                        |                          |
| (Unassembled) .....                        | <b>DO68GKS0012(C)</b>    |
| 100G, 201G .....                           | \$482/pr.                |
| 333G .....                                 | \$506/pr. (L4)           |
| (Pre-assembled) <sup>OS1</sup> .....       | <b>DO68GKS0012(C)-PA</b> |
| 100G, 201G .....                           | \$635/pr.                |
| 333G .....                                 | \$667/pr. (L4)           |
| ☞ Customer must provide upper rails.       |                          |
| ☞ Customer must reuse original metal trim. |                          |
| <b>Sport Coupe Rear Panels</b>             |                          |
| (Unassembled) .....                        | <b>DO68GKS0048(C)</b>    |
| 100G, 201G .....                           | \$333/pr.                |
| 333G .....                                 | \$350/pr. (L4)           |
| (Pre-assembled) <sup>OS1</sup> .....       | <b>DO68GKS0048(C)-PA</b> |
| 100G, 201G .....                           | \$507/pr.                |
| 333G .....                                 | \$532/pr. (L4)           |
| ☞ Customer must provide upper rails.       |                          |
| ☞ Customer must reuse original metal trim. |                          |

This Legendary product features as-original Die-electrically heat sealed Madrid grain vinyl with chrome accent belt. Special cutout area in filler board to accommodate armrest base. Padded Multi-Level Construction 3-Dimensional Panel.  
 NOTE: Customer must reuse original decorative trim and medallions. Medallions are available. See following section of catalog.

## 1968 SKYLARK, SKYLARK CUSTOM, GS 350 & 400

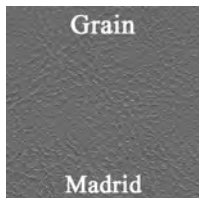

**(C) COLOR CODES:**

- (100G) Black
- (135G) NOS Platinum  
(Requires Sample Approval)
- (220G) Frost White
- (333G) Blue
- (502G) Red
- (709G) Buckskin

This Legendary product features as-original Die-electrically heat sealed Madrid grain vinyl with chrome accent strips and carpeted lower section. Special cutout area in filler board to accommodate armrest base. Padded Multi-Level Construction 3-Dimensional Panel.

NOTE: Customer must reuse original decorative trim and medallions. Medallions are available. See following section of catalog.

|   |                          |
|---|--------------------------|
| <b>Front Panels</b>                                       |                          |
| (Unassembled) .....                                       | <b>DO68GKD0012(C)</b>    |
| 100G, 220G .....  | \$482/pr.                |
| 333G, 502G, 709G .....                                    | \$506/pr. (L4)           |
| 135G .....  | \$803/pr. (L1)           |
| (Pre-assembled) <sup>OS1</sup> .....                      | <b>DO68GKD0012(C)-PA</b> |
| 100G, 220G .....  | \$635/pr.                |
| 333G, 502G, 709G .....                                    | \$667/pr. (L4)           |
| 135G .....  | \$1129/pr. (L1)          |
| ☞ Please specify carpet color at time of order.           |                          |
| <b>Sport Coupe Rear Panels</b>                            |                          |
| (Unassembled) .....                                       | <b>DO68GKD0048(C)</b>    |
| 100G, 220G .....  | \$333/pr.                |
| 333G, 502G, 709G .....                                    | \$350/pr. (L4)           |
| 135G .....  | \$387/pr. (L1)           |
| (Pre-assembled) <sup>OS1</sup> .....                      | <b>DO68GKD0048(C)-PA</b> |
| 100G, 220G .....  | \$507/pr.                |
| 333G, 502G, 709G .....                                    | \$532/pr. (L4)           |
| 135G .....  | \$740/pr. (L1)           |
| ☞ Customer must provide upper rails.                      |                          |
| <b>Convertible Rear Panels</b>                            |                          |
| (Unassembled) .....                                       | <b>DO68GKD0056(C)</b>    |
| 100G, 220G .....  | \$333/pr.                |
| 333G, 502G, 709G .....                                    | \$350/pr. (L4)           |
| 135G .....  | \$387/pr. (L1)           |
| (Pre-assembled) <sup>OS1</sup> .....                      | <b>DO68GKD0056(C)-PA</b> |
| 100G, 220G .....  | \$507/pr.                |
| 333G, 502G, 709G .....                                    | \$532/pr. (L4)           |
| 135G .....  | \$740/pr. (L1)           |
| ☞ Customer must provide upper rails.                      |                          |
| <b>Sport Coupe Armrest/Well Covers...AW68GA00048(C)</b>   |                          |
| 100G, 220G .....  | \$82/pr.                 |
| 333G, 502G, 709G .....                                    | \$86/pr. (L4)            |
| 135G .....  | \$183/pr. (L1)           |
| <b>Convertible Armrest/Well Covers.....AW68GA00056(C)</b> |                          |
| 100G, 220G .....  | \$101/pr.                |
| 333G, 502G, 709G .....                                    | \$106/pr. (L4)           |
| 135G .....  | \$225/pr. (L1)           |



**1969 SKYLARK & GRAN SPORT 350**



**(C) COLOR CODES:**  
 (100G) Black  
 (235G) Parchment  
 (325G) Light Metallic Blue

|  |                   |
|--|-------------------|
| Front Panels<br>(Unassembled) .....            | DO69GKS0012(C)    |
|  | \$482/pr.         |
| (Pre-assembled) <sup>OS1</sup> .....           | DO69GKS0012(C)-PA |
|  | \$635/pr.         |
| Sport Coupe Rear Panels<br>(Unassembled) ..... | DO69GKS0048(C)    |
|  | \$333/pr.         |
| (Pre-assembled) <sup>OS1</sup> .....           | DO69GKS0048(C)-PA |
|  | \$507/pr.         |

*This Legendary product features as-original Die-electrically heat sealed Madrid grain vinyl with double chrome accent bands. Special cutout area in filler board to accommodate armrest base. Padded Multi-Level Construction 3-Dimensional Panel.*  
**NOTE:** Customer must reuse original decorative trim and medallions. Medallions are available. See following section of catalog.

**1969 SKYLARK, SKYLARK CUSTOM, GRAN SPORT 350 & 400**

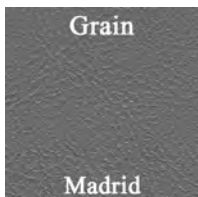

**(C) COLOR CODES:**  
 (100G) Black  
 (239G) Metallic Parchment  
 (235G) Parchment  
 (325G) Metallic Blue  
 (450G) Metallic Green  
 (503G) Red  
 (710G) Buckskin

*This Legendary product features as-original Die-electrically heat sealed Madrid grain vinyl with chrome accent belt and carpeted lower section. Special cutout area in filler board to accommodate armrest base. Padded Multi-Level Construction 3-Dimensional Panel.*  
**NOTE:** Customer must reuse original decorative trim and medallions. Medallions are available. See following section of catalog.

|   |                                  |
|---|----------------------------------|
| Front Panels<br>(Unassembled) .....   | DO69GKD0012(C)                   |
| 100G, 239G, 240G, 325G .....  | \$482/pr.                        |
| 503G, 710G .....  | \$506/pr. (L4)                   |
| 450G .....  | \$803/pr. (L1)                   |
| (Pre-assembled) .....   | DO69GKD0012(C)-PA <sup>OS1</sup> |
| 100G, 239G, 240G, 325G .....  | \$635/pr.                        |
| 503G, 710G .....  | \$667/pr. (L4)                   |
| 450G .....  | \$1129/pr. (L1)                  |
| <sup>OS1</sup> Includes original style upper metal rail, door lock ferrules & windowfelt strip. |                                  |
| <sup>OS1</sup> Please specify carpet color.   |                                  |
| <sup>OS1</sup> 450G Metallic Green uses special run material.                                   |                                  |
| Sport Coupe Rear Panels<br>(Unassembled) .....  | DO69GKD0048(C)                   |
| 100G, 239G, 325G .....  | \$333/pr.                        |
| 710G .....  | \$350/pr. (L4)                   |
| 450G .....  | \$387/pr. (L1)                   |
| (Pre-assembled) .....   | DO69GKD0048(C)-PA <sup>OS1</sup> |
| 100G, 239G, 325G .....  | \$507/pr.                        |
| 710G .....  | \$532/pr. (L4)                   |
| 450G .....  | \$740/pr. (L1)                   |
| <sup>OS1</sup> Customer must provide upper rails.   |                                  |
| <sup>OS1</sup> 450G Metallic Green uses special run material.                                   |                                  |
| Convertible Rear Panels<br>(Unassembled) .....  | DO69GKD0056(C)                   |
| 100G, 239G, 240G, 325G .....  | \$333/pr.                        |
| 503G, 710G .....  | \$350/pr. (L4)                   |
| (Pre-assembled) .....   | DO69GKD0056(C)-PA <sup>OS1</sup> |
| 100G, 239G, 240G, 325G .....  | \$507/pr.                        |
| 503G, 710G .....  | \$532/pr. (L4)                   |
| <sup>OS1</sup> Customer must provide upper rails.   |                                  |
| Sport Coupe Armrest/Well Covers<br>.....  | AW68GA00048(C)                   |
| 100G, 239G, 325G .....  | \$82/pr.                         |
| 710G .....  | \$86/pr. (L4)                    |
| 450G .....  | \$183/pr. (L1)                   |
| <sup>OS1</sup> 450G Metallic Green uses special run material.                                   |                                  |
| Convertible Armrest/Well Covers<br>.....  | AW68GA00056(C)                   |
| 100G, 239G, 240G, 343G, 640G .....  | \$101/pr.                        |
| 503G .....  | \$106/pr. (L4)                   |

## 1970 SKYLARK, GRAN SPORT & GRAN SPORT 455

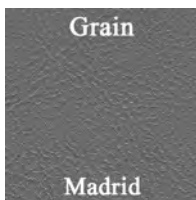

**(C) COLOR CODES:**

- (100G) Black
- (316G) Dark Met. Blue / Light Met. Blue
- (691G) Dark Sandalwood/Sandalwood

|  |                   |
|--|-------------------|
| Front Panels<br>(Unassembled) .....                    | DO70GKD0020(C)    |
| .....  | \$482/pr.         |
| (Pre-assembled) <sup>OS1</sup> .....                   | DO70GKD0020(C)-PA |
| .....  | \$635/pr.         |
| Sport Coupe Rear Panels<br>(Unassembled) .....         | DO70GKD0080(C)    |
| .....  | \$333/pr.         |
| (Pre-assembled) <sup>OS1</sup> .....                   | DO70GKD0080(C)-PA |
| .....  | \$479/pr          |
| Sport Coupe Armrest/Well Covers<br>(Unassembled) ..... | AW68GA00048(C)    |
| .....  | \$82/pr.          |

*This Legendary product features as-original Die-electrically Madrid grain vinyl with chrome accent band and chrome accent well. Special cutout area in filler board to accommodate armrest base. Padded Multi-Level Construction 3-Dimensional Panel.*  
 NOTE: Customer must reuse original decorative trim and medallions. Medallions are available. See following section of catalog.

## 1970 SKYLARK, SKYLARK CUSTOM, GS & GS 455



**(C) COLOR CODES:**

- (100G) Black
- (202G) Pearl White
- (342G) Dark Metallic Blue
- (460G) Metallic Green
- (658G) Burnished Saddle
- (683G) Saddle
- (694G) Sandalwood

|  |                   |
|--|-------------------|
| Front Panels<br>(Unassembled) .....                    | DO70GK00012(C)    |
| .....  | \$482/pr.         |
| (Pre-assembled) <sup>OS1</sup> .....                   | DO70GK00012(C)-PA |
| .....  | \$635/pr.         |
| Sport Coupe Rear Panels<br>(Unassembled) .....         | DO70GK00048(C)    |
| .....  | \$333/pr.         |
| (Pre-assembled) <sup>OS1</sup> .....                   | DO70GK00048(C)-PA |
| .....  | \$479/pr.         |
| Sport Coupe Armrest/Well Covers<br>(Unassembled) ..... | AW68GA00048(C)    |
| .....  | \$82/pr.          |
| Convertible Rear Panels<br>(Unassembled) .....         | DO70GK00056(C)    |
| .....  | \$333/pr.         |
| (Pre-assembled) <sup>OS1</sup> .....                   | DO70GK00056(C)-PA |
| .....  | \$479/pr          |
| Convertible Armrest/Well Covers<br>(Unassembled) ..... | AW68GA00056(C)    |
| .....  | \$101/pr.         |

*This Legendary product features as-original Die-electrically heat sealed Madrid grain vinyl with Diamond Waffle grain inserts and double-stitched accent belts. Special cutout area in filler board to accommodate armrest base. Padded Multi-Level Construction 3-Dimensional Panel.*

NOTE: Customer must reuse original decorative trim and medallions. Medallions are available. See following section of catalog.



## 1971 SKYLARK, SKYLARK CUSTOM & GRAN SPORT



**(C) COLOR CODES:**

- (100G) Black
- (202G) Pearl White
- (468G) Green
- (690G) Saddle
- (697G) Sandalwood

This Legendary product features as-original Die-electrically heat sealed Madrid grain vinyl with Roulet grain insert and double-stitched accent belts. Special cutout area in filler board to accommodate armrest base. Padded Multi-Level Construction 3-Dimensional Panel.

NOTE: Customer must reuse original decorative trim and medallions. Medallions are available. See following section of catalog.

|  |                          |
|--|--------------------------|
| <b>Front Panels</b>                    |                          |
| (Unassembled) .....                    | <b>DO71GKS0012(C)</b>    |
| 100G, 202G, 690G .....                 | \$482/pr.                |
| 468G, 697G .....                       | \$506/pr. (L4)           |
| (Pre-assembled) <sup>OS1</sup> .....   | <b>DO71GKS0012(C)-PA</b> |
| 100G, 202G, 690G .....                 | \$635/pr.                |
| 468G, 697G .....                       | \$667/pr. (L4)           |
| <b>Sport Coupe Rear Panels</b>         |                          |
| (Unassembled) .....                    | <b>DO71GKS0048(C)</b>    |
| 100G, 202G, 690G .....                 | \$333/pr.                |
| 468G, 697G .....                       | \$350/pr. (L4)           |
| (Pre-assembled) <sup>OS1</sup> .....   | <b>DO71GKS0048(C)-PA</b> |
| 100G, 202G, 690G .....                 | \$479/pr.                |
| 468G, 697G .....                       | \$503/pr. (L4)           |
| <b>Sport Coupe Armrest/Well Covers</b> |                          |
| .....                                  | <b>AW68GA00048(C)</b>    |
| 100G, 202G, 690G .....                 | \$82/pr.                 |
| 468G, 697G .....                       | \$86/pr. (L4)            |
| <b>Convertible Rear Panels</b>         |                          |
| (Unassembled) .....                    | <b>DO71GKS0056(C)</b>    |
| 100G, 202G, 690G .....                 | \$333/pr.                |
| 468G, 697G .....                       | \$350/pr. (L4)           |
| (Pre-assembled) <sup>OS1</sup> .....   | <b>DO71GKS0056(C)-PA</b> |
| 100G, 202G, 690G .....                 | \$479/pr.                |
| 468G, 697G .....                       | \$503/pr. (L4)           |
| <b>Convertible Armrest/Well Covers</b> |                          |
| .....                                  | <b>AW68GA00056(C)</b>    |
| 100G, 202G, 690G .....                 | \$101/pr.                |
| 468G, 697G .....                       | \$106/pr. (L4)           |

## 1971 SKYLARK & GRAN SPORT



**(C) COLOR CODES:**

- (100G) Black
- (468G) Green
- (697G) Sandalwood

This Legendary product features as-original Die-electrically heat sealed Madrid grain vinyl with chrome accent strip. Special cutout area in filler board to accommodate armrest base. Padded Multi-Level Construction 3-Dimensional Panel.

NOTE: Customer must reuse original decorative trim and medallions. Medallions are available. See following section of catalog.

|  |                          |
|--|--------------------------|
| <b>Sport Coupe Front Panels</b>        |                          |
| (Unassembled) .....                    | <b>DO71GKS0028(C)</b>    |
| 100G .....                             | \$482/pr.                |
| 468G, 697G .....                       | \$506/pr. (L4)           |
| (Pre-assembled) <sup>OS1</sup> .....   | <b>DO71GKS0028(C)-PA</b> |
| 100G .....                             | \$635/pr.                |
| 468G, 697G .....                       | \$667/pr. (L4)           |
| <b>Coupe Front Panels</b>              |                          |
| (Unassembled) .....                    | <b>DO71GKS0020(C)</b>    |
| 100G .....                             | \$482/pr.                |
| 468G, 697G .....                       | \$506/pr. (L4)           |
| (Pre-assembled) <sup>OS1</sup> .....   | <b>DO71GKS0020(C)-PA</b> |
| 100G .....                             | \$670/pr.                |
| 468G, 697G .....                       | \$704/pr. (L4)           |
| <b>Sport Coupe Rear Panels</b>         |                          |
| (Unassembled) .....                    | <b>DO71GKS0080(C)</b>    |
| 100G .....                             | \$333/pr.                |
| 468G, 697G .....                       | \$350/pr. (L4)           |
| (Pre-assembled) <sup>OS1</sup> .....   | <b>DO71GKS0080(C)-PA</b> |
| 100G .....                             | \$479/pr.                |
| 468G, 697G .....                       | \$503/pr. (L4)           |
| <b>Coupe Rear Panels</b>               |                          |
| (Unassembled) .....                    | <b>DO71GKS0088(C)</b>    |
| 100G .....                             | \$333/pr.                |
| 468G, 697G .....                       | \$350/pr. (L4)           |
| (Pre-assembled) <sup>OS1</sup> .....   | <b>DO71GKS0088(C)-PA</b> |
| 100G .....                             | \$507/pr.                |
| 468G, 697G .....                       | \$532/pr. (L4)           |
| <b>Sport Coupe Armrest/Well Covers</b> |                          |
| (Unassembled) .....                    | <b>AW68GA00048(C)</b>    |
| 100G .....                             | \$82/pr.                 |
| 468G, 697G .....                       | \$86/pr. (L4)            |

# 1972 SKYLARK CUSTOM & GRAN SPORT



**(C) COLOR CODES:**  
 (100G) Black  
 (230G) White  
 (465G) Green  
 (690G) Saddle

|   |                          |
|---|--------------------------|
| Front Panels<br>(Unassembled).....            | <b>DO71GKS0012(C)</b>    |
| 100G, 230G, 690G ..                           | \$482/pr.                |
| 465G.....                                     | \$506/pr. (L4)           |
| (Pre-assembled)...                            | <b>DO71GKS0012(C)-PA</b> |
| 100G, 230G, 690G ..                           | \$635/pr.                |
| 465G.....                                     | \$667/pr. (L4)           |
| Convertible Rear Panels<br>(Unassembled)..... | <b>DO71GKS0056(C)</b>    |
| 100G, 230G, 690G ..                           | \$333/pr.                |
| 465G.....                                     | \$350/pr. (L4)           |
| Convertible Rear Panels<br>(Pre-assembled)... | <b>DO71GKS0056(C)-PA</b> |
| 100G, 230G, 690G ..                           | \$479/pr.                |
| 465G.....                                     | \$503/pr. (L4)           |
| Convertible Armrest/Well Covers<br>.....      | <b>AW68GA00056(C)</b>    |
| 100G, 230G, 690G ..                           | \$101/pr.                |
| 465G.....                                     | \$106/pr. (L4)           |

This Legendary product features as-original Die-electrically heat sealed Madrid grain vinyl with Roulet grain inserts and double-stitched accent belts. Special cutout area in filler board to accommodate armrest base. Padded Multi-Level Construction 3-Dimensional Panel.

NOTE: Customer must reuse original decorative trim and medallions. Medallions are available. See following section of catalog.

# 1972 SKYLARK & GRAN SPORT

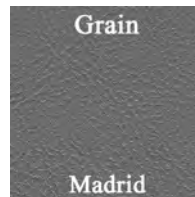

**(C) COLOR CODES:**  
 (100G) Black  
 (465G) Green  
 (690G) Saddle

|  |                          |
|--|--------------------------|
| Sport Coupe Front Panels<br>(Unassembled)..... | <b>DO71GKS0028(C)</b>    |
| 100G, 690G.....                                | \$482/pr.                |
| 465G.....                                      | \$506/pr. (L4)           |
| (Pre-assembled) <sup>OS1</sup> .....           | <b>DO71GKS0028(C)-PA</b> |
| 100G, 690G.....                                | \$635/pr.                |
| 465G.....                                      | \$667/pr. (L4)           |
| Coupe Front Panels<br>(Unassembled).....       | <b>DO71GKS0020(C)</b>    |
| 100G, 690G.....                                | \$482/pr.                |
| 465G.....                                      | \$506/pr. (L4)           |
| (Pre-assembled) <sup>OS1</sup> .....           | <b>DO71GKS0020(C)-PA</b> |
| 100G, 690G.....                                | \$670/pr.                |
| 465G.....                                      | \$704/pr. (L4)           |
| Sport Coupe Rear Panels<br>(Unassembled).....  | <b>DO71GKS0080(C)</b>    |
| 100G, 690G.....                                | \$333/pr.                |
| 465G.....                                      | \$350/pr. (L4)           |
| (Pre-assembled) <sup>OS1</sup> .....           | <b>DO71GKS0080(C)-PA</b> |
| 100G, 690G.....                                | \$479/pr.                |
| 465G.....                                      | \$503/pr. (L4)           |
| Coupe Rear Panels<br>(Unassembled).....        | <b>DO71GKS0088(C)</b>    |
| 100G, 690G.....                                | \$333/pr.                |
| 465G.....                                      | \$350/pr. (L4)           |
| (Pre-assembled) <sup>OS1</sup> .....           | <b>DO71GKS0088(C)-PA</b> |
| 100G, 690G.....                                | \$507/pr.                |
| 465G.....                                      | \$532/pr. (L4)           |
| Sport Coupe Armrest/Well Covers<br>.....       | <b>AW68GA00048(C)</b>    |
| 100G, 690G.....                                | \$82/pr.                 |
| 465G.....                                      | \$86/pr. (L4)            |

This Legendary product features as-original Die-electrically heat sealed Madrid grain vinyl with chrome accent strip. Special cutout area in filler board to accommodate armrest base. Padded Multi-Level Construction 3-Dimensional Panel.

NOTE: Customer must reuse original decorative trim and medallions. Medallions are available. See following section of catalog.



**1972 SKYLARK, SKYLARK CUSTOM & GRAN SPORT**



**(C) COLOR CODES:**

- (100G) Black
- (230G) White
- (670G) Tan
- (690G) Saddle
- (695G) NOS Sandalwood

*This Legendary product features as-original Die-electrically heat sealed Madrid grain vinyl with woodgrain center insert and carpeted lower section. Special cutout area in filler board to accommodate armrest base.*

*Padded Multi-Level Construction 3-Dimensional Panel.*

*NOTE: Customer must reuse original decorative trim and medallions. Medallions are available.*

*See following section of catalog.*

|                                      |                          |
|--------------------------------------|--------------------------|
| Front Panels<br>(Unassembled) .....  | <b>DO72GKD0012(C)</b>    |
| 100G, 230G, 690G .....               | \$551/pr.                |
| 670G .....                           | \$579/pr. <b>(L4)</b>    |
| 695G .....                           | \$901/pr. <b>(L1)</b>    |
| (Pre-assembled) <sup>951</sup> ..... | <b>DO72GKD0012(C)-PA</b> |
| 100G, 230G, 690G .....               | \$728/pr.                |
| 670G .....                           | \$764/pr. <b>(L4)</b>    |
| 695G .....                           | \$1141/pr. <b>(L1)</b>   |

*Please refer to carpet color selection page to specify carpet color at time of order.*

*Customer must reuse original metal trim.*

|  |                          |
|--|--------------------------|
| Sport Coupe Rear Panels<br>(Unassembled) ..... | <b>DO72GKD0048(C)</b>    |
| 100G, 230G, 690G .....                         | \$290/pr.                |
| 670G .....                                     | \$305/pr. <b>(L4)</b>    |
| 695G .....                                     | \$479/pr. <b>(L1)</b>    |
| (Pre-assembled) <sup>951</sup> .....           | <b>DO72GKD0048(C)-PA</b> |
| 100G, 230G, 690G .....                         | \$520/pr.                |
| 670G .....                                     | \$546/pr. <b>(L4)</b>    |
| 695G .....                                     | \$681/pr. <b>(L1)</b>    |

*Customer must reuse original metal trim.*

|  |                       |
|--|-----------------------|
| Sport Coupe Armrest/Well Covers<br>..... | <b>AW68GA00048(C)</b> |
| 100G, 230G, 690G .....                   | \$82/pr.              |
| 670G .....                               | \$86/pr. <b>(L4)</b>  |
| 695G .....                               | \$183/pr. <b>(L1)</b> |



\*\*\*

Providing the automotive industry  
with the world's highest quality  
soft trim products and services  
RIGHT HERE AT HOME

\*\*\*

STILL ASSEMBLED AND  
MADE IN THE ★★★★★  
**USA** 

\*\*\*

THERE REALLY IS A DIFFERENCE!!

\*\*\*

*Legendary*  
**AUTO INTERIORS LTD.**

[www.legendaryautointeriors.com](http://www.legendaryautointeriors.com)



## 1964-72 ARMREST PADS

Reproduction molded armrest pads are manufactured in the correct grains and texture as the originals. 1964 pads feature Seville grain, while 1965-72 feature authentic Madrid grain. For colors other than black, please specify at time of order.

### 1964-72 FRONT PADS



#### 1964-67 Skylark & Gran Sport (Coupe)

##### AP64GA-FRT (1964)

100G, 220G, 325G, 334G, 405G, 508G, 656G .....\$105.00/pr.

##### AP65GA-FRT (1965-67)

100G, 220G, 310G, 325G, 343G, 420G, 448G, 501G, 520G, 640G, 650G .....\$105.00/pr.  
679G .....\$149.00/pr. (L1)

☞ These pads measure 11" in length.

☞ Please refer to door panel section for available colors.

#### 1968-72 Skylark & Gran Sport

##### AP68GA-FRT

100G, 202G, 230G, 235G, 239G, 325G, 333G, 342G, 460G, 502G, 503G, 658G, 670G, 683G, 690G, 694G, 695G, 697G, 709G, 135G .....\$149.00/ea. (L4)

☞ These pads measure 11" in length.

☞ Please refer to door panel section for available colors.

#### 1968-70 Skylark & Gran Sport

##### AP68GKU-FRT01 (Black)

.....\$159.00/pr.  
☞ These pads measure 16" in length.  
☞ Available in black only.

### 1964-69 REAR PADS



#### 1964 Skylark & Gran Sport (Coupe)

##### AP64GA-RR

100G, 220G, 325G, 334G, 405G, 508G, 656G .....\$105.00/pr.  
☞ Please refer to door panel section for available colors.  
☞ Sport Coupe & Coupe models only.

#### 1965 Skylark & Gran Sport (Coupe)

##### AP65GA-RR

100G, 220G, 240G, 310G, 325G, 343G, 420G, 448G, 501G, 520G, 640G, 650G, 679G .....\$105.00/pr.  
679G .....\$149.00/pr. (L1)

☞ Coupe models only.

#### 1968-69 Skylark & Gran Sport (Coupe)

##### AP68GA-RR

100G, 220G, 235G, 239G, 325G, 333G, 502G, 503G, 658G, 709G, 710G .....\$95.00/ea.  
135G .....\$149.00/ea. (L4)

☞ Please refer to door panel section for available colors.

☞ Sport Coupe & Coupe models only.

## 1964-72 REAR ARMREST COVERS

Rear armrest covers for Holiday Coupe, Hard-top Coupe and Convertible models are made in-house to original specifications and feature the correct vinyl colors and grains to match our upholstery. Please specify color at time of order.



### COUPE MODELS

#### 1964 Skylark

AW64GA00048(C) .....\$82.00-\$86.00/set

☞ Please see door panel section for available colors.

#### 1965-67 Skylark & Gran Sport

AW65GA00048(C) .....\$82.00-\$86.00/set

☞ Please see door panel section for available colors.

#### 1968-72 Skylark & Gran Sport

AW68GA00048(C) .....\$82.00-\$86.00/set

☞ Please see door panel section for available colors.

### CONVERTIBLE MODELS

#### 1964 Skylark

AW64GA00056(C) .....\$101.00-\$106.00/set

☞ Please see door panel section for available colors.

#### 1965 Skylark & Gran Sport

AW65GA00056(C) .....\$101.00-\$106.00/set

☞ Please see door panel section for available colors.

#### 1966-67 Skylark & Gran Sport

AW66GA00056(C) .....\$101.00-\$106.00/set

☞ Please see door panel section for available colors.

#### 1968-72 Skylark & Gran Sport

AW68GA00056(C) .....\$101.00-\$106.00/set

☞ Please see door panel section for available colors.

## 1964-67 ARMREST BASES

Chrome armrest bases are original-style injection molded plastic. Triple chrome plated, these are of a superior quality than others on the market. Available in pairs for both front and rear.



#### 1964-65 Skylark & Gran Sport (Coupe)

AP64GA-BASEFRT (Front) (shown) ....\$49.00/pr.

☞ Uses 11" armrest pads.

#### 1964-65 Skylark & Gran Sport (Coupe)

AP64GA-BASERR (Rear).....\$49.00/pr.

☞ Fits all coupe models.

## 1968-72 ARMREST BASES

High-quality reproduction injection molded plastic bases have the original texture and grain as the originals.



#### 1968-72 Skylark & Gran Sport

AP68GAF-BASELH (Left Front) .....\$29.00/ea.

AP68GAF-BASERH (Right Front) .....\$29.00/ea.

☞ Measure 11" in length.

☞ Use with 11" armrest pads.

## 1969-72 ARMREST BASE CHROME BACK PLATE

Chrome back plates found on some, but not all, 1969-72 models. Factory exact and ready to install. Will not work for 1968 models.



#### 1969-72 Skylark & Gran Sport

AP69GA-BASECHR (Front) .....\$49.00/pr.

☞ Use with 11" armrest bases shown above.

## 1968-72 ARMREST BASE SCREW SET

These Phillips head sheet metal screws fasten the armrest base to the door. Set of (6).

#### 1968-72 Skylark & Gran Sport

AP68GA-SCREW (Set/6) .....\$10.00/set

**ASHWELL INSTALLATION PAD KITS**

Ashwell installation pad kits for 1964-72 Skylark & GS Hardtop and Convertible models.



**1964-67 Skylark & GS (hardtop)**  
**INSTALLATION-AW1**.....\$39.00/kit  
 ⚙️ Kit includes: (2) 20oz. board w/ 5oz. felt attached,  
 (2) 20oz. felt & (2) 40oz. felt



**1968-72 Skylark & GS (hardtop)**  
**INSTALLATION-AW3**.....\$39.00/kit  
 ⚙️ Kit includes: (2) 20oz. board w/ 5oz. felt attached,  
 (2) 20oz. felt & (2) 40oz. felt

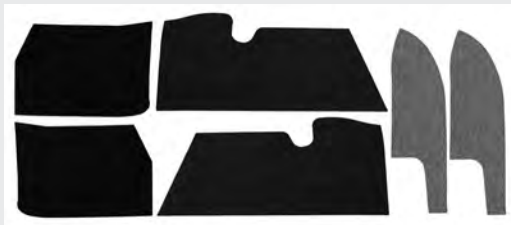

**1964-67 Skylark & GS (convertible)**  
**INSTALLATION-AW2**.....\$39.00/kit  
 ⚙️ Kit includes: (2) 20oz. board w/ 5oz. felt attached,  
 (2) 5oz. felt & (2) 20oz. felt



**1968-72 Skylark & GS (convertible)**  
**INSTALLATION-AW4**.....\$39.00/kit  
 ⚙️ Kit includes: (2) 20oz. board w/ 5oz. felt attached,  
 (2) 5oz. felt & (2) 20oz. felt

**1964-72 CONVERTIBLE COURTESY LIGHT LENS & BEZELS**



These quality reproduction lens and bezels mount to the rear armrest on convertible models. The lens is reproduced in the correct "eggshell" white while the bezel is manufactured using NOS tooling.

**1964-72 Skylark & Gran Sport**  
**LL64GA-CBEZEL** (Bezel only).....\$35.00/ea.  
**LL64GA-CLENS** (Lens only).....\$10.00/ea.

**1964-72 ASHTRAYS**

These ashtrays are constructed from stainless steel and fit just like the originals. Available for both hardtop and convertible models.



**1964-67 Skylark & Gran Sport**  
**AT64GA-C** (Hardtop/Convertible) .....\$59.00/pr.  
 ⚙️ Bezels included for convertible models.

**1968-69 Skylark & Gran Sport Hardtop**  
**1968-70 Skylark & Gran Sport Coupe**  
**1968-70 Skylark & Gran Sport Convertible**  
**AT68GA-C** (Convertible) .....\$49.00/ea.

**1970 Skylark & Gran Sport Hardtop**  
**1971-72 Skylark & Gran Sport Hardtop/Coupe & Convertible**  
**AT68GA-H** (Hardtop) .....\$59.00/ea.

**HINGE TO DOOR BOLTS**



Made to exact GM specifications for proper fit.

**1968-72 Skylark & Gran Sport**  
**DO68GA-BOLTS**.....\$49.00/set

**1968-69 STAINLESS ARMREST BASE MOLDING**

Factory-correct armrest molding found on some, but not all 1968-69 models.

**1968-69 Skylark & Gran Sport**  
**AP68GA-BASETRIM** .....\$49.00/pr.  
 ⚙️ Holes will need to be drilled on bases for installation.



## 1968-69 DOOR PANEL WINDLACE



Made as original with Madrid grain vinyl, rubber cord and die-cut panel board. This windlace installs on the front edge of the rear quarter panels and is a decorative and functional wind seal. Made as original for both post, non-post and convertible models. Please specify color at time of order.



**1968-69 Skylark & Gran Sport**  
**WI68GA00047(C)** (Coupe) ..... \$98.00-\$103.00/pr.  
**WI68GA00048(C)** (Sport Cpe/Conv.) ..... \$98.00-\$103.00/pr.

## 1964-67 UPPER DOOR JAMB END CAPS

Exact reproduction endcaps screw to the upper door jamb and give that finished look by covering the end of the windlace seal. Available in black only.



**1964-65 Skylark & Gran Sport**  
**WI64GA-CAPH** (Coupe/Sport Coupe) .. \$39.00/pr.  
**WI64GA-CAPC** (Convertible)..... \$39.00/pr.

**1966-67 Skylark & Gran Sport**  
**WI66GA-CAPHC**..... \$29.00/pr.  
 ☞ Fits both hardtop and convertible models.

## 1964-67 DOOR JAMB WINDLACE



This quality replacement molded windlace features the original bumpy grain vinyl with the steel insert to clip to the door jamb edge lip. Available in black, lt. blue, dk. blue, fawn, saddle, (64) red, (65-67) red and white. Please specify color at time of order.

**1964-67 Skylark & Gran Sport**  
**WI64GA(C)** (Coupe models) ..... \$49.00/pr.  
 ☞ Will also work for convertible models.

## DOOR LOCK KNOBS



Complete your door trim restoration with new door lock knobs. Available in black or chrome.

**1964-66 Skylark & Gran Sport**  
**BT64GA** (Chrome)..... \$15.00/pr.

**1967 Skylark & Gran Sport**  
**BT67GA** (Chrome w/ "tuliped" head).... \$15.00/pr.

**1968-72 Skylark & Gran Sport (shown)**  
**BT68GA** (Chrome w/ ribbed shaft)..... \$19.00/pr.

## DOOR LOCK FERRULES

Authentically reproduced ferrules support the door lock knob.



BT64GAFERRULE

BT68GAFERRULE

**1964-67 Skylark & Gran Sport**  
**BT64GAFERRULE** (Clear plastic) ..... \$9.00/pr.

**1968-72 Skylark & Gran Sport**  
**BT68GAFERRULE** (Stainless steel)..... \$2.00/ea.  
 ☞ These ferrules feature the correct inner felt ring as original.

## DOOR PANEL CLIPS



Original style door panel installation clips.

**1964-72 Skylark & Gran Sport**  
**DOGACLIPS** ..... \$14.00/kit  
 ☞ Kit includes 18 clips and 12 trim screws which are enough to install a pair of door and rear quarter panels.

## DOOR PANEL CLIP RETAINERS



Plastic retainers fit into the inner door and quarter panel frame to act as anchors for the metal door panel clips.

**1964-72 Skylark & Gran Sport**  
**DOGARETAIN** (Pkg/12) ..... \$11.00/pk.

## DOOR HANDLES



Chrome reproduction inner door handle for 1964 Coupe models that use an 11" armrest pad.

**1964 Skylark**  
**CK64GA-DOOR** .....\$29.00/ea.



Chrome reproduction inner door handle for 1964-67 Sport Coupe and Convertible models that use a 13 1/2" armrest pad.

**1964-67 Skylark & Gran Sport**  
**CK64GUK-DOOR** .....\$59.00/pr



Chrome reproduction inner door handle for 1965-67 Coupe models that use an 11" armrest pad.

**1965-67 Skylark & Gran Sport**  
**CK65GA-DOOR** .....\$21.00/ea.



Chrome reproduction inner door handles for 1968-72 models.

**1968-72 Skylark & Gran Sport (all models)**  
**CK68GA-DOORLH (Left)** .....\$21.00/ea.  
**CK68GA-DOORRH (Right)** .....\$21.00/ea.

## WINDOW CRANK HANDLES



Die-cast reproduction of the original front and rear window crank handle for all 1964 models.

**1964 Skylark**  
**CK64GA-WNDW (Black knob)** .....\$29.00/ea.



Die-cast reproduction of the original chrome front and rear window crank handle for all 1965-66 models.

**1965-66 Skylark & Gran Sport**  
**CK65GA-WNDW (Chrome knob)** .....\$19.00/ea.



Die-cast reproduction of the original chrome front and rear window crank handle for all 1967-72 models.

**1967-72 Skylark & Gran Sport**  
**CK67GA-WNDW01 (Black knob)** .....\$17.00/ea.  
**CK67GA-WNDW02 (Clear knob)** .....\$17.00/ea.

## 1964-67 VENT WINDOW HANDLES



Duplicated to exact GM specifications with a brilliant chrome finish. These die-cast vent handles come with roll pins and spring washers.

**1964-65 Skylark & Gran Sport**  
**CK64GA-VENTLH (Left)** .....\$29.00/ea.  
**CK64GA-VENTRH (Right)** .....\$29.00/ea.

**1966-67 Skylark & Gran Sport**  
**CK66GA-VENT** .....\$49.00/pr.

## 1968-72 VENT WINDOW CRANKS



Reproduction vent window cranks for all 1968 models and 1969-72 Coupe models with vent windows.

**1968-72 Skylark & Gran Sport**  
**CK68GA-VENT01 (Black)** .....\$19.00/ea.  
**CK68GA-VENT02 (Clear)** .....\$19.00/ea.

## DOOR & WINDOW HANDLE PLASTIC WASHER



Injection molded plastic washers protect the door panel from wear when door and window handles are being used.

**1964-72 Skylark & Gran Sport**  
**CK64GA-SPACER** .....\$3.00/ea.

## WINDOW HANDLES SPRINGS



This spring goes behind the window crank handle and plastic washer to prevent vibration and rattling.

**1964-72 Skylark & Gran Sport**  
**CK64GA-SPRING** .....\$3.00/ea.

## DOOR & WINDOW HANDLE RETAINING CLIP



**1964-72 Skylark & Gran Sport**  
**CK64GA-CLIP** .....\$1.00/ea.



## DOOR LOCK STRIKER



These door strikers feature the same hardened steel as the originals and should be used to replace damaged or fatigued originals.

**1964-72 Skylark & Gran Sport NEW!!!**  
**DO64GA-STRIKER**..... \$19.00/ea.

## UPPER DOOR HINGES



1966-67

These are OEM-quality hinges and are made to factory specifications. They are fantastic reproductions of the original hinges and they're completely assembled for easy installation.

**1966-67 Skylark & Gran Sport (shown) NEW!!!**  
**DO66GA-HINGEU**..... \$59.00/ea.

**1968-72 Skylark & Gran Sport NEW!!!**  
**DO68GA-HINGEU**..... \$89.00/ea.

## LOWER DOOR HINGES



1966-67

These are OEM-quality hinges and are made to factory specifications. They are fantastic reproductions of the original hinges and they're completely assembled for easy installation.

**1966-67 Skylark & Gran Sport NEW!!!**  
**DO66GA-HINGELP (passenger)** ..... \$79.00/ea.  
**DO66GA-HINGELD (driver)**..... \$79.00/ea.

**1968-72 Skylark & Gran Sport NEW!!!**  
**DO68GA-HINGELP (passenger)** ..... \$89.00/ea.  
**DO68GA-HINGELD (driver)**..... \$99.00/ea.

## LOWER DOOR HINGE PINS

Hardened shouldered pivot pins



1964-67

**1964-67 Skylark & Gran Sport NEW!!!**  
**DO64GA-HINGEPIN** ..... \$8.00/ea



**1968-72 Skylark & Gran Sport NEW!!!**  
**DO68GA-HINGEPIN** ..... \$10.00/ea

## LOWER DOOR SPRING



Direct replacement for missing or broken door hinge springs. Same size and spring rate as original part.

**1965-67 Skylark & Gran Sport NEW!!!**  
**DO65GA-SPRING**..... \$15.00/ea.

## DOOR PANEL EMBLEMS

Emblem is chromed and detailed just like the original for a factory look.



**1970 Gran Sport (Deluxe)**  
**DO70GK-EMBLEM**..... \$29.00/ea.



1968-72

**1970-72 Gran Sport**  
**DO71GK-EMBLEM**..... \$39.00/ea.  
 For 1970 GS models with standard interiors.  
 For All 1971-72 GS Models

## DOOR PANEL WATERSHIELDS

Die-cut watershields are designed to protect your door panels from moisture. Sold as a complete set of 4 for front and rear panels.

**1964-67 Skylark & Gran Sport**  
**DO64GAWATERH (Hardtop)** ..... \$37.00/set  
**DO64GAWATERC (Convertible)**..... \$37.00/set

**1968-72 Skylark & Gran Sport**  
**DO68GAWATERHS (1968-69 Sport Cpe)** .. \$37.00/set  
**DO68GAWATERH (1970-72 Sport Cpe)** .. \$37.00/set  
**DO68GAWATERS (1968-72 Coupe)**... \$37.00/set  
**DO68GAWATERC (Convertible)**..... \$37.00/set

## SEAT BELT BOLTS



1964-66 Chrome Plated      1964-66 Cad Plated      1967-72 Chrome Plated

The bolt heads are the factory-sized 13/16" and fit and function just like the originals and come in either a cad-plated or chrome finish.

**1964-72 Skylark & Gran Sport NEW!!!**  
**BA64GA-BOLT (Chrome)**..... \$15.00/ea.  
**BA64GA-BOLTC (Cad)**..... \$15.00/ea.  
**BA67GA-BOLT (Chrome)**..... \$15.00/ea.

## JUTE BACKING

This insulating material when placed between the floorpan and molded carpet enhances sound barrier protection from road noise and adds cushion to your carpet. Also helpful for insulating headliners, trunk areas and more.



36"x36" cut

**TA20OZFELT (20 oz.)**..... \$19.00/yd.  
**TA40OZFELT (40 oz.)**..... \$29.00/yd.

## DOOR SILL PLATES



Replace old scratched-up sill plates with a pair of these exact reproductions. Precision manufactured using the correct aluminum and anodized finish featuring the "Body by Fisher" tags.  
 \* Does not come with screws, must supply own.

**1964-67 Skylark & Gran Sport**  
**SP64GA** ..... \$79.00/pr.

**1968-72 Skylark & Gran Sport**  
**SP68GA** ..... \$99.00/pr.

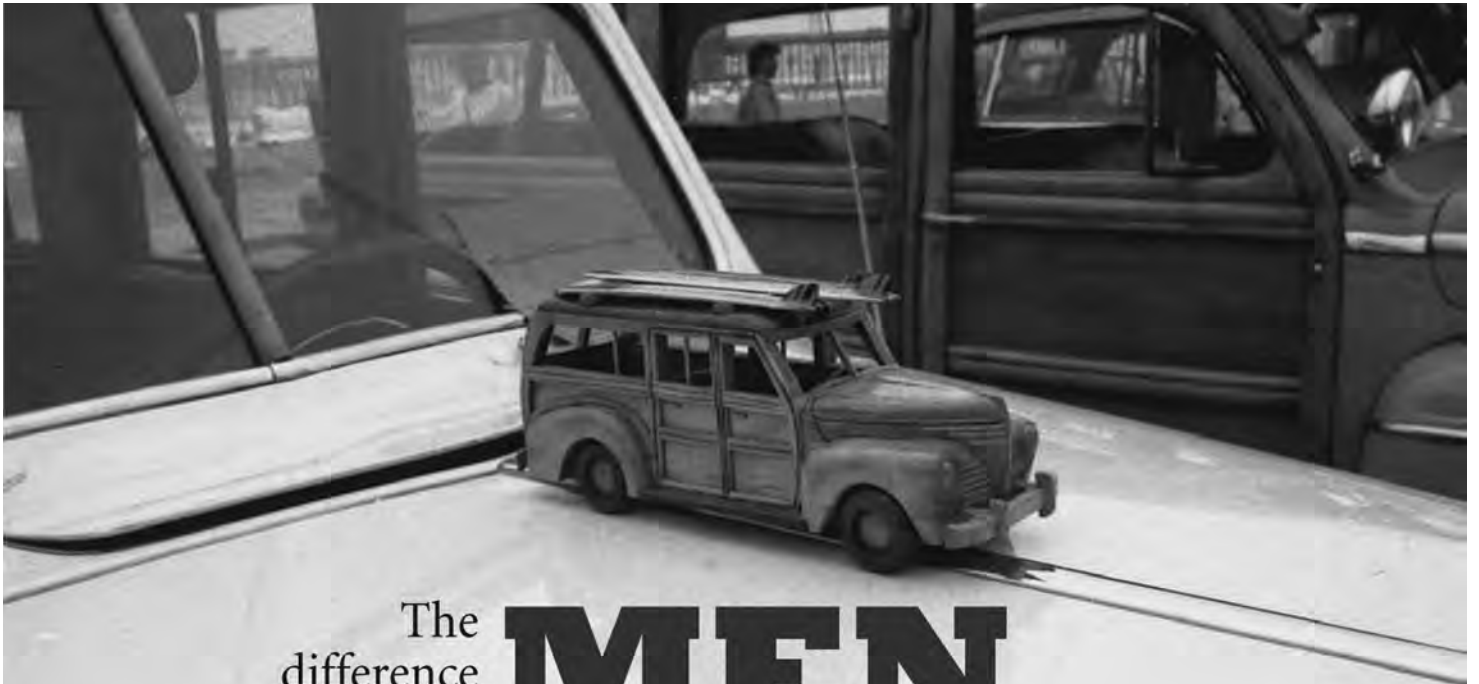

The  
difference  
between

# MEN

# & Boys

*is the size of  
their toys!*

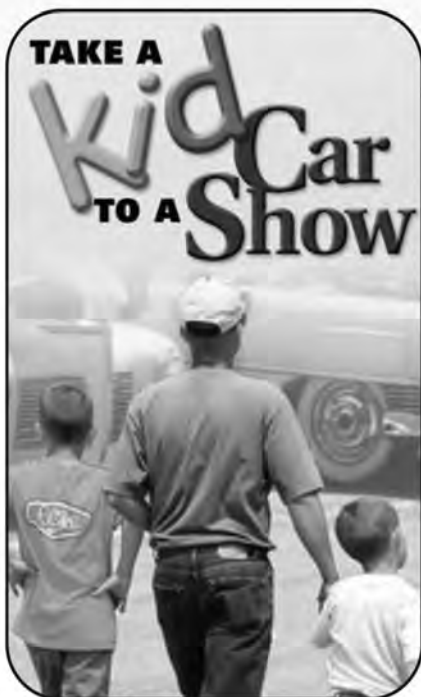

TAKE A  
**Kid Car**  
TO A  
**Show**

**E**ven if there is a generation or two between you and a child, collector cars can be a terrific common ground. Your enthusiasm and knowledge could be the spark of a new lifelong passion. Bring kids to *your* playground...a car show...and have fun.

**Life is full of choices for kids.** You can help them make the right ones by sharing your appreciation for cool old cars. (And a kid might even call you “cool” too!)





For more information and a list of  
upcoming automotive events, visit our website:  
**[www.TakeAKidToACarShow.com](http://www.TakeAKidToACarShow.com)**



909/396-0289 • [tkcs@sema.org](mailto:tkcs@sema.org)

Take a Kid to a Car Show is a program of ARMO, the Automotive Restoration Market Organization, a SEMA Council.



# CARPETS, FLOORMATS AND ACCESORIES

 [facebook.com/legendaryautointeriors](https://facebook.com/legendaryautointeriors)  
 [twitter.com/legendaryautoin](https://twitter.com/legendaryautoin)

 [www.legendaryautointeriors.com](http://www.legendaryautointeriors.com)  
 [instagram.com/legendaryautointeriorsltd](https://instagram.com/legendaryautointeriorsltd)  
 [youtube.com/user/legendaryauto](https://youtube.com/user/legendaryauto)



# MODEL SPECIFIC CARPET

Legendary brand molded carpets utilize the heaviest face weight cutpile and loop carpet combined with an extra heavy poly coated backing that provides for an accurate and sharply detailed mold formed area. Surged edges and accurately die cut and applied 40oz. felt underlayment is the finishing touch to our vehicle specific carpets.

## **Bound and Surged Edges**

Both Legendary cutpile and loop molded carpets have a heavy duty bound and surged edge that provides for an easy installation and clean appearance.



## **Underlayment Padding**

Legendary molded carpets are made with a 40 oz. felt underlayment padding. All padding is trimmed around seat track mounts, seat belt holes and covers the most area than any carpet in the industry!



# 80/20 Loop CARPET COLOR SELECTOR (c)

|                            |                          |                            |                          |                               |                           |                          |                            |
|----------------------------|--------------------------|----------------------------|--------------------------|-------------------------------|---------------------------|--------------------------|----------------------------|
| <b>01</b><br>BLACK         | <b>03</b><br>RED         | <b>04</b><br>AQUA          | <b>05</b><br>DARK TEAL   | <b>06</b><br>FORD BLUE        | <b>07</b><br>DARK BLUE    | <b>08</b><br>TEAL        | <b>09</b><br>SHADE 13 BLUE |
| <b>10</b><br>BRIGHT BLUE   | <b>11</b><br>MEDIUM BLUE | <b>12</b><br>GREEN         | <b>13</b><br>DARK GREEN  | <b>14</b><br>DARK OLIVE GREEN | <b>15</b><br>BLUE GREEN   | <b>16</b><br>MOSS GREEN  | <b>21</b><br>MEDIUM RED    |
| <b>22</b><br>BURNT ORANGE  | <b>24</b><br>ROSE BEIGE  | <b>25</b><br>DARK BROWN    | <b>26</b><br>SADDLE      | <b>27</b><br>LT/MEDIUM SADDLE | <b>28</b><br>DARK COPPER  | <b>29</b><br>DARK SADDLE | <b>31</b><br>MAROON        |
| <b>32</b><br>GOLD          | <b>33</b><br>DARK GOLD   | <b>34</b><br>FAWN          | <b>35</b><br>RED TUXEDO  | <b>36</b><br>BLUE TUXEDO      | <b>37</b><br>AQUA TUXEDO  | <b>38</b><br>LIGHT GREEN | <b>39</b><br>ORANGE        |
| <b>40</b><br>PLUM          | <b>41</b><br>SUNSET GLOW | <b>42</b><br>SILVER MINK   | <b>44</b><br>CORAL       | <b>45</b><br>EMBER GLOW       | <b>46</b><br>IVY GOLD     | <b>47</b><br>FAWN TUXEDO | <b>48</b><br>SILVER        |
| <b>49</b><br>GUNMETAL GRAY | <b>50</b><br>PARCHMENT   | <b>51</b><br>MIDNIGHT BLUE | <b>53</b><br>GOLD TUXEDO | <b>54</b><br>COPPER TUXEDO    | <b>55</b><br>OLIVE TUXEDO | <b>81</b><br>CHARCOAL    |                            |

**\*\*36oz. JUTE PADDING INCLUDED WHERE PADDING WAS ORIGINAL.**

**\*\*VINYL BOUND EDGE WHERE THE FRONT AND REAR SECTIONS OF THE CARPET OVERLAP.**

**\*\*COLOR MATCHED ORIGINAL HEEL PAD ACCURATELY APPLIED USING THE SAME METHOD AS OEM.**

**\*\*MEETS OR EXCEEDS OEM SPECIFICATIONS.**

**\*\*DIMMER SWITCH GROMMET INCLUDED.**

**\*\*COLOR SAMPLES ARE AVAILABLE FOR COLORS OTHER THAN BLACK.**

**\*\*DYE LOTS WILL VARY +/- 10%. THIS IS COMMON IN THE CARPET INDUSTRY. CUSTOMERS ARE ENCOURAGED TO ORDER ALL CARPETED PRODUCTS AT THE SAME TIME TO ENSURE MATCHING DYE LOT.**

**\*\*FOR YEARS AND MODELS NOT LISTED PLEASE CALL OUR SALES DEPARTMENT AT 800-363-8804**

## CARPET (NYLON LOOP)

The finest available today. Two-piece pre-molded shape made with an original specification blend of 100% Nylon. All carpets include 36oz. jute padding on the back-side, dimmer switch grommet, color matched original style heel pad and vinyl bound edge where the front and rear sections overlap. Carpet kits are not shipped with pre-cut holes. This must be done during installation of carpet. Some other minor trimming may be needed. For years and models not listed please call our sales department for more information. We are able to get carpet kits for many other Buick models and years not shown.

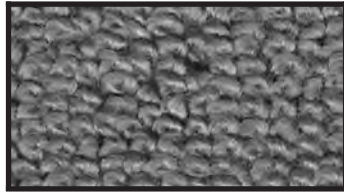

Loop Style

### 1964-67 Skylark & Gran Sport

**CA64GKA(C)** (2-door/Automatic).....\$205.00/ea.  
**CA64GKS(C)** (2-door/Manual).....\$205.00/ea.

### 1968-72 Skylark & Gran Sport (shown)

**CA68GKA(C)** (2-door/Automatic).....\$205.00/ea.  
**CA68GKS(C)** (2dr. Manual w/o console) ..\$205.00/ea.  
**CA68GKSW(C)** (2dr. Manual w/ console).....\$205.00/ea.

## KICK PANEL CARPET

Kick panel carpet kits made of nylon loop style carpeting and vinyl trim binding. Please specify with or without A/C, with or without fresh-air vent(s) and color of carpet and vinyl binding at time of order.



### 1964 Skylark (all models)

**KI64GAW/O(C)**  
 (with fresh air vents & no A/C)..... \$68.00/pr.  
**KI64GAW/AF(C)**  
 (with driverside fresh air vent & A/C)..... \$68.00/pr.

### 1964 Skylark (all models)

**KI64GAW/A(C)**  
 (with A/C & no fresh air vent)..... \$68.00/pr.

### 1965-66 Skylark & Gran Sport (all models)

**KI65GAW/O(C)**  
 (with fresh air vents & no A/C)..... \$68.00/pr.  
**KI65GAW/AF(C)**  
 (with driverside fresh air vent & A/C)..... \$68.00/pr.

### 1965-67 Skylark & Gran Sport (all models)

**KI65GAW/A(C)**  
 (with A/C & no fresh air vent)..... \$68.00/pr.

### 1967 Skylark & Gran Sport (all models)

**KI67GAW/O(C)**  
 (with fresh air vents & no A/C)..... \$68.00/pr.  
**KI67GAW/AF(C)**  
 (with driverside fresh air vent & A/C)..... \$68.00/pr.

### 1968 Skylark & Gran Sport (all models)

**KI68GAW/O(C)** (w/o A/C)..... \$68.00/pr.

### 1968-72 Skylark & Gran Sport (all models)

**KI68GAW/A(C)** (with A/C) (shown)..... \$68.00/pr.

### 1969-72 Skylark & Gran Sport (Sport Cpe. & Conv.)

**KI69GAW/O(C)** (w/o A/C)..... \$68.00/pr.

### 1969-72 Skylark & Gran Sport (Coupe)

**KI69GASW/O(C)** (w/o A/C)..... \$68.00/pr.

## CARPET YARDAGE

Need additional carpet?  
 We offer carpet yardage in 1yd. and 2yd. cuts. Please specify color at time of order. We highly recommend purchasing extra yardage along with your carpet kit to ensure color match.



### Loop Carpet

**CAYD(C)** (1 yard).....\$79.00/yd.  
 For colors other than black please refer to color code list located at the top of this page.

## KICK PANELS



Reproduction plastic kick panels made for models with factory air conditioning. These will also fit non-air conditioning models, but do not have the fresh-air outlet vents. Available in black only.

### 1964 Skylark

**KI64GA100**..... \$159.00/pr.

### 1965-66 Skylark & Gran Sport

**KI65GA100**..... \$159.00/pr.

### 1967 Skylark & Gran Sport

**KI67GA100** (shown)..... \$159.00/pr.

### 1968-72 Skylark & Gran Sport

**KI68GA100**..... \$149.00/pr.

## SOUND DEADENER

This heavyweight material installs under the carpet directly against the floorpan to reduce heat and noise. Pre-cut to correct shape and size.

### 1964-67 Skylark & Gran Sport

**SD64GA** .....\$99.00/ea.

### 1968-72 Skylark & Gran Sport

**SD68GA** .....\$99.00/ea.

## KICK PANEL INSULATION

Die-cut jute insulation pads fit between the plastic kick panel and the body sheet metal to protect from moisture.

### 1964-67 Skylark & Gran Sport

**KI64GA**..... \$17.00/pr.

### 1968-72 Skylark & Gran Sport

**KI68GA**..... \$17.00/pr.





\*\*\*

Providing the automotive industry  
with the world's highest quality  
soft trim products and services  
RIGHT HERE AT HOME

\*\*\*

**STILL ASSEMBLED AND  
MADE IN THE** ★★★★★  
**USA** 

\*\*\*

**THERE REALLY IS A DIFFERENCE!!**

\*\*\*

*Legendary*  
**AUTO INTERIORS LTD.®**

[www.legendaryautointeriors.com](http://www.legendaryautointeriors.com)





# LEGENDARY'S CUSTOM VINTAGE RUBBER STYLE FLOORMATS

## DESIGNED TO FIT WHOLE FLOORPAN OF CAR LOGOS ON FRONT AND REAR MATS

How many times have you wished for automotive floormats that have floorpan shapes, that are easily cleanable and also have that "factory original" styling that would make you proud to display them in your classic car? Our "Custom Vintage" rubber style floormats will please the most discriminating buyer and provide years of carefree use.



[www.legendaryautointeriors.com](http://www.legendaryautointeriors.com)

# CUSTOM DESIGN FLOORMATS

AVAILABLE IN ALL YEARS,  
MAKES AND MODELS

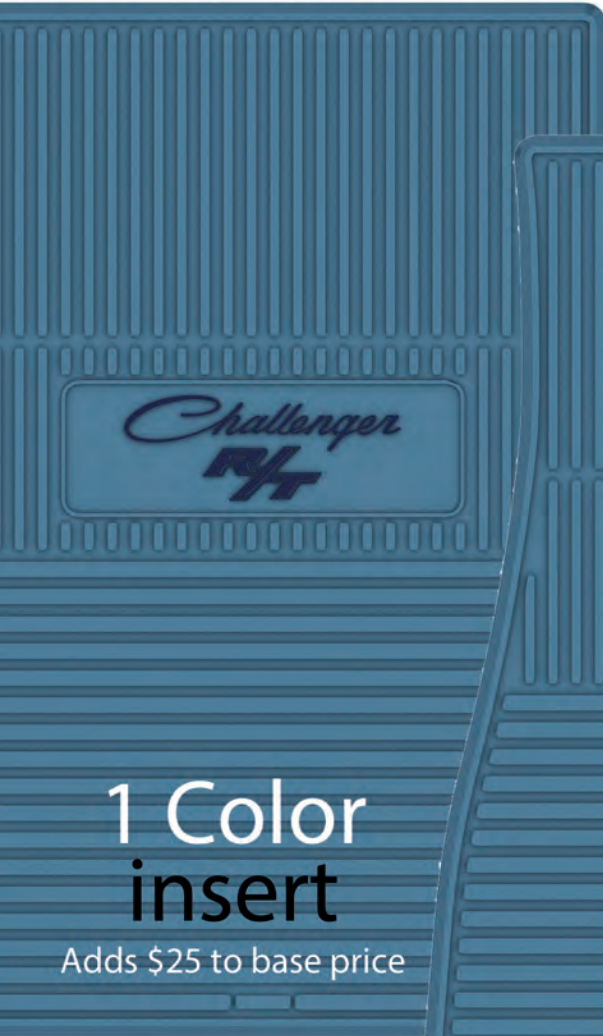

**1 Color  
insert**

Adds \$25 to base price

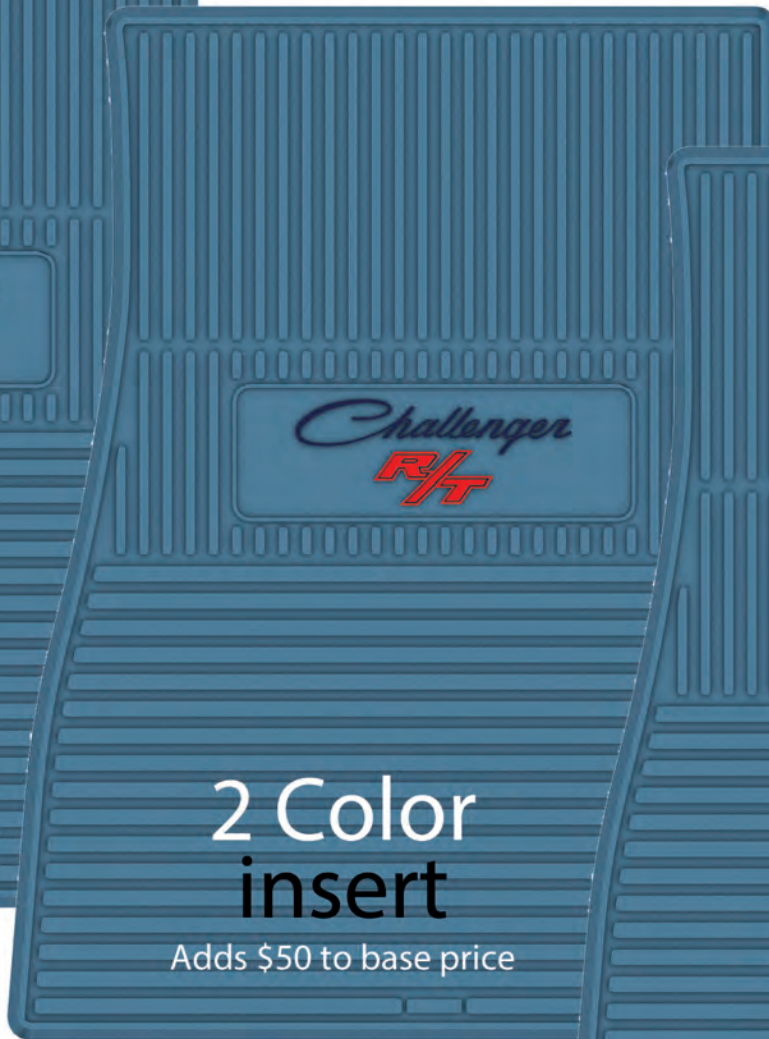

**2 Color  
insert**

Adds \$50 to base price

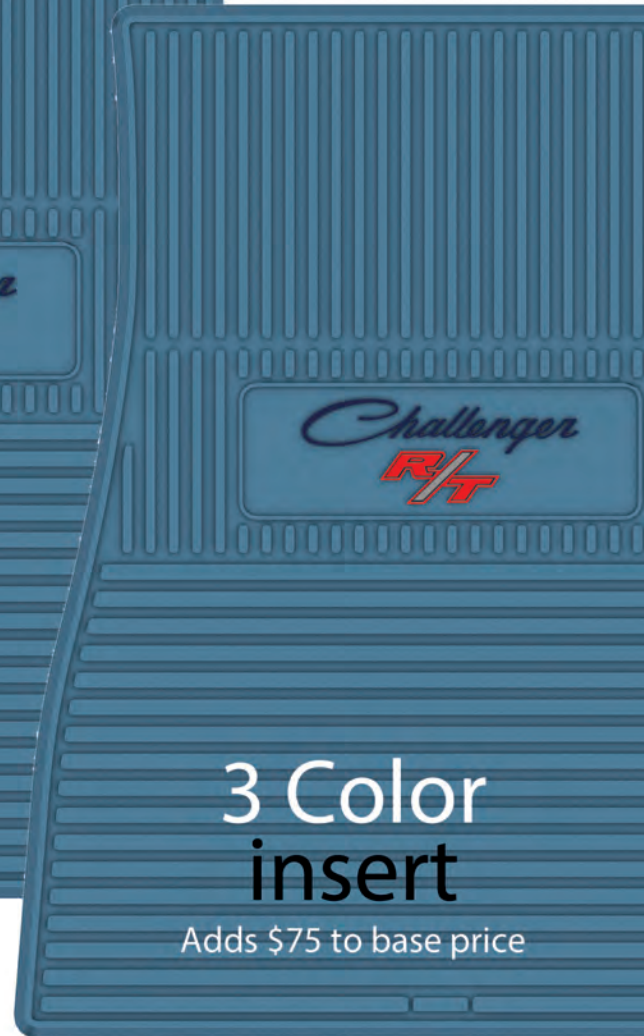

**3 Color  
insert**

Adds \$75 to base price

**DESIGN YOUR OWN  
INSERTS & COLORS**

[www.legendaryautointeriors.com](http://www.legendaryautointeriors.com)



# FLOORMAT BASE & INSERT COLORS

## BASE COLORS

001 Black - 002 White - 007 Dark Blue - 011 Medium Blue - 018 Bright Red - 020 Red - 023 Tan - 031 Maroon  
 033 Dark Gold - 037 Aqua - 050 Turquoise - 051 Lime Green - 054 Purple - 057 Dk Olive Green  
 074 Pink - 079 Gray - 098 Brown - 129 Dark Saddle - 132 Gold

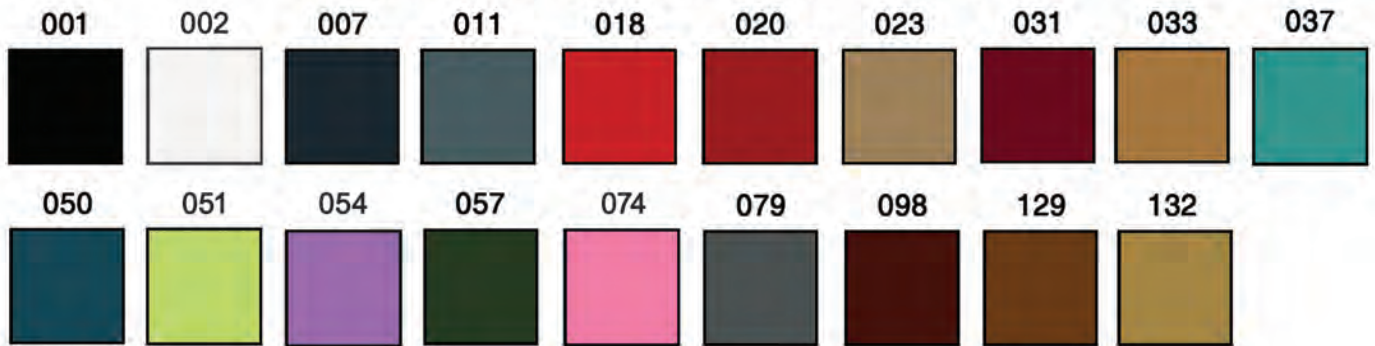

## INSERT COLORS

133 Cream - 134 Sandalwood - 137 Aztec Gold - 138 Buckskin - 139 Sienna - 141 Coffee Bean - 142 Football  
 143 Basketball - 150 Lemon Twist - 151 Mellow Yellow - 154 Plum Crazy - 156 Sky Blue - 157 Light Blue  
 159 Pacific Blue - 160 Caribbean Blue - 161 Royal Blue - 163 Navy Blue - 165 Sassy Grass - 166 Pine  
 167 Mint Green - 168 Hunter Green - 169 Antique Green - 170 Aqua Marine - 171 Mango - 173 Sunset Orange  
 174 Panther Pink - 176 Cherry Red - 177 Cranberry - 178 Razzberry - 179 Garnet - 180 Smoke  
 181 Platinum - 182 Medium Grey - 183 Silver - 184 Charcoal

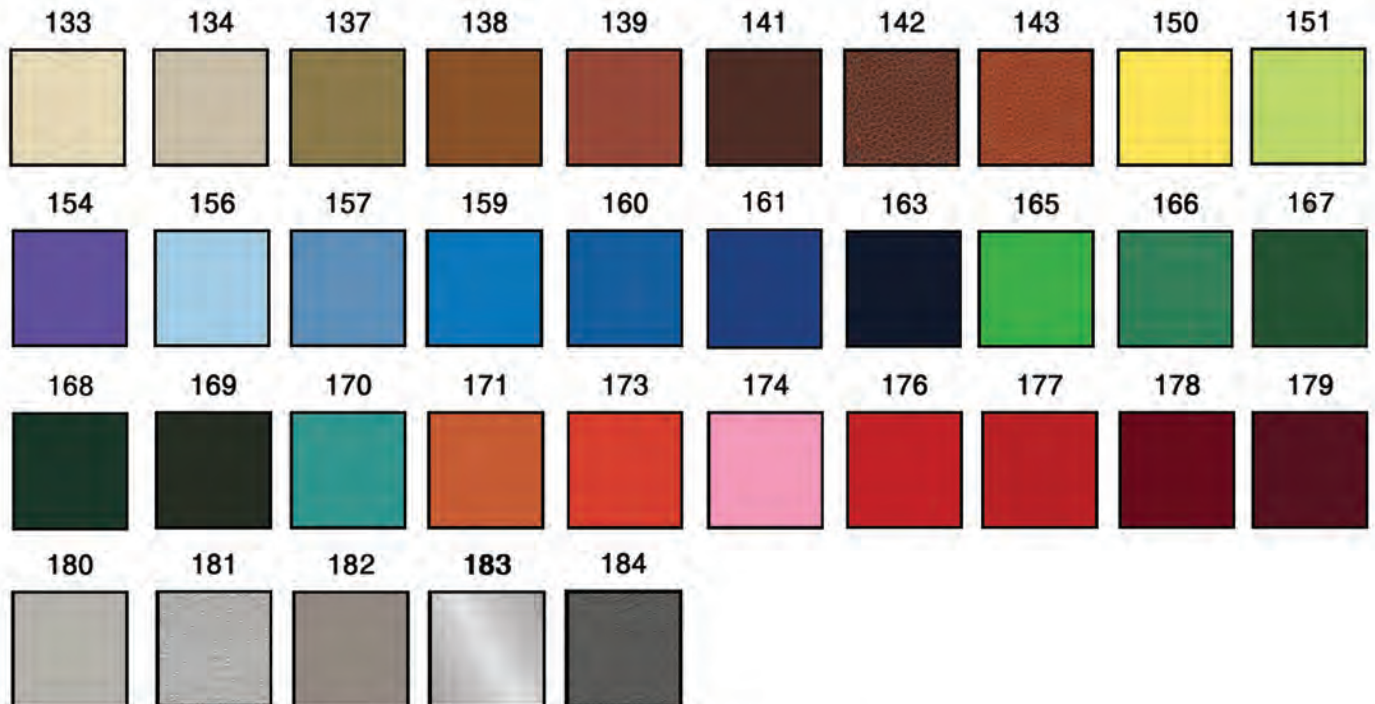

**\*Note - To order mats with colored inserts please call our sales department**

Actual colors will vary from samples on this page. Contact our Sample Request Department for actual color samples at 1-800-363-8804 or send us an email through our Sample Request Center on our website at [www.legendaryautointeriors.com](http://www.legendaryautointeriors.com)



# 1964-72 BUICK SKYLARK & GRAN SPORT

**SURE-GRIP™**  
CONTOUR ANTI-SLIP BACKING



[www.legendariautointeriors.com](http://www.legendariautointeriors.com)

**ALL NEW  
DESIGN!!**

**FLOORMAT PRICING:  
ALL COLORS - \$229.00/set**

**1964-65 Special**  
FMSK0001003(C)

**1966-67 Special**  
FMSK0001004(C)

**1964-66 Skylark**  
FMSK0001005(C)

**1967 Skylark**  
FMSK0001006(C)

**1965 Gran Sport w/ Buick logo**  
FMGS0001002(C)

**1966 Gran Sport**  
FMGS0001003(C)

**1967 Gran Sport - GS 340**  
FMGS0001004(C)

**1967 Gran Sport - GS 400**  
FMGS0001005(C)

**1967 Gran Sport - GS by Buick**  
FMGS0001006(C)

**1968-69 Skylark Custom**  
FMSK0002001(C)

**1968-72 Skylark w/ Buick logo**  
FMSK0002003(C)

**1970-72 Skylark Custom**  
FMSK0002004(C)

**1970-72 Skylark 350**  
FMSK0002005(C)

**1968-69 Gran Sport - GS 400**  
FMGS0002001(C)

**1968-72 Gran Sport - GS by Buick**  
FMGS0002003(C)

**1968-69 Gran Sport - GS 350**  
FMGS0002004(C)

**1968-69 Gran Sport - GS California**  
FMGS0002005(C)

**1970-72 Gran Sport - GS 455**  
FMGS0002006(C)

**1970-72 Gran Sport - GS Stage 1**  
FMGS0002007(C)

**1970-72 GSX**  
FMGS0002008(C)

1964-65 Special



1966-67 Special



1964-66 Skylark

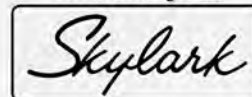

1967 Skylark



1965 Gran Sport



1966 Gran Sport



1967 GS 340



1967-69 GS 400



1967-72 GS by Buick



1968-69 Skylark Custom



1968-72 Skylark

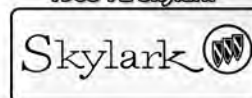

1970-72 Skylark Custom



1970-72 Skylark 350



1968-69 GS 350



1968-69 GS California



1970-72 GS 455



1970-72 GS Stage 1



1970-72 GSX



# ORIGINAL STYLE BUICK & CORVETTE

**SURE-GRIP™**  
CORVETTE ANTI-SKID BACKING



1964-72 Buick  
FMOR64GK(C)

**FLOORMAT PRICING:**  
**ALL COLORS - \$299.00/set**



**SURE-GRIP™**  
CORVETTE ANTI-SKID BACKING



1963-67 Corvette  
FMOR65GV(C)

**FLOORMAT PRICING:**  
**ALL COLORS - \$149.00/set**



# FLEX TREAD®

YOU ASK FOR IT...WE DELIVERED!!

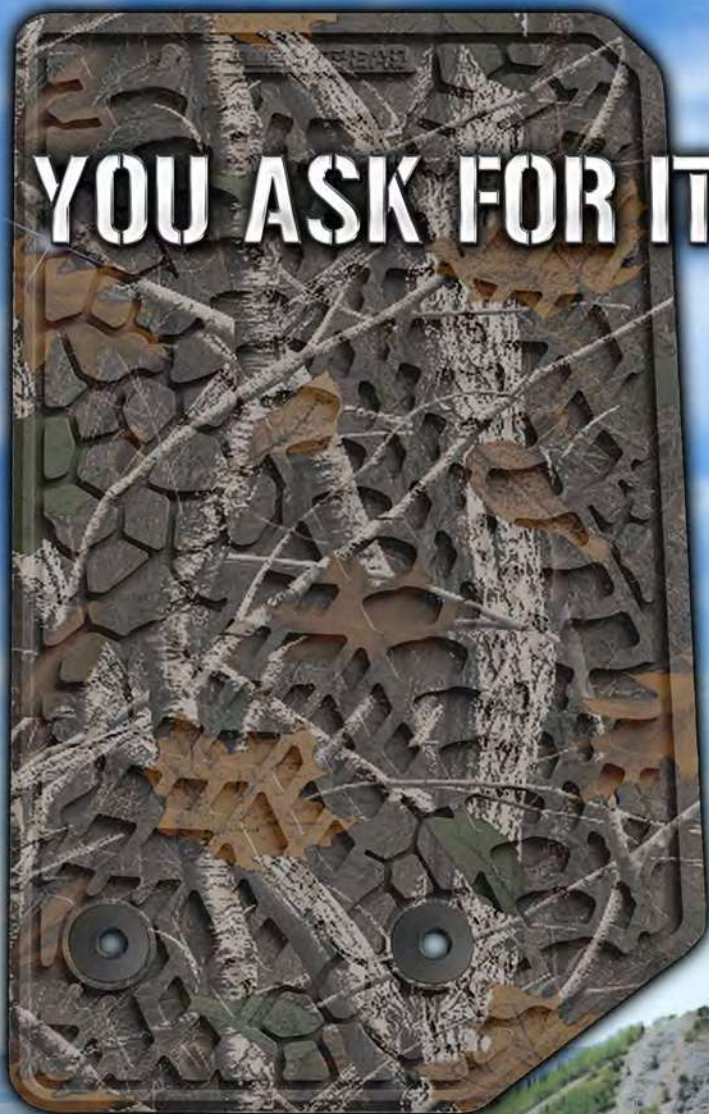

YOU ASK FOR IT...WE DELIVERED!!



\*\*\*

Flextread is providing the most innovative  
molded floormats in the industry

**RIGHT HERE AT HOME!**

All products are 100% assembled, designed  
and made in the U.S.A.

\*\*\*



\*\*\*

**THE NEXT GENERATION IN FLOORMATS™**

\*\*\*

**FLEXTREAD®**

# BOOTMAT COLORS



001 - Black



007 - Dark Blue



011 - Medium Blue



018 - Bright Red



020 - Red



051 - Lime Green



023 - Tan



031 - Maroon



050 - Turquoise



054 - Purple



057 - Dark Olive Green



074 - Pink



079 - Grey



098 - Brown



129 - Dark Saddle



132 - Gold

## CAMOUFLAGE

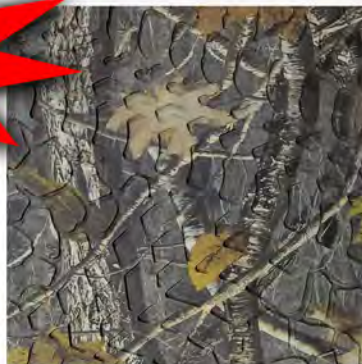

200 - Rugged Woods



202 - Cyberflage

**FLEXTREAD LLC**  
**1-833-700-3539**  
**WWW.FLEXTREADMATS.COM**



PATENTED

# SCENERY BOOT MATS

MANY KOOL SCENES  
AVAILABLE AND  
MORE COMING SOON!



DUCK SCENE



BEAR SCENE

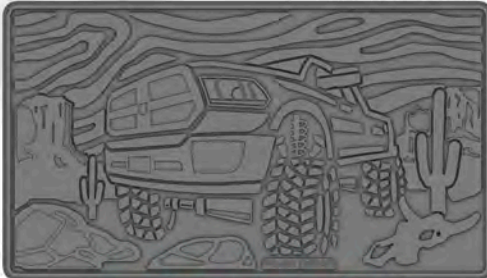

4X4 SCENE



TURKEY SCENE



FISHING SCENE



WHITETAIL SCENE



EQUINE SCENE

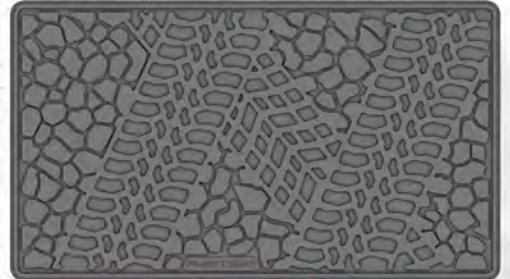

SCORCHED EARTH &  
TIRE TRACK SCENE



TREE SCENE

# FLEXTREAD®

1-833-700-3539 EXT. 222  
WWW.FLEXTREADMATS.COM



\*\*\*

Providing the automotive industry  
with the world's highest quality  
soft trim products and services  
RIGHT HERE AT HOME

\*\*\*

STILL ASSEMBLED AND  
MADE IN THE ★★★★★  
**USA** 

\*\*\*

THERE REALLY IS A DIFFERENCE!!

\*\*\*



*Legendary*  
**AUTO INTERIORS LTD.**



[www.legendaryautointeriors.com](http://www.legendaryautointeriors.com)





# DASHES, CONSOLES AND ACCESORIES

 [facebook.com/legendaryautointeriors](https://facebook.com/legendaryautointeriors)  
 [twitter.com/legendaryautoin](https://twitter.com/legendaryautoin)

 [www.legendaryautointeriors.com](http://www.legendaryautointeriors.com)  
 [instagram.com/legendaryautointeriorsltd](https://instagram.com/legendaryautointeriorsltd)  
 [youtube.com/user/legendaryauto](https://youtube.com/user/legendaryauto)

## PEDAL PADS & BEZELS

Reproduction pedal pads and bezels for accelerators, brake/clutch and parking brake.

### ACCELERATORS & BEZELS

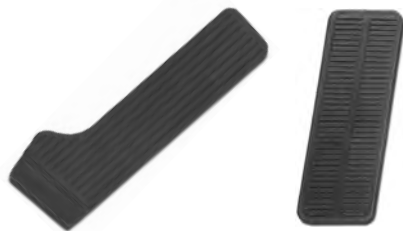

#### 1964-67 Skylark & Gran Sport

**PB64GA-A** (pad) (shown left) .....\$29.00/ea.  
 ☞ This pad is the closest available to the original.

#### 1968-72 Skylark & Gran Sport

**PB68GHK-A** (pad) (shown right).....\$ 8.00/ea.  
**PB68GHK-ABEZ** (bezel).....\$11.00/ea.

### 4-SPEED CLUTCH /BRAKE PADS & BEZELS



#### 1964-72 Skylark & Gran Sport

**PB64GA4SP-B/C** (pad).....\$6.00/ea.  
**PB64GA4SP-B/CBEZ** (bezel).....\$10.00/pr.

#### 1967-72 Skylark & Gran Sport (w/ Disc Brakes)

**PB67GA4SP-B/C** (pad).....\$17.00/ea.  
 ☞ Brake only. For clutch pad use part #PB64GA4SP-B/C.

### AUTOMATIC BRAKE PADS & BEZELS



#### 1964-72 Skylark & Gran Sport

**PB64GA-B** (pad).....\$15.00/ea.  
**PB64GG-BBEZ** (bezel).....\$19.00/ea.

#### 1967-72 Skylark & Gran Sport (w/ Disc Brakes)

**PB67GA-B** (pad).....\$15.00/ea.

## PEDAL PADS & BEZELS CONT.

### PARKING BRAKE PADS



#### 1964-72 Skylark & Gran Sport

**PB64GA-P** (pad).....\$ 6.00/ea.  
**PB64GA-PBEZ** (bezel).....\$ 6.00/ea.

### GAS PEDAL ROD PIN



Dimensionally accurate to the original with the same fit and function.

#### 1968-72 Skylark & Gran Sport NEW!!!

**PB68GA-RODPIN**..... \$7.00/ea.

### GAS PEDAL SPRING



Correct tension spring for all 68-72 A-Body applications.

#### 1968-72 Skylark & Gran Sport NEW!!!

**PB68GA-SPRING** ..... \$7.00/ea.

## 1970-72 WOODGRAIN DASH INSERTS

Make your dash look new again with these authentically reproduced woodgrain vinyl dash inserts for 1970-72 models with or without air conditioning.

#### 1970-72 Skylark & Gran Sport (all models)

**WC70GKW/O** (w/o A/C) .....\$61.00/ea.  
**WC70GKW/A** (with A/C) .....\$67.00/ea.

### WOODGRAIN CONSOLE INSERTS

Woodgrain console inserts are machine-stamped and feature an adhesive-backed design.

#### 1970-72 Skylark & Gran Sport

**WC70GK**.....\$43.00/ea.

### GLOVEBOX LINERS

Glovebox liners are die-cut and pre-stapled with all mounting hardware attached for easy installation.



#### 1964-65 Skylark & Gran Sport

**GB64GK**.....\$32.00/ea.

#### 1966-67 Skylark & Gran Sport

**GB66GK**.....\$32.00/ea.

#### 1968-69 Skylark & Gran Sport

**GB68GKW/O** (w/o A/C).....\$32.00/ea.  
**GB68GKW/A** (with A/C).....\$32.00/ea.

#### 1970-72 Skylark & Gran Sport

**GB70GKW/O** (w/o A/C).....\$43.00/ea.  
**GB70GKW/A** (with A/C).....\$43.00/ea.

## DASH PAD EMBLEMS

As-Original dash pad emblems

- 1966 Gran Sport**  
DP66GK-EMBLEM ..... \$29.00/ea
- 1966 Skylark (w/ long bird)**  
DP66GK-BIRDEMBLEM..... \$39.00/ea
- 1967 GS 400**  
DP67GK-EMBLEM ..... \$39.00/ea

## FIREWALL INSULATION



Die-cut jute insulation pad comes complete with a stamped rubber backing on one side like the originals. This insulation fastens to and runs the entire length of the firewall to help reduce engine heat and noise. Insulation clips included.

- 1964-67 Skylark & Gran Sport**  
FI64GA (without air conditioning).....\$65.00/ea.  
FI64GA-W/A (with air conditioning).....\$65.00/ea.
- 1968-72 Skylark & Gran Sport**  
FI68GA-W/O (w/o air conditioning) .....\$65.00/ea.  
FI68GA-W/A (with air conditioning).....\$65.00/ea.

## OEM FIREWALL INSULATION

Firewalls are cut and punched with standard factory holes and are shipped ready-to-install with the appropriate "period" insulation attached.

- 1964-67 Skylark & Gran Sport**   
FI64GAO (w/o air conditioning)..... \$298.00/ea.  
FI64GAO-W/A (with air conditioning) \$298.00/ea.
- 1968-72 Skylark & Gran Sport**   
FI68GAO (w/o air conditioning).....\$298.00/ea.  
FI68GAO-W/A (with air conditioning) \$298.00/ea.

## FIREWALL GUARD FASTENER

These fasteners will help keep your carpet guard and carpet in their proper positions.

- 1967-69 Camaro**  
FI-FASTENER (set of 4)..... \$17.00/set



## UNDERDASH INSULATION

Die-cut to original specifications, this insulation eliminates underdash noise and vibration.

- 1964-67 Skylark & Gran Sport**  
UD64GA ..... \$17.00/kit
- 1968-72 Skylark & Gran Sport**  
UD68GA ..... \$43.00/kit

## STEERING COLUMN SEAL

Precision die-cut gasket seals the steering column at the firewall.



- 1964-67 Skylark & Gran Sport**  
GK64GA (shown right)..... \$17.00/ea.
- 1968-72 Skylark & Gran Sport**  
GK68GA (shown left)..... \$17.00/ea.

## FIREWALL STEERING COLUMN COVER

Made of ABS plastic, this cover mounts where the steering column meets the firewall holding the carpet in place around the base of the steering column. Mounting hardware included.



- 1964-66 Skylark & Gran Sport**  
TA64GA-COVER (shown bottom).....\$59.00/ea.



- 1967 Skylark & Gran Sporto**  
TA67GA-COVER (shown bottom).....\$59.00/ea.



- 1968-72 Skylark & Gran Sport**  
TA68GA-COVER (shown top).....\$49.00/ea.

## SHIFTER BOOTS



This reproduction shifter boot fits 1965-67 models with standard transmission and no console.

- 1965-67 Skylark & Gran Sport**  
TN65GK-L (shown left) .....\$19.00/ea.





Reproduction shifter boots for 1965-72 models with a console and standard transmission. This boot fits on top of the console.



- 1965-72 Gran Sport**  
**1968-72 Skylark**  
TN65GK-U (shown right).....\$59.00/ea.





# HEADLINERS AND TRIM ACCESORIES

 [facebook.com/legendaryautointeriors](https://facebook.com/legendaryautointeriors)  
 [twitter.com/legendaryautoin](https://twitter.com/legendaryautoin)

 [www.legendaryautointeriors.com](http://www.legendaryautointeriors.com)  
 [instagram.com/legendaryautointeriorsltd](https://instagram.com/legendaryautointeriorsltd)  
 [youtube.com/user/legendaryauto](https://youtube.com/user/legendaryauto)

# Headliner Grains and Colors

Legendary Auto Interiors headliners are manufactured to original specifications and are available in a variety of colors in Perforated or Non-Perforated pattern. Each headliner is assembled with heavy-duty stitching.

If your year/model is not listed please contact our sales department for assistance on availability. Please specify perforated or non-perforated at time of order. Sample approval is highly recommended for colors other than black.

## STANDARD *style*

### Ribbed Bedford (1964 & 1968-69)

|                         |                     |                         |                        |                          |                         |                       |
|-------------------------|---------------------|-------------------------|------------------------|--------------------------|-------------------------|-----------------------|
| <b>01</b><br>Black      | <b>02</b><br>White  | <b>03</b><br>Red        | <b>07</b><br>Dark Blue | <b>11</b><br>Medium Blue | <b>13</b><br>Dark Green | <b>17</b><br>Buckskin |
| <b>18</b><br>Light Blue | <b>31</b><br>Maroon | <b>38</b><br>Sandalwood | <b>46</b><br>Ivy Gold  | <b>58</b><br>Powder Blue | <b>98</b><br>Brown      |                       |

### Tier (1965-67)

|                    |                         |                     |                        |                          |                          |                         |                       |
|--------------------|-------------------------|---------------------|------------------------|--------------------------|--------------------------|-------------------------|-----------------------|
| <b>01</b><br>Black | <b>02</b><br>White      | <b>03</b><br>Red    | <b>07</b><br>Dark Blue | <b>10</b><br>Bright Blue | <b>11</b><br>Medium Blue | <b>13</b><br>Dark Green | <b>17</b><br>Buckskin |
|                    | <b>20</b><br>Bright Red | <b>31</b><br>Maroon | <b>50</b><br>Turquoise | <b>58</b><br>Powder Blue | <b>79</b><br>Grey        | <b>98</b><br>Brown      |                       |

### Non-Perforated (1970-72)

|                    |                    |                  |                        |                          |                         |                         |                    |
|--------------------|--------------------|------------------|------------------------|--------------------------|-------------------------|-------------------------|--------------------|
| <b>01</b><br>Black | <b>02</b><br>White | <b>03</b><br>Red | <b>07</b><br>Dark Blue | <b>11</b><br>Medium Blue | <b>13</b><br>Dark Green | <b>38</b><br>Sandalwood | <b>98</b><br>Brown |
|--------------------|--------------------|------------------|------------------------|--------------------------|-------------------------|-------------------------|--------------------|

## HEADLINERS

### 1964 Skylark (Sport Coupe) (Ariel Grain)

HL64GK02A (white)..... \$169.00/ea.  
HL64GK58A (powder blue)..... \$169.00/ea.

### 1965 Skylark & Gran Sport (Coupe & Sport Coupe) (Tier Grain)

HL65GK02T (white)..... \$169.00/ea.  
HL65GK58T (powder blue)..... \$169.00/ea.

### 1966 Skylark & Gran Sport (Early production) (Coupe & Sport Coupe) (Tier Grain)

HL66GK01T1 (black)..... \$169.00/ea.  
HL66GK02T1 (white)..... \$169.00/ea.  
HL66GK03T1 (red)..... \$169.00/ea.  
HL66GK07T1 (dark blue)..... \$169.00/ea.  
HL66GK11T1 (medium Blue)..... \$169.00/ea.  
HL66GK50T1 (turquoise)..... \$169.00/ea.  
HL66GK79T1 (grey)..... \$169.00/ea.

☞ On early 1966 models the rear of the headliner continues to the package tray area and has a small sail panel. See diagram shown below.

### 1966 Skylark & Gran Sport (Late production) (Coupe & Sport Coupe) (Tier Grain)

HL66GK01T2 (black)..... \$169.00/ea.  
HL66GK02T2 (white)..... \$169.00/ea.  
HL66GK03T2 (red)..... \$169.00/ea.  
HL66GK07T2 (dark blue)..... \$169.00/ea.  
HL66GK11T2 (medium Blue)..... \$169.00/ea.  
HL66GK13T2 (dark Green)..... \$169.00/ea.  
HL66GK50T2 (turquoise)..... \$169.00/ea.  
HL66GK79T2 (grey)..... \$169.00/ea.

☞ Late 1966 models have a full sail panel board. See diagram shown below.

### 1967 Skylark & Gran Sport (Coupe & Sport Coupe) (Tier Grain)

HL67GK01T (black)..... \$169.00/ea.  
HL67GK02T (white)..... \$169.00/ea.  
HL67GK03T (red)..... \$169.00/ea.  
HL67GK07T (dark blue)..... \$169.00/ea.  
HL67GK11T (medium blue)..... \$169.00/ea.  
HL67GK50T (turquoise)..... \$169.00/ea.

### 1968 Skylark & Gran Sport (Sport Coupe) (Ribbed Bedford Grain)

HL68GK501R (black) (5-bow)..... \$169.00/ea.  
HL68GK502R (white) (5-bow)..... \$169.00/ea.  
HL68GK511R (med blue) (5-bow).... \$169.00/ea.  
HL68GK538R (sandalwood) (5-bow) \$169.00/ea.  
HL68GK601R (black) (6-bow)..... \$169.00/ea.  
HL68GK602R (white) (6-bow)..... \$169.00/ea.  
HL68GK611R (med blue) (6-bow).... \$169.00/ea.  
HL68GK638R (sandalwood) (6-bow) \$169.00/ea.

### 1969 Skylark & Gran Sport (Sport Coupe) (Ribbed Bedford Grain)

HL69GK01R (black)..... \$169.00/ea.  
HL69GK02R (white)..... \$169.00/ea.  
HL69GK11R (medium blue)..... \$169.00/ea.  
HL69GK13R (dark green)..... \$169.00/ea.  
HL69GK38R (sandalwood)..... \$169.00/ea.

### 1970-72 Skylark & Gran Sport (Coupe) (Non-Perforated Grain)

HL70GK01NP1 (black)..... \$169.00/ea.  
HL70GK11NP1 (medium blue)..... \$169.00/ea.  
HL70GK13NP1 (dark green)..... \$169.00/ea.  
HL70GK38NP1 (sandalwood)..... \$169.00/ea.  
HL70GK98NP1 (brown)..... \$169.00/ea.

### 1970-72 Skylark & Gran Sport (Sport Coupe) (Non-Perforated Grain)

HL70GK01NP2 (black)..... \$169.00/ea.  
HL70GK02NP2 (white)..... \$169.00/ea.  
HL70GK07NP2 (dark blue)..... \$169.00/ea.  
HL70GK11NP2 (medium blue)..... \$169.00/ea.  
HL70GK13NP2 (dark green)..... \$169.00/ea.  
HL70GK17NP2 (buckskin)..... \$169.00/ea.  
HL70GK38NP2 (sandalwood)..... \$169.00/ea.  
HL70GK98NP2 (brown)..... \$169.00/ea.

## NOS HEADLINERS

Some colors and grains are not reproduced in today's market. We offer NOS (New Old Stock) headliners for those extremely limited items. Many years and models are available. Please call for assistance.

HLNOS..... \$935.00/ea.  
☞ Please specify year and model.

## HEADLINER INSULATION

Headliner insulation kits glue directly to the roof and provide protection from noise, heat and cold infiltration.



**1964-67 Skylark & Gran Sport**  
HI64GA (4pc.).....\$29.00/ea.

**1968-72 Skylark & Gran Sport**  
HI68GA (4pc.).....\$29.00/ea.

## HEADLINER BOW RETAINER CLIPS

Plastic retainer clips slide onto the edge of the inner roof-rail and help secure the headliner bows during installation of headliner.



**1964-72 Skylark & Gran Sport**  
HLGA-CLIPS4 (Pkg/4).....\$21.00/pk.

**1968-72 Skylark & Gran Sport**  
HLGA-CLIPS6 (Pkg/6).....\$29.00/pk.

## UPPER WINDSHIELD TRIM

Interior upper windshield trim strip mounts at the top of the windshield and helps hold the headliner in place. Available in black only, paint as required.

**1964-67 Skylark & Gran Sport**  
WT64GA..... \$27.00/ea.

## REAR WINDOW TRIM

Interior rear window trim made of molded plastic features all the correct contours as the originals. This trim snaps into place around the rear window holding the headliner and sail panel boards in place along with providing a finished look. Available in black only, paint as required.

**1965 Skylark & Gran Sport (Hardtop)**  
RT65GK03 (Complete 3 pc. set)..... \$99.00/set

## SAIL PANEL BOARDS

Die-cut to original size and shape, these reproduction sail panel boards replace warped or water damaged originals. These panels are located between the package tray and headliner and come pre-covered with headliner material. Please specify pattern along with color at time of order.  
 NOTE: Due to a special proprietary process used in-house, we guarantee the vinyl WILL NOT bubble or delaminate from the board.



### 1964 Skylark & Gran Sport (Ariel Grain)

- SB64GK02A (white)..... \$97.00/pr.
- SB64GK58A (powder blue)..... \$97.00/pr.

### 1965 Skylark & Gran Sport (Tier Grain)

- SB64GK02T (white)..... \$66.00/pr.
- SB64GK58T (powder blue)..... \$66.00/pr.

### 1967 Skylark & Gran Sport (Tier Grain)

- SB66GK01T2 (black)..... \$66.00/pr.
- SB66GK02T2 (white)..... \$66.00/pr.
- SB66GK03T2 (red)..... \$66.00/pr.
- SB66GK07T2 (dark blue)..... \$66.00/pr.
- SB66GK11T2 (medium blue)..... \$66.00/pr.
- SB66GK50T2 (turquoise)..... \$66.00/pr.
- SB66GK79T2 (grey)..... \$66.00/pr.

### 1968-69 Skylark & Gran Sport (Ribbed Bedford Grain)

- SB68GK01R (black)..... \$66.00/pr.
- SB68GK02R (white)..... \$66.00/pr.
- SB68GK11R (medium blue)..... \$66.00/pr.
- SB68GK13R (dark green)..... \$66.00/pr.
- SB68GK38R (sandalwood)..... \$66.00/pr.

### 1970-72 Skylark & Gran Sport (Non-Perforated Grain)

- SB70GK01NP (black)..... \$66.00/pr.
- SB70GK02NP (white)..... \$66.00/pr.
- SB70GK07NP (dark blue)..... \$66.00/pr.
- SB70GK11NP (medium blue)..... \$66.00/pr.
- SB70GK13NP (dark green)..... \$66.00/pr.
- SB70GK17NP (buckskin)..... \$66.00/pr.
- SB70GK38NP (sandalwood)..... \$66.00/pr.
- SB70GK98NP (brown)..... \$66.00/pr.

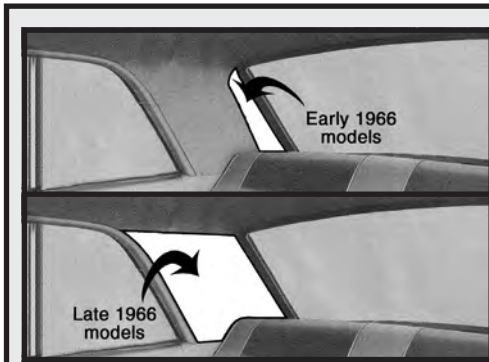

### 1966 Skylark & Gran Sport (Early production) (Tier Grain)

- SB66GK01T1 (black)..... \$55.00/pr.
- SB66GK02T1 (white)..... \$55.00/pr.
- SB66GK07T1 (dark blue)..... \$55.00/pr.
- SB66GK11T1 (medium blue)..... \$55.00/pr.
- SB66GK50T1 (turquoise)..... \$55.00/pr.
- SB66GK79T1 (grey)..... \$55.00/pr.

☞ Early 1966 models have a small sail panel.

### 1966 Skylark & Gran Sport (Late production) (Tier Grain)

- SB66GK01T2 (black)..... \$66.00/pr.
- SB66GK02T2 (white)..... \$66.00/pr.
- SB66GK03T2 (red)..... \$66.00/pr.
- SB66GK07T2 (dark blue)..... \$66.00/pr.
- SB66GK11T2 (medium blue)..... \$66.00/pr.
- SB66GK50T2 (turquoise)..... \$66.00/pr.
- SB66GK79T2 (grey)..... \$66.00/pr.

☞ Late 1966 models have a full sail panel board.

## DOME LIGHT LENS & BEZELS

Replacement dome light lenses and bezels for 1964-72 models.



### 1964-67 Skylark & Gran Sport

- LL64GA (Lens only)..... \$10.00/ea.
- LL64GA-BEZ (Bezel only)..... \$29.00/ea.



### 1968 Skylark & Gran Sport

- LL68GA (Lens only)..... \$15.00/ea.
- LL68GA-BEZ (Bezel only)..... \$29.00/ea.



### 1969-72 Skylark & Gran Sport

- LL69GA (Lens only)..... \$10.00/ea.
- LL69GA-BEZ (Bezel only)..... \$15.00/ea.

## COURTESY LIGHT LENSES & BEZELS

These replacement lenses and bezels mount to the interior sail panel boards located between the headliner and package tray.



### 1964-67 Skylark & Gran Sport

- LL64GA-CRTSY (Lens) (shown)..... \$10.00/ea.
- LL64GA-CRTSYBEZ (Bezel) (shown)..... \$49.00/ea.

## SAIL PANEL WITH COURTESY LIGHT

### 1964 Skylark & Gran Sport

- SB64GK(C)T-CRTSY..... \$57.00/ea.

### 1965 Skylark & Gran Sport

- SB65GK(C)T-CRTSY..... \$57.00/ea.

## PILLAR POST MOLDINGS

These urethane-molded, not foam filled pillar moldings feature authentic grain and texture as the originals. Available in Black only, but can be painted to match interior colors.



### 1968-69 Skylark & Gran Sport

- PP68GA-CPE01 (Black) (Coupe)..... \$129.00/pr.

### 1968-72 Skylark & Gran Sport

- PP68GA-CONV01 (Black) (Conv.)..... \$129.00/pr.



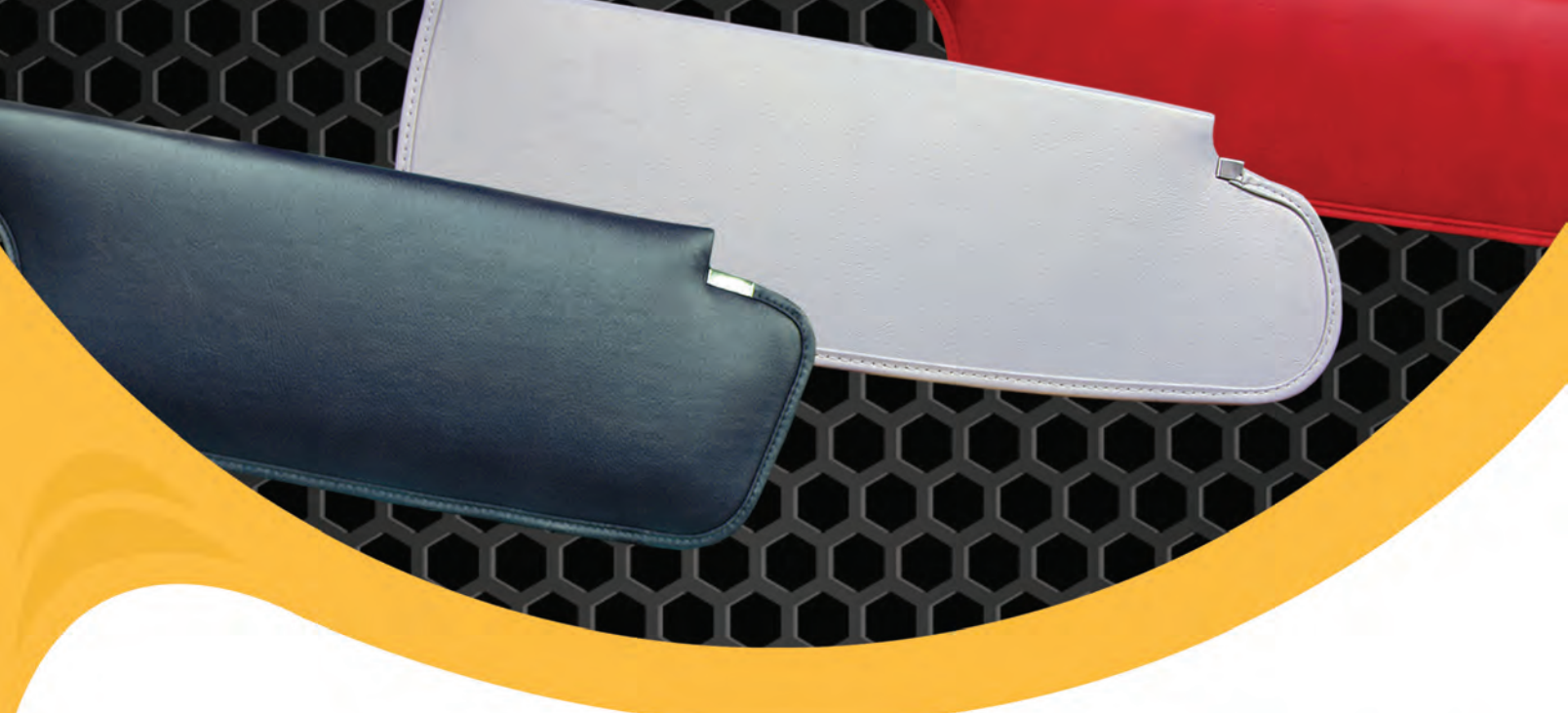

# SUNVISORS

Original reproduction sunvisors are made with the correct grains and vinyl colors as applicable by year/make/model to compliment and match your Legendary interior. Superior materials and technology with World Class craftsmanship create the highest quality sunvisors available. Original mounting hardware and metal rod must be reused. Please specify hardtop or convertible and color at time of order.

- Factory correct size, shape, colors and grains by year, make and model
- Original fit and appearance
- Custom colors and grains available
- Limited Lifetime Warranty (*First and only in the industry!!!*)
- Correct multi layer construction applicable by year, make and model
- Available with or without cut-outs for driver and passenger mirror options



***Correct multi layer construction & shape applicable by year, make, model & body style***

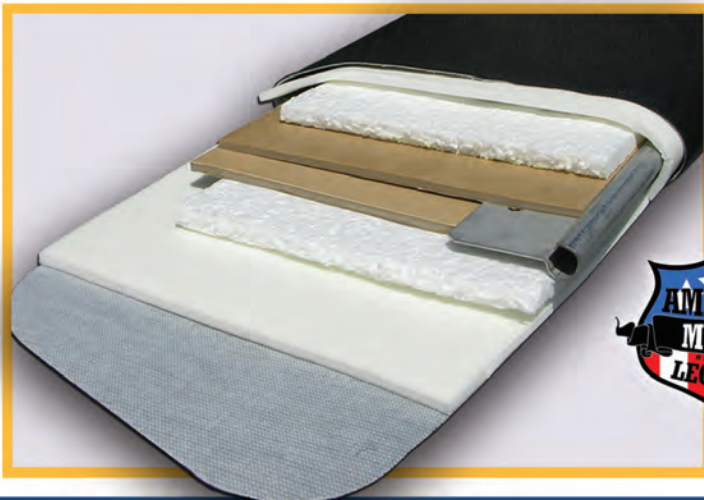

## HARDTOP & SPORTS COUPE SUNVISORS

**1964 Skylark & Gran Sport (Sport Coupe) (Ariel Grain)**  
 SV64GK02A-PA (white) ..... \$233.00/pr.  
 SV64GK58A-PA (powder blue) ..... \$233.00/pr.

**1965 Skylark & Gran Sport (Sport Coupe) (Tier Grain)**  
 SV65GK01T-PA (black) ..... \$168.00/pr.  
 SV65GK02T-PA (white) ..... \$168.00/pr.  
 SV65GK58T-PA (powder blue) ..... \$168.00/pr.

**1966-67 Skylark & Gran Sport (Sport Coupe) (Tier Grain)**  
 SV66GK01T-PA (black) ..... \$168.00/pr.  
 SV66GK02T-PA (white) ..... \$168.00/pr.  
 SV66GK07T-PA (dark blue) ..... \$168.00/pr.  
 SV66GK11T-PA (medium blue) ..... \$168.00/pr.  
 SV66GK50T-PA (turquoise) ..... \$168.00/pr.

**1968 Skylark & Gran Sport (Sport Coupe) (Ribbed Bedford Grain)**  
 SV68GK01R-PA (black) ..... \$168.00/pr.  
 SV68GK02R-PA (white) ..... \$168.00/pr.  
 SV68GK03R-PA (red) ..... \$168.00/pr.  
 SV68GK11R-PA (medium blue) ..... \$168.00/pr.  
 SV68GK13R-PA (dark green) ..... \$168.00/pr.  
 SV68GK17R-PA (buckskin) ..... \$168.00/pr.  
 SV68GK31R-PA (maroon) ..... \$168.00/pr.  
 SV68GK38R-PA (sandalwood) ..... \$168.00/pr.

**1969 Skylark & Gran Sport (Sport Coupe) (Ribbed Bedford Grain)**  
 SV69GK01R-PA (black) ..... \$168.00/pr.  
 SV69GK02R-PA (white) ..... \$168.00/pr.  
 SV69GK03R-PA (red) ..... \$168.00/pr.  
 SV69GK11R-PA (medium blue) ..... \$168.00/pr.  
 SV69GK13R-PA (dark green) ..... \$168.00/pr.  
 SV69GK17R-PA (buckskin) ..... \$168.00/pr.  
 SV69GK31R-PA (maroon) ..... \$168.00/pr.  
 SV69GK38R-PA (sandalwood) ..... \$168.00/pr.

**1970 Skylark & Gran Sport (Coupe & Sport Coupe) (Non-Perforated Grain)**  
 SV70GK01NP-PA (black) ..... \$168.00/pr.  
 SV70GK02NP-PA (white) ..... \$168.00/pr.  
 SV70GK03NP-PA (red) ..... \$168.00/pr.  
 SV70GK11NP-PA (medium blue) ..... \$168.00/pr.  
 SV70GK13NP-PA (dark green) ..... \$168.00/pr.  
 SV70GK17NP-PA (buckskin) ..... \$168.00/pr.  
 SV70GK31NP-PA (maroon) ..... \$168.00/pr.  
 SV70GK38NP-PA (sandalwood) ..... \$168.00/pr.

**1971-72 Skylark & Gran Sport (Coupe & Sport Coupe) (Non-Perforated Grain)**  
 SV71GK01NP-PA (black) ..... \$168.00/pr.  
 SV71GK02NP-PA (white) ..... \$168.00/pr.  
 SV71GK13NP-PA (dark green) ..... \$168.00/pr.  
 SV71GK17NP-PA (buckskin) ..... \$168.00/pr.  
 SV71GK38NP-PA (sandalwood) ..... \$168.00/pr.  
 SV71GK98NP-PA (brown) ..... \$168.00/pr.

## CONVERTIBLE SUNVISORS

**1964 Skylark - (Seville Grain)**  
 SV64GA100G-PA (black) ..... \$168.00/pr.  
 SV64GA220G-PA (frost white) ..... \$168.00/pr.  
 SV64GA325G-PA (metallic blue) ..... \$168.00/pr.  
 SV64GA508G-PA (red) ..... \$168.00/pr.  
 SV64GA656G-PA (brown) ..... \$176.00/pr. (L4)

**1965 Skylark & Gran Sport - (Madrid Grain)**  
 SV65GA100G-PA (black) ..... \$168.00/pr.  
 SV65GA220G-PA (frost white) ..... \$168.00/pr.  
 SV65GA325G-PA (light met blue) ..... \$168.00/pr.  
 SV65GA520G-PA (metallic red) ..... \$168.00/pr.  
 SV65GA679G-PA (saddle) ..... \$279.00/pr. (L1)

**1966-67 Skylark & Gran Sport - (Madrid Grain)**  
 SV66GA100G-PA (black) ..... \$168.00/pr.  
 SV66GA240G-PA (parchment) ..... \$176.00/pr. (L4)  
 SV66GA325G-PA (light met blue) ..... \$168.00/pr.  
 SV66GA343G-PA (dark met blue) ..... \$168.00/pr.  
 SV66GA420G-PA (metallic aqua) ..... \$168.00/pr.  
 SV66GA501G-PA (red) ..... \$168.00/pr.  
 SV66GA520G-PA (metallic red) ..... \$168.00/pr.  
 SV66GA640G-PA (pearl yellow) ..... \$168.00/pr.  
 SV66GA680G-PA (saddle) ..... \$168.00/pr.

**1968 Skylark & Gran Sport - (Madrid Grain)**  
 SV68GA100G-PA (black) ..... \$168.00/pr.  
 SV68GA135G-PA (platinum) ..... \$168.00/pr.  
 SV68GA220G-PA (frost white) ..... \$168.00/pr.  
 SV68GA333G-PA (blue) ..... \$176.00/pr. (L4)  
 SV68GA502G-PA (red) ..... \$176.00/pr. (L4)  
 SV68GA709G-PA (buckskin) ..... \$176.00/pr. (L4)

**1969 Skylark & Gran Sport - (Madrid Grain)**  
 SV69GA100G-PA (black) ..... \$168.00/pr.  
 SV69GA235G-PA (parchment) ..... \$168.00/pr.  
 SV69GA239G-PA (met parchment) ..... \$168.00/pr.  
 SV69GA325G-PA (light met blue) ..... \$168.00/pr.  
 SV69GA503G-PA (red) ..... \$176.00/pr. (L4)  
 SV69GA710G-PA (buckskin) ..... \$176.00/pr. (L4)

**1970-72 Skylark & Gran Sport - (Madrid Grain)**  
 SV70GA100G-PA (black) ..... \$168.00/pr.  
 SV70GA202G-PA (pearl white) ..... \$168.00/pr.  
 SV70GA230G-PA (white) ..... \$168.00/pr.  
 SV70GA465G-PA (72' green) ..... \$176.00/pr. (L4)  
 SV70GA468G-PA (71' green) ..... \$176.00/pr. (L4)  
 SV70GA658G-PA (burnt saddle) ..... \$168.00/pr.  
 SV70GA690G-PA (saddle) ..... \$168.00/pr.  
 SV70GA694G-PA (sandalwood) ..... \$168.00/pr.  
 SV70GA697G-PA (sandalwood) ..... \$176.00/pr. (L4)

## 1964-72 HARDTOP SUNVISOR SUPPORTS

Chrome sunvisor support with correct tension screw to insure an accurate fit for original and reproduction sunvisors.



**1964-72 Skylark & Gran Sport SV64GA-SUPPORT** ..... \$32.00/ea.

## SUNVISOR TIP & BUSHING KIT



Sunvisor tips with sleeves for 1964-72 models with double pin sunvisors and a center mounted sunvisor retainer over the rearview mirror. Set includes 2 rubber tips and 2 plastic sleeves.

**SVTIP-KIT** ..... \$10.00/kit

## CONVERTIBLE SUNVISOR BRACKETS



Diecast, high-strength, chromed to perfection. Guaranteed in fit and function to be identical to the original GM part.

**1964-65 Skylark & Gran Sport SV64GA-BRACKET** ..... \$139.00/pr.

**1966-67 Skylark & Gran Sport SV66GA-BRACKET** ..... \$99.00/pr.







**1968-72 Skylark & Gran Sport SV68GA-BRACKET** ..... \$99.00/pr.





# PACKAGE TRAY AND TRUNK ACCESORIES

 [facebook.com/legendaryautointeriors](https://facebook.com/legendaryautointeriors)  
 [twitter.com/legendaryautoin](https://twitter.com/legendaryautoin)

 [www.legendaryautointeriors.com](http://www.legendaryautointeriors.com)  
 [instagram.com/legendaryautointeriorsltd](https://instagram.com/legendaryautointeriorsltd)  
 [youtube.com/user/legendaryauto](https://youtube.com/user/legendaryauto)

# PACKAGE TRAYS AND JUTE INSULATION

Die-cut to original specifications, these reproductions of the original panels go between the top of the rear seat and the back window. Colors are year specific and are available with or without speaker grill cutouts. Die-cut jute insulation helps reduce the amount of noise and heat that would come from the trunk compartment.

## 1964-65 Skylark & Gran Sport (Coupe)

**(Without Cuts)**  
 PT64GKS100GN (black).....\$79.00/ea.  
 PT64GKS325GN (light metallic blue).....\$79.00/ea.  
 PT64GKS520GN (metallic red).....\$79.00/ea.  
 PT64GKS679GN (saddle).....\$79.00/ea.

**(With Cuts)**  
 PT64GKS100G (black).....\$119.00/ea.  
 PT64GKS325G (light metallic blue).....\$119.00/ea.  
 PT64GKS520G (metallic red).....\$119.00/ea.  
 PT64GKS679G (saddle).....\$119.00/ea.  
 PT64GKSJ (jute insulation).....\$25.00/ea.

Will fit both 2 & 4-door models.

## 1964 Skylark & Gran Sport (Sport Coupe)

**(Without Cuts)**  
 PT64GK100GN (black).....\$79.00/ea.  
 PT64GK334GN (dark metallic blue).....\$79.00/ea.  
 PT64GK405GN (metallic green).....\$79.00/ea.  
 PT64GK508GN (red).....\$79.00/ea.  
 PT64GK656GN (brown).....\$79.00/ea.

**(With Cuts)**  
 PT64GK100G (black).....\$119.00/ea.  
 PT64GK334G (dark metallic blue).....\$119.00/ea.  
 PT64GK405G (metallic green).....\$119.00/ea.  
 PT64GK508G (red).....\$119.00/ea.  
 PT64GK656G (brown).....\$119.00/ea.  
 PT64GKJ (jute insulation).....\$25.00/ea.

## 1965 Skylark & Gran Sport (Sport Coupe)

**(Without Cuts)**  
 PT64GK100GN (black).....\$79.00/ea.  
 PT64GK343GN (dark metallic blue).....\$79.00/ea.  
 PT64GK520GN (metallic red).....\$79.00/ea.  
 PT64GK679GN (saddle).....\$79.00/ea.

**(With Cuts)**  
 PT64GK100G (black).....\$119.00/ea.  
 PT64GK343G (dark metallic blue).....\$119.00/ea.  
 PT64GK520G (metallic red).....\$119.00/ea.  
 PT64GK679G (saddle).....\$119.00/ea.  
 PT64GKJ (jute insulation).....\$25.00/ea.

## 1966 Skylark & Gran Sport (Sport Coupe)

**(Without Cuts)**  
 PT66GK100GN (black).....\$79.00/ea.  
 PT66GK325GN (light metallic blue).....\$79.00/ea.  
 PT66GK420GN (light aqua).....\$79.00/ea.  
 PT66GK520GN (metallic red).....\$79.00/ea.

**(With Cuts)**  
 PT66GK100G (black).....\$119.00/ea.  
 PT66GK325G (light metallic blue).....\$119.00/ea.  
 PT66GK420G (light aqua).....\$119.00/ea.  
 PT66GK520G (metallic red).....\$119.00/ea.  
 PT66GKJ (jute insulation).....\$25.00/ea.

## 1967 Skylark & Gran Sport (Sport Coupe)

**(Without Cuts)**  
 PT66GK100GN (black).....\$79.00/ea.  
 PT66GK325GN (light metallic blue).....\$79.00/ea.  
 PT66GK343GN (dark metallic blue).....\$79.00/ea.  
 PT66GK448GN (turquoise).....\$79.00/ea.  
 PT66GK501GN (red).....\$79.00/ea.

**(With Cuts)**  
 PT66GK100G (black).....\$119.00/ea.  
 PT66GK325G (light metallic blue).....\$119.00/ea.  
 PT66GK343G (dark metallic blue).....\$119.00/ea.  
 PT66GK448G (turquoise).....\$119.00/ea.  
 PT66GK501G (red).....\$119.00/ea.  
 PT66GK650G (gold).....\$119.00/ea.  
 PT66GK680G (saddle).....\$119.00/ea.

**(With Cuts)**  
 PT66GK100G (black).....\$119.00/ea.  
 PT66GK325G (light metallic blue).....\$119.00/ea.  
 PT66GK343G (dark metallic blue).....\$119.00/ea.  
 PT66GK448G (turquoise).....\$119.00/ea.  
 PT66GK501G (red).....\$119.00/ea.  
 PT66GK650G (gold).....\$119.00/ea.  
 PT66GK680G (saddle).....\$119.00/ea.  
 PT66GKJ (jute insulation).....\$25.00/ea.

PACKAGE TRAYS & JUTE INSULATION

1968-72 Skylark (Sport Coupe) 

- (Without Cuts)  
 PT68GK100GN (black) ..... \$79.00/ea.  
 PT68GK135GN (platinum) ..... \$79.00/ea.  
 PT68GK333GN (blue) ..... \$79.00/ea.  
 PT68GK709GN (buckskin) ..... \$79.00/ea.  
 (With Cuts)  
 PT68GK100G (black) ..... \$119.00/ea.  
 PT68GK135G (platinum) ..... \$119.00/ea.  
 PT68GK333G (blue) ..... \$119.00/ea.  
 PT68GK709G (buckskin) ..... \$119.00/ea.  
 PT68GKJ (jute insulation) ..... \$25.00/ea.

1969 Skylark (Sport Coupe)

- (Without Cuts)  
 PT68GK100GN (black) ..... \$79.00/ea.  
 PT68GK325GN (metallic blue) ..... \$79.00/ea.  
 PT68GK450GN (metallic green) ..... \$79.00/ea.  
 PT68GK710GN (buckskin) ..... \$79.00/ea.  
 (With Cuts)  
 PT68GK100G (black) ..... \$119.00/ea.  
 PT68GK325G (metallic blue) ..... \$119.00/ea.  
 PT68GK450G (metallic green) ..... \$119.00/ea.  
 PT68GK710G (buckskin) ..... \$119.00/ea.  
 PT68GKJ (jute insulation) ..... \$25.00/ea.

1970 Skylark (Sport Coupe) 

- (Without Cuts)  
 PT68GK100GN (black) ..... \$79.00/ea.  
 PT68GK310GN (metallic blue) ..... \$79.00/ea.  
 PT68GK342GN (dark metallic blue) ..... \$79.00/ea.  
 PT68GK460GN (metallic green) ..... \$79.00/ea.  
 PT68GK658GN (burnished saddle) ..... \$79.00/ea.  
 PT68GK683GN (saddle) ..... \$79.00/ea.  
 PT68GK694GN (sandalwood) ..... \$79.00/ea.  
 (With Cuts)  
 PT68GK100G (black) ..... \$119.00/ea.  
 PT68GK310G (metallic blue) ..... \$119.00/ea.  
 PT68GK342G (dark metallic blue) ..... \$119.00/ea.  
 PT68GK460G (metallic green) ..... \$119.00/ea.  
 PT68GK658G (burnished saddle) ..... \$119.00/ea.  
 PT68GK683G (saddle) ..... \$119.00/ea.  
 PT68GK694G (sandalwood) ..... \$119.00/ea.  
 PT68GKJ (jute insulation) ..... \$25.00/ea.

1971 Skylark (Sport Coupe) 

- (Without Cuts)  
 PT68GK100GN (black) ..... \$79.00/ea.  
 PT68GK465GN (green) ..... \$79.00/ea.  
 PT68GK690GN (saddle) ..... \$79.00/ea.  
 PT68GK697GN (sandalwood) ..... \$79.00/ea.  
 (With Cuts)  
 PT68GK100G (black) ..... \$119.00/ea.  
 PT68GK465G (green) ..... \$119.00/ea.  
 PT68GK690G (saddle) ..... \$119.00/ea.  
 PT68GK697G (sandalwood) ..... \$119.00/ea.  
 PT68GKJ (jute insulation) ..... \$25.00/ea.

1972 Skylark (Sport Coupe) 

- (Without Cuts)  
 PT68GK100GN (black) ..... \$79.00/ea.  
 PT68GK465GN (green) ..... \$79.00/ea.  
 PT68GK690GN (saddle) ..... \$79.00/ea.  
 PT68GK697GN (sandalwood) ..... \$79.00/ea.  
 (With Cuts)  
 PT68GK100G (black) ..... \$119.00/ea.  
 PT68GK465G (green) ..... \$119.00/ea.  
 PT68GK690G (saddle) ..... \$119.00/ea.  
 PT68GK697G (sandalwood) ..... \$119.00/ea.  
 PT68GKJ (jute insulation) ..... \$25.00/ea.

1968 Gran Sport (Sport Coupe) 

- (Without Cuts)  
 PT68GKGS100GN (black) ..... \$79.00/ea.  
 PT68GKGS135GN (platinum) ..... \$79.00/ea.  
 PT68GKGS333GN (blue) ..... \$79.00/ea.  
 PT68GKGS709GN (buckskin) ..... \$79.00/ea.  
 (With Cuts)  
 PT68GKGS100G (black) ..... \$119.00/ea.  
 PT68GKGS135G (platinum) ..... \$119.00/ea.  
 PT68GKGS333G (blue) ..... \$119.00/ea.  
 PT68GKGS709G (buckskin) ..... \$119.00/ea.  
 PT68GKGSJ (jute insulation) ..... \$25.00/ea.

1969 Gran Sport (Sport Coupe) 

- (Without Cuts)  
 PT68GKGS100GN (black) ..... \$79.00/ea.  
 PT68GKGS325GN (metallic blue) ..... \$79.00/ea.  
 PT68GKGS450GN (metallic green) ..... \$79.00/ea.  
 PT68GKGS710GN (buckskin) ..... \$79.00/ea.  
 (With Cuts)  
 PT68GKGS100G (black) ..... \$119.00/ea.  
 PT68GKGS325G (metallic blue) ..... \$119.00/ea.  
 PT68GKGS450G (metallic green) ..... \$119.00/ea.  
 PT68GKGS710G (buckskin) ..... \$119.00/ea.  
 PT68GKGSJ (jute insulation) ..... \$25.00/ea.

1970 Gran Sport (Sport Coupe) 

- (Without Cuts)  
 PT68GKGS100GN (black) ..... \$79.00/ea.  
 PT68GKGS310GN (metallic blue) ..... \$79.00/ea.  
 PT68GKGS342GN (dark met blue) ..... \$79.00/ea.  
 PT68GKGS460GN (metallic green) ..... \$79.00/ea.  
 PT68GKGS658GN (burnished saddle) ..... \$79.00/ea.  
 PT68GKGS683GN (saddle) ..... \$79.00/ea.  
 PT68GKGS694GN (sandalwood) ..... \$79.00/ea.  
 (With Cuts)  
 PT68GKGS100G (black) ..... \$119.00/ea.  
 PT68GKGS310G (metallic blue) ..... \$119.00/ea.  
 PT68GKGS342G (dark met blue) ..... \$119.00/ea.  
 PT68GKGS460G (metallic green) ..... \$119.00/ea.  
 PT68GKGS658G (burnished saddle) ..... \$119.00/ea.  
 PT68GKGS683G (saddle) ..... \$119.00/ea.  
 PT68GKGS694G (sandalwood) ..... \$119.00/ea.  
 PT68GKGSJ (jute insulation) ..... \$25.00/ea.

1971 Gran Sport (Sport Coupe) 

- (Without Cuts)  
 PT68GKGS100GN (black) ..... \$79.00/ea.  
 PT68GKGS468GN (green) ..... \$79.00/ea.  
 PT68GKGS690GN (saddle) ..... \$79.00/ea.  
 PT68GKGS697GN (sandalwood) ..... \$79.00/ea.  
 (With Cuts)  
 PT68GKGS100G (black) ..... \$119.00/ea.  
 PT68GKGS468G (green) ..... \$119.00/ea.  
 PT68GKGS690G (saddle) ..... \$119.00/ea.  
 PT68GKGS697G (sandalwood) ..... \$119.00/ea.  
 PT68GKGSJ (jute insulation) ..... \$25.00/ea.

1972 Gran Sport (Sport Coupe) 

- (Without Cuts)  
 PT68GKGS100GN (black) ..... \$79.00/ea.  
 PT68GKGS465GN (green) ..... \$79.00/ea.  
 PT68GKGS690GN (saddle) ..... \$79.00/ea.  
 (With Cuts)  
 PT68GKGS100G (black) ..... \$119.00/ea.  
 PT68GKGS465G (green) ..... \$119.00/ea.  
 PT68GKGS690G (saddle) ..... \$119.00/ea.  
 PT68GKGSJ (jute insulation) ..... \$25.00/ea.

TRUNK DIVIDERS & JUTE INSULATION

Die-cut reproductions of the black fiberboard panel that separates the trunk compartment from the passenger area. Trunk divider jute padding is recommended to provide insulation from moisture and reduces the amount of heat and noise from the trunk compartment.



1964-67 Skylark & Gran Sport 

- TD64GK (Coupe models) ..... \$37.00/ea.  
 TD64GKJ (jute insulation) ..... \$27.00/ea.

1968-72 Skylark & Gran Sport 

- TD68GK (Coupe models) ..... \$37.00/ea.  
 TD68GKJ (jute insulation) ..... \$27.00/ea.



# TRUNK MATS

Original style rubber trunk mats die-cut to factory specifications to assure a correct fit. Please specify material pattern at time of order.

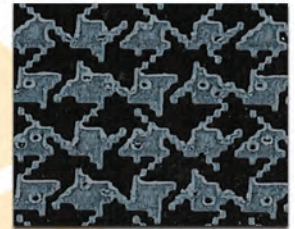

Houndstooth

## TRUNK MATS

Original style rubber trunk mats feature correct backings and are die-cut from factory specifications to assure a correct fit. Available in original patterns and colors.

### 1964-65 Skylark & Gran Sport

**TM64GK-GHT** (Gray Houndstooth).....\$99.00/ea.  
**TM64GK-AHT** (Aqua Houndstooth).....\$99.00/ea.

### 1966-67 Skylark & Gran Sport

**TM66GK-GHT** (Gray Houndstooth).....\$99.00/ea.  
**TM66GK-AHT** (Aqua Houndstooth).....\$99.00/ea.

### 1968-72 Skylark & Gran Sport

**TM68GK-GHT** (Gray Houndstooth).....\$99.00/ea.  
**TM68GK-AHT** (Aqua Houndstooth).....\$99.00/ea.

## SPARE TIRE COVER

Add the finishing touch to your trunk with a spare tire cover to match your trunk mat. Made from the same trunk mat material, these covers will fit any vehicle with a floor mounted spare tire. Please specify material pattern at time of order.

### 1964-72 Skylark & Gran Sport

**ST64GK-14GHT** (14" Gray Houndstooth) ...\$65.00/ea.  
**ST64GK-15GHT** (15" Gray Houndstooth) ...\$65.00/ea.  
**ST64GK-14AHT** (14" Aqua Houndstooth) ...\$65.00/ea.  
**ST64GK-15AHT** (15" Aqua Houndstooth) ...\$65.00/ea.

## SPARE TIRE BOARD

Die-cut reproduction lid for your spare tire. These lids are made with the same patterns as the trunk mats and were used when the spare tire cover was not ordered.

### 1964-72 Skylark & Gran Sport

**ST64GK-BLK** (Black).....\$32.00/ea.  
**ST64GK-AHT** (Aqua Houndstooth).....\$43.00/ea.

### 1968-72 Skylark & Gran Sport

**ST68GK-SP** (Speckled).....\$54.00/ea.

## TRUNK MAT MATERIAL

Legendary Auto Interiors offers an uncut roll of trunk mat material in Houndstooth, Green/Gray or Herringbone for models not offered. You cut to size this 52" x 80" roll.



**TMROLLHT** (Gray Houndstooth) .....\$59.00/ea.  
**TMROLLAHT** (Aqua Houndstooth).....\$89.00/ea.

## 1964-72 TRUNK AREA SPEAKER COVER

Die-cut using laminated fiberboard just like the originals, these speaker covers are lined with jute insulator for an exact reproduction.



### 1964-65 Skylark & Gran Sport

**SC64GA** (Coupe models).....\$32.00/ea.

### 1966-72 Skylark & Gran Sport

**SC66GA** (Coupe models).....\$38.00/ea.



# VINYL TOPS CONVERTIBLE TOPS AND ACCESORIES

 [facebook.com/legendaryautointeriors](https://facebook.com/legendaryautointeriors)

 [twitter.com/legendaryautoin](https://twitter.com/legendaryautoin)

 [www.legendaryautointeriors.com](http://www.legendaryautointeriors.com)

 [instagram.com/legendaryautointeriorsltd](https://instagram.com/legendaryautointeriorsltd)

 [youtube.com/user/legendaryauto](https://youtube.com/user/legendaryauto)



# VINYL TOPS

Legendary Auto Interiors, Ltd. "fitted" vinyl tops are manufactured to original specifications with the correct 100% cotton drill backing that gives trouble free installation and long term durability. All seams are double stitched and die-electrically heat-sealed insuring accurate deck width and seam durability. Each top is individually cut and fit for each specific year, make and model to give that perfect Legendary fit. Every Legendary vinyl top carries a (5) year factory warranty, the best in the industry!!

## VINYL TOPS

### 1964-65 Skylark & Gran Sport

VTL28GA01S (satin black)..... \$399.00/ea.

VTL28GA02S (satin white)..... \$399.00/ea.

### 1966-67 Skylark & Gran Sport

VTL29GA01S (satin black)..... \$399.00/ea.

VTL29GA02S (satin white)..... \$399.00/ea.

### 1968-69 Skylark & Gran Sport

VTL30GHK01S (satin black)..... \$399.00/ea.

VTL30GHK02S (satin white)..... \$399.00/ea.

### 1970-71 Skylark & Gran Sport

VTL31GHK01S (satin black)..... \$399.00/ea.

VTL31GHK02S (satin white)..... \$399.00/ea.

### 1972 Skylark & Gran Sport

VTL31GHK01G (gloss black)..... \$399.00/ea.

VTL31GHK02G (gloss white)..... \$399.00/ea.

### 1972 Skylark Custom

VTL32GK01G (gloss black) ..... \$399.00/ea.

VTL32GK02G (gloss white) ..... \$399.00/ea.

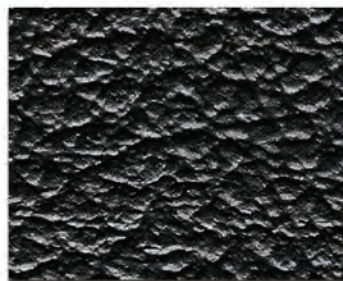

Levant Grain  
(Black)

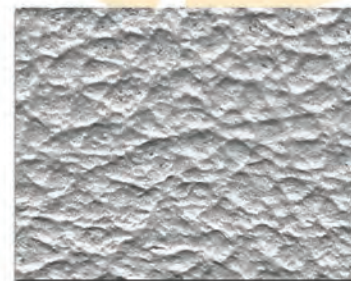

Levant Grain  
(White)

## NOS VINYL TOPS

Oldsmobile offered a variety of vinyl top colors other than black and white for F-85, Cutlass & 442 models. Colors such as blue, teal, green, gold and buckskin have not yet been reproduced. In our efforts to better serve you in your restoration needs, Legendary is continuously searching for NOS (New Old Stock) vinyl top material. Please call for more information.

**VTNOS** .....\$1129.00/ea.

Please specify year/make/model and color at time of order.

# Convertible Top Color Samples

## K.V. "Pinpoint Grain"

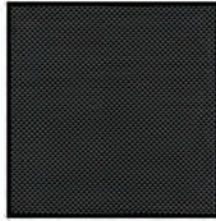

**01 Black**

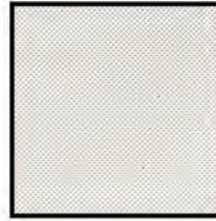

**02 White**

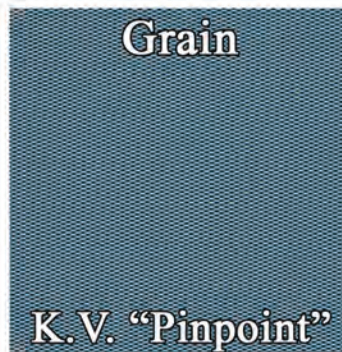

### CONVERTIBLE TOPS



1971 Buick Skylark Custom

#### 1964-65 Skylark & Gran Sport

CT64GA(C)T (Black and White only) ..... \$399.00/ea.  
 CT64GA-P (Plastic curtain only) ..... \$229.00/ea.

#### 1968-72 Skylark & Gran Sport 052

CT68GAC)T (Black and White only) ..... \$399.00/ea.  
 CG68GA(C) (Glass curtain only) ..... \$399.00/ea.

#### 1966-67 Skylark & Gran Sport

CT66GA(C)T (Black and White only) ..... \$399.00/ea.  
 CT66GA-P (Plastic curtain only) ..... \$229.00/ea.

# CONVERTIBLE TOPS AND ACCESSORIES



Legendary Auto Interiors, Ltd. convertible tops are reproduced to factory original specifications using correct heavyweight 36oz. material. Convertible tops are available in the original KV "Pinpoint" grain on all 1964-72 Skylark & GS models. Rear window curtains are available in glass or plastic depending on year and model. We also have convertible tops available for many other models. For colors other than black and white and models not listed, please call for assistance. As with all Legendary Auto Interiors, Ltd. products, these reproduction convertible tops are the finest available and come with a (2) year manufacturer's warranty (glass curtains come with a (1) year warranty) against defects in materials and workmanship.

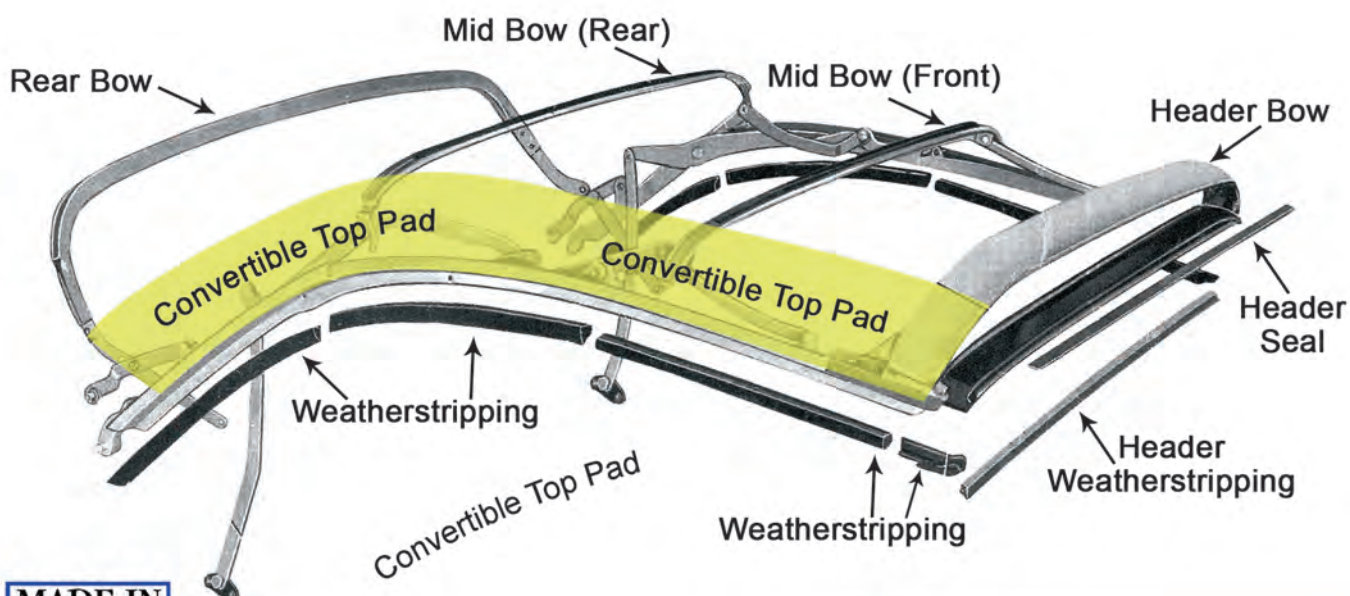

# Skylark/Gran Sport CONVERTIBLE TOP TENSION CABLES

These tension cables install into the cable sleeves that are sewn into the convertible top keeping it secure to the top frame.



1964-65 Skylark & Gran Sport  
CT64GA-CABLE..... \$69.00/pr.

1966-67 Skylark & Gran Sport  
CT66GA-CABLE..... \$69.00/pr.

1968-72 Skylark & Gran Sport  
CT68GA-CABLE..... \$49.00/pr.

## 1964-65 & 1968-72 CONVERTIBLE TOP GUIDE PIN

These chrome plated pins screw into the top frame and slide into the header panel aligning the convertible top with the front windshield.



1964-65 Skylark & Gran Sport  
1968-72 Skylark & Gran Sport  
CT64GA-GUIDE..... \$10.00/ea.

## 1964-72 CONVERTIBLE TOP LATCH HOOK KNUCKLES

Case-hardened steel reproductions are identical to the originals. These latch knuckles pivot at the front end of the latch assembly where the latch hooks (CT64GA-HOOK) thread into place. Complete with rolled press-on attaching pin.



1964-72 Skylark & Gran Sport  
CT64GA-KNUCKLE..... \$54.00/pr.

## 1966-67 CONVERTIBLE TOP PLASTIC GUIDE PINS

These reproduction plastic guide pins, also known as anti-rattle plates, help align the convertible top when latched into place with the windshield header panel.



1966-67 Skylark & Gran Sport  
CT66GA-GUIDE..... \$39.00/pr.

## CONVERTIBLE TOP PADS

Universal convertible top pads fit between the top and metal frame rails, protecting the top from wear and damage. Highly recommended with installation of new convertible tops.



CTPAD74STD (1964-67)..... \$79.00/pr.  
CTPAD68GA (1968-72)..... \$52.00/pr.

## 1968-72 CONVERTIBLE HEADER PANEL VINYL

Pre-cut Madrid grain header vinyl wraps over the header bow that attaches to the front of the convertible top frame. Please specify year and color at time of order.

1968-72 Skylark & Gran Sport  
VV68GAHEADER(C)..... \$30.00-\$32.00/ea.

## 1964-72 CONVERTIBLE TOP LATCH HOOKS

Case-hardened steel reproduction hooks secure the top to the upper windshield framing. Chrome plated with pin-holed rubber punch mounting insert included.



1964-72 Skylark & Gran Sport  
CT64GA-HOOK..... \$11.00/ea.

## 1964-67 CONVERTIBLE TOP MOTOR COVER

Die-cut black laminated fiber board motor cover has been shape-formed to fit exactly like the original.



1964-67 Skylark & Gran Sport  
TP64GA..... \$11.00/ea.

## CONVERTIBLE BOOT DUST COVER

Protect your convertible boot with this convertible boot dust cover made in Levant grain with a satin finish. Comes in Black only



CB67MCBAG01..... \$39.00/ea.

## CONVERTIBLE BOOTS

Legendary Auto Interior's convertible boots feature protective foam pockets and are sewn to original factory specifications. We are the only manufacturer making "as original" convertible boots using authentic grain vinyls and correct metal snaps or clips by year and model. 1964 models use Seville grain vinyl and 1965-72 models use Madrid grain vinyl. Every Legendary convertible boot carries a (5) year factory warranty, the best in the industry!

### 1964 Skylark

#### CB64GA00017(C) (shown)

100G, 220G, 310G, 508G ..... \$359.00/ea.  
 656G ..... \$377.00/ea. (L4)  
 405G ..... \$709.00/ea. (L1)

☞ 405G Metallic Green uses special run material.

#### CB64GAP0017(C) \*(Plastic Clips)

100G, 220G, 310G, 508G ..... \$359.00/ea.  
 656G ..... \$377.00/ea. (L4)  
 405G ..... \$709.00/ea. (L1)

☞ Plastic Clips are custom and therefore non-returnable, non-refundable

#### 1964 (C) COLOR CODES

|                            |                       |
|----------------------------|-----------------------|
| (100G) Black               | (405G) Metallic Green |
| (220G) Frost White         |                       |
| (325G) Light Metallic Blue | (508G) Red            |
|                            | (656G) Brown          |

### 1965 Skylark & Gran Sport

#### CB65GA00017(C)

100G, 220G, 325G, 520G ..... \$359.00/ea.  
 679G ..... \$709.00/ea. (L1)

#### CB65GAP0017(C) \*(Plastic Clips)

100G, 220G, 325G, 520G ..... \$359.00/ea.  
 679G ..... \$709.00/ea. (L1)

☞ Plastic Clips are custom and therefore non-returnable, non-refundable

#### 1965 (C) COLOR CODES

|                            |                     |
|----------------------------|---------------------|
| (100G) Black               | (520G) Metallic Red |
| (220G) Frost White         | (679G) Saddle       |
| (325G) Light Metallic Blue |                     |

### 1966 Skylark & Gran Sport

#### CB66GA00017(C)

(All Colors) ..... \$349.00/ea.

#### 1966 (C) COLOR CODES

|                           |                            |
|---------------------------|----------------------------|
| (100G) Black              | (325G) Light Metallic Blue |
| (240G) Metallic Parchment | (520G) Metallic Red        |

### 1967 Skylark & Gran Sport

#### CB66GA00017(C)

100G, 240G, 343G, 501G, 640G ..... \$349.00/ea.  
 680G ..... \$709.00/ea. (L2)

☞ 240G Metallic Parchment requires sample approval.

☞ 680G Saddle uses New Old Stock (NOS) material.

#### 1967 (C) COLOR CODES

|                           |                     |
|---------------------------|---------------------|
| (100G) Black              | (501G) Red          |
| (240G) Metallic Parchment | (640G) Pearl Yellow |
| (343G) Dark Metallic Blue | (680G) NOS Saddle   |

### 1968 Skylark & Gran Sport

#### CB68GA00017(C)

100G, 220G ..... \$349.00/ea.  
 333G, 502G, 709G ..... \$366.00/ea. (L4)  
 135G ..... \$709.00/ea.

#### CB68GAE0017(C) (early 68 w/ clips)

100G, 220G ..... \$349.00/ea.  
 333G, 502G, 709G ..... \$366.00/ea. (L4)  
 135G ..... \$709.00/ea.

☞ 135G NOS Platinum requires sample approval.

#### 1968 (C) COLOR CODES

|                     |                 |
|---------------------|-----------------|
| (100G) Black        | (333G) Blue     |
| (135G) NOS Platinum | (502G) Red      |
| (220G) Frost White  | (709G) Buckskin |

### 1969 Skylark & Gran Sport

#### CB68GA00017(C)

100G, 235G, 239G, 325G ..... \$349.00/ea.  
 503G, 710G ..... \$366.00/ea. (L4)

#### 1969 (C) COLOR CODES

|                           |                      |
|---------------------------|----------------------|
| (100G) Black              | (325G) Metallic Blue |
| (235G) Parchment          | (503G) Red           |
| (239G) Metallic Parchment | (710G) Buckskin      |

### 1970 Skylark & Gran Sport

#### CB68GA00017(C)

(All Colors) ..... \$349.00/ea.

#### 1970 (C) COLOR CODES

|                    |                         |
|--------------------|-------------------------|
| (100G) Black       | (658G) Burnished Saddle |
| (202G) Pearl White | (694G) Sandalwood       |

### 1971 Skylark & Gran Sport

#### CB68GA00017(C)

100G, 202G, 690G ..... \$349.00/ea.  
 468G, 697G ..... \$366.00/ea. (L4)

#### 1971 (C) COLOR CODES

|                    |                   |
|--------------------|-------------------|
| (100G) Black       | (690G) Saddle     |
| (202G) Frost White | (697G) Sandalwood |
| (468G) Green       |                   |



1969 Buick Skylark Custom

## CONVERTIBLE WELL LINERS

These liners install behind the rear seat protecting your convertible top from wear and damage when placed in the down position. Legendary is the only manufacturer making factory exact well liners available today, backed by a (5) year factory warranty.

### 1964-65 Skylark & GS

WL64GA00016100G (black) ..... \$219.00/ea.

☞ No plastic strips or snaps. Staples to trim strip before convertible top is installed.

### 1966-67 Skylark & GS

WL66GA00016100G (black) ..... \$219.00/ea.

☞ Features a plastic attachment strip.

### 1968-72 Skylark & GS

WL68GA00016100G (black) ..... \$249.00/ea.

☞ Features a Rip-Stop plastic pocketed outer lining containing a thick layer of high loft felt.

☞ A LEGENDARY AUTO INTERIORS, LTD. EXCLUSIVE

## CONVERTIBLE BODY SCREW STUDS



5/8" Phillips head stainless steel body screw studs for snap down boot and well liner applications.

CBBOOTBEZSCRW (Pkg/35) ..... \$16.00/pk.

### 1972 Skylark & Gran Sport

#### CB68GA00017(C)

100G, 230G, 690G ..... \$349.00/ea.

465G ..... \$366.00/ea. (L4)



#### 1972 (C) COLOR CODES



|              |               |
|--------------|---------------|
| (100G) Black | (465G) Green  |
| (230G) White | (690G) Saddle |





# WEATHERSTRIPING AND ACCESORIES

 [facebook.com/legendaryautointeriors](https://facebook.com/legendaryautointeriors)  
 [twitter.com/legendaryautoin](https://twitter.com/legendaryautoin)

 [www.legendaryautointeriors.com](http://www.legendaryautointeriors.com)  
 [instagram.com/legendaryautointeriorsltd](https://instagram.com/legendaryautointeriorsltd)  
 [youtube.com/user/legendaryauto](https://youtube.com/user/legendaryauto)

## DOOR WEATHERSTRIPPING

Thick molded rubber weatherstrip includes the necessary clips and correct molded endpads for an excellent fit. These pieces wrap around the bottom and sides of each door.

### 1964-65 Skylark & Gran Sport

WS64GA-DOOR (Sport Cpe. & Conv.)...\$169.00/pr.  
WS64GA-DOORS (Coupe).....\$109.00/pr.

### 1966-67 Skylark & Gran Sport

WS66GA-DOOR (Sport Cpe. & Conv.)...\$159.00/pr.  
WS66GA-DOORS (Coupe).....\$99.00/pr.

### 1968 Skylark & Gran Sport

WS68GA-DOOR (Sport Cpe. & Conv.)...\$159.00/pr.

### 1968-72 Skylark & Gran Sport

WS68GA-DOORS (Coupe).....\$99.00/pr.

### 1969-72 Skylark & Gran Sport

WS69GA-DOOR (Sport Cpe. & Conv.)...\$199.00/pr.

## DOOR LOCK SEALS



These molded rubber "U" shaped seals screw onto the door jamb pillar to seal the front edge of the rear-down windows.

### 1964-65 Skylark & Gran Sport (Sport Coupe & Convertible)

WS64GA-DOORLK.....\$59.00/pr.

### 1966-67 Skylark & Gran Sport (Sport Coupe & Convertible)

WS66GA-DOORLK (shown).....\$59.00/pr.

### 1968-72 Skylark & Gran Sport (Sport Coupe & Convertible)

WS68GA-DOORLK.....\$79.00/pr.

## ROOF RAIL WEATHERSTRIPPING

Thick molded rubber with correct molded endpads. These start at the base of the windshield pillar post and follow along the outer edge of the roofline to the rear of the quarter window.



### 1964-65 Skylark & Gran Sport

WS64GA-ROOF (Sport Coupe).....\$129.00/pr.

### 1966-67 Skylark & Gran Sport

WS66GA-ROOF (Sport Coupe).....\$119.00/pr.

### 1968 Skylark & Gran Sport

WS68GA-ROOF (Sport Coupe).....\$129.00/pr.

### 1969-72 Skylark & Gran Sport (shown)

WS69GA-ROOF (Sport Coupe).....\$129.00/pr.

## HOOD-TO-COWL SEALS

This rubber piece seals the underside of the hood to the cowl. Installs on the front edge of the cowl area where the back edge of the hood meets.

### 1964-67 Skylark & Gran Sport

WS64GA-HOOD.....\$39.00/ea.

### 1968-72 Skylark & Gran Sport

WS68GA-HOOD.....\$29.00/ea.

## REAR QUARTER WINDOW SEALS

These seals have a steel core molded inside the rubber and install into the chrome track located on the front edge of the rear roll-up quarter window.



### 1964-65 Skylark & Gran Sport

WS64GA-QTRH (Sport Coupe).....\$49.00/pr.

### 1964-65 Skylark & Gran Sport

WS64GA-QTRC (Convertible).....\$49.00/pr.

### 1966-67 Skylark & Gran Sport

WS66GA-QTR (Sport Cpe. & Conv.).....\$49.00/pr.

### 1968-72 Skylark & Gran Sport (shown)

WS68GA-QTR (Sport Cpe. & Conv.).....\$59.00/pr.

## TRUNK SEALS

Trunk seal kits feature correct original profile extruded foam for hardtop, sports coupe and convertible models. These seal the trunk lid preventing water leaks. 16" in length.



### 1964-72 Skylark & Gran Sport

TS64GA.....\$29.00/ea.

### COUPE / SPORT COUPE WEATHERSTRIPPING

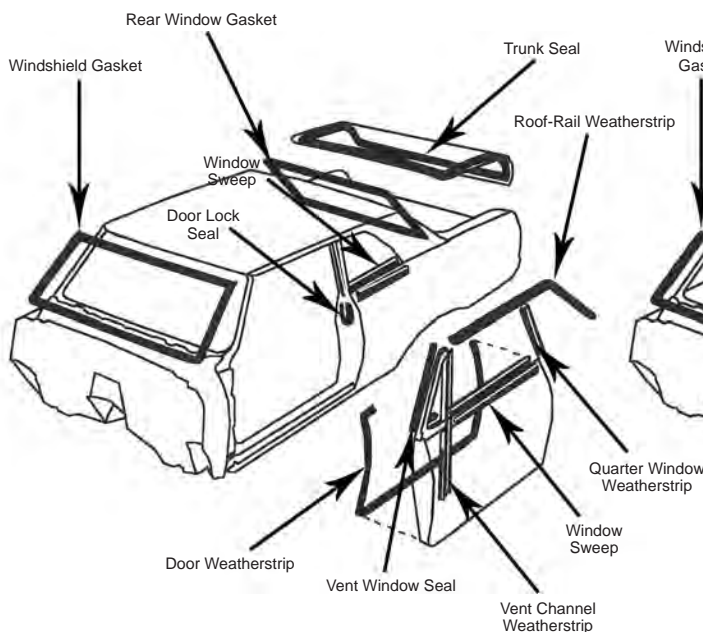

### CONVERTIBLE WEATHERSTRIPPING

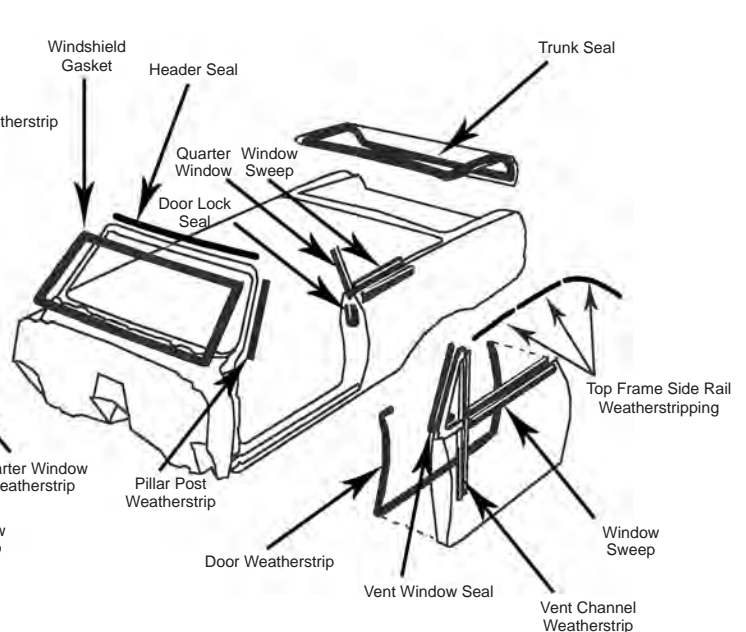

## ORIGINAL-STYLE WINDOW SWEEP KITS

Original-style window felts are reproduced with a factory look half-rounded metal bead on the inner and outer channels. Available as complete sets of (8) weather-strips for inner and outer door glass and quarter glass on 2-door models.

### 1964 Skylark

**WS64GKOWINDOWH** (Sport Coupe) ... \$164.00/kit  
**WS64GKOWINDOWC** (Convertible) ... \$164.00/kit  
**WS64GKOWINDOWS** (Coupe) ... \$164.00/kit

### 1965 Skylark & Gran Sport

**WS65GKOWINDOWH** (Sport Coupe) ... \$164.00/kit  
**WS65GKOWINDOWS** (Coupe) ... \$164.00/kit  
**WS65GKOWINDOWC** (Convertible) ... \$164.00/kit

### 1966-67 Skylark & Gran Sport

**WS66GKOWINDOWH** (Sport Coupe) ... \$195.00/kit  
**WS66GKOWINDOWS** (Coupe) ... \$195.00/kit  
**WS66GKOWINDOWC** (Convertible) ... \$195.00/kit

### 1966-67 Special

**WS66GKOWINDOWSS** (Coupe) ... \$131.00/kit

### 1968 Skylark & Gran Sport

**WS68GKOWINDOWH** (Sport Coupe) ... \$195.00/kit  
**WS68GKOWINDOWC** (Convertible) ... \$185.00/kit

### 1969 Skylark & Gran Sport

**WS69GKOWINDOWH** (Sport Coupe) ... \$195.00/kit  
**WS69GKOWINDOWC** (Convertible) ... \$195.00/kit

### 1970-72 Skylark & Gran Sport

**WS70GKOWINDOWH** (Sport Coupe) .. \$195.00/kit  
**WS70GKOWINDOWS** (Coupe) ... \$195.00/kit  
**WS70GKOWINDOWC** (Convertible) ... \$195.00/kit

## CONVERTIBLE TOP FRAME WEATHERSTRIPPING KITS

Complete convertible top frame kits consist of (1) rubber header seal and (6) molded rubber side rail pieces. (Header seal not shown)



### 1964-65 Skylark & Gran Sport

**WS64GA-ROOFC** (Convertible) ... \$449.00/kit

### 1966-67 Skylark & Gran Sport

**WS66GA-ROOFC** (Convertible) ... \$489.00/kit

### 1968-72 Skylark & Gran Sport

**WS68GA-ROOFC** (Convertible) ... \$449.00/kit

## HEADER SEALS

Rubber header seal runs along the front of the top and seals against the top of the windshield.

### 1964-65 Skylark & Gran Sport

**WS64GA-HS** (Convertible) ... \$49.00/ea.

### 1966-67 Skylark & Gran Sport

**WS66GA-HS** (Convertible) ... \$79.00/ea.

### 1968-72 Skylark & Gran Sport

**WS68GA-HS** (Convertible) ... \$99.00/ea.

## PILLAR POST WEATHERSTRIPPING

These weatherstrip pieces run along the side of the windshield frame A-pillar.

### 1964-65 Skylark & Gran Sport

**WS64GA-WSP** (Convertible) ... \$99.00/pr.

### 1966-67 Skylark & Gran Sport

**WS66GA-WSP** (Convertible) ... \$99.00/pr.

### 1968 Skylark & Gran Sport

**WS68GA-WSP** (Convertible) ... \$99.00/pr.

### 1969-72 Skylark & Gran Sport

**WS69GA-WSP** (Convertible) ... \$99.00/pr.

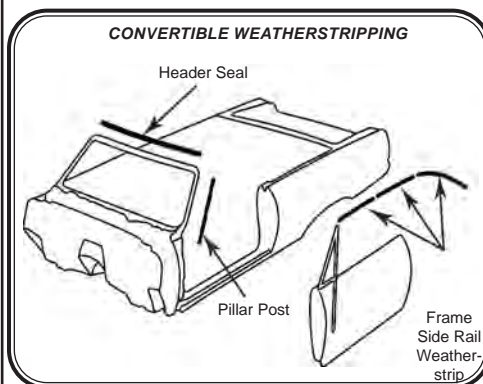

## PLASTIC HOOD PAD CLIPS



Reproduction plastic hood pad clips for all 1968-72 Skylark & Gran Sport models.

**HPGACLIP-P** ... \$1.00/ea.

## METAL HOOD PAD CLIPS



Reproduction of the original stamped metal hood pad clip for 1964-67 Skylark & Gran Sport models.

**HPGACLIP-M** ... \$3.00/ea.

## HOOD PAD INSULATION

Die-cut reproductions of the original hood pads come ready to install. These insulating pads help quiet engine noise and absorb heat.



### 1968-72 Skylark & Gran Sport

**HP68GK1** (shown) ... \$54.00/ea.

*Standard gray felt insulation.*



\*\*\*

Providing the automotive industry  
with the world's highest quality  
soft trim products and services  
RIGHT HERE AT HOME

\*\*\*

STILL ASSEMBLED AND  
MADE IN THE ★★★★★  
**USA** 

\*\*\*

THERE REALLY IS A DIFFERENCE!!

\*\*\*

*Legendary*  
**AUTO INTERIORS LTD.**

[www.legendaryautointeriors.com](http://www.legendaryautointeriors.com)



# ORDERING INFORMATION

## HOW TO ORDER

**MAIL, PHONE OR FAXES** – When ordering by mail, please fill in all information on the order form that pertains to your vehicle. Print all information and include a telephone number where you can be reached during the day and evening. When ordering for more than one vehicle, please use separate order forms for each vehicle (see order forms in your Legendary Auto Interiors catalog). When ordering by phone, please have your customer number and a list of items ready. You may order conveniently by phone 8:00AM to 6:00PM EST Monday-Friday. Orders may also be sent in by fax 24 hours a day, 7 days a week. Please note that orders faxed in on Saturday or Sunday will not be received and processed until Monday. FAX: 1-800-732-8874

**ON-LINE ORDERING** – Legendary Auto Interiors, Ltd also offers convenient and easy on-line ordering 24 hours a day, 7 days a week at [www.legendaryautointeriors.com](http://www.legendaryautointeriors.com). Click on the “Shop Online” tab in the options menu and follow the ordering procedures. Upon completion, Legendary Auto Interiors, Ltd will follow up with an email confirmation so you can verify that your order has been received correctly and is being processed. You may also choose to email your orders by contacting our sales department at [sales@legendaryautointeriors.com](mailto:sales@legendaryautointeriors.com).

## METHODS OF PAYMENT

**CREDIT CARDS** – Legendary Auto Interiors, Ltd accepts Visa, MasterCard, American Express and Discover for your convenience. Please include the cardholder’s name, billing address, home and business phone, credit card number, expiration date and the 3 or 4 digit security code when placing your orders. Without this information it may slow the processing of your order.

**CHECKS AND MONEY ORDERS** – Personal Checks will be held 5 business days. To expedite your orders, we suggest paying by Certified Bank Check or Money Order. COD orders are no longer accepted. All payments MUST be in U.S. funds.

## SHIPPING SERVICES

**DOMESTIC SHIPPING** - Legendary Auto Interiors Ltd utilizes both UPS and FedEx Ground for most U.S. parcel shipments which provides our customers the most efficient and cost effective shipping services available. We will ship by the best method for your geographic area unless otherwise specified. We also offer specialized shipping services such as 3 day Select, 2nd day air and Next Day Air for your convenience.

**INTERNATIONAL SERVICES** – We use the most current and most cost effective international parcel shipping companies available to provide both “Door to Airport” and “Door to Door” services to our overseas customers. We utilize UPS Canadian and FedEx International for Canadian shipments. This provides us with the best possible shipping and brokerage fees for our international customers.

## DAMAGES AND SHORTAGES

The carrier is responsible for any merchandise lost or damaged in transit. **Should a package appear to be damaged, OPEN the package while the carrier’s driver is present and note all damages and/or shortages.** If this is not possible and you discover damaged goods or shortages, contact our Customer Service Department immediately! Damages and/or shortage claims must be made within 5 days of receipt of merchandise to ensure our ability to file a claim with the carrier. Please be sure to check all merchandise when you receive it and again before attempting installation.

Legendary Auto Interiors, Ltd. is committed to providing the highest possible level of customer service, however on rare occasions circumstances beyond our control can result in lost or damaged packages. To protect our customers against delays and having to make time consuming phone calls to the carrier, orders will incur a modest \$2.50 insurance fee on each shipment. In the event any products become lost or damaged we will then send replacement parts as quickly as possible, subject to material availability. We will also file the claims and deal with the carrier.

Carriers allow a short period of time to file claims. To take advantage of this service you must notify Legendary Auto Interiors, Ltd. of any damages within 5 days of receiving your delivery. Failure to contact us within this 5 day window will negate Legendary Auto Interiors further involvement.

## RETURN POLICY

Legendary Auto Interiors Ltd. will accept returns within the first 30 days of the original invoice date. All items returned within the first 30 days will be subject to a restocking fee of 20-25% depending on item. No returns will be accepted after 30 days. Custom, Special Orders, Specialty Run Materials, Leather and NOS are not eligible for return under any circumstances other than a manufacturing defect. If any product is modified, altered, painted, installed or disassembled in any way without Legendary’s expressed written permission, the item is non-returnable. Legendary always recommends professional installation on all products. Any item which has been altered, painted, installed or deemed non-resalable by Legendary will be returned to the customer at the customer’s expense. Legendary is not responsible or liable for labor fees associated with the installation, modification or repair of any product purchased regardless of the circumstances.

## RETURN GOOD INFORMATION

All returns must receive prior approval and an RMA (Return Merchandise Authorization) number prior to return shipping. Packages received by Legendary Auto Interiors Ltd. without prior approval and RMA number will be refused. Return shipping and insurance are the customer’s responsibility. All returned items must be received in as new condition. Examples that render a product non-returnable include, but are not limited to: evidence of attempted installation, parts that have been bent, broken, creased, scratched, soiled, melted or discolored. Also, we will not accept returns for any items that have been altered, painted, repaired or for any reason that has rendered the product non-resalable. Warning: Legendary is not responsible for damaged or lost packages returned by the customer.

## CANADIAN CUSTOMER RETURNS

Warranty returns must be clearly marked as follows: **“U.S. GOODS BEING RETURNED FOR REPAIR OR REPLACEMENT UNDER WARRANTY COMMODITY CODE 9801:00V0”**.

## PRICES

All prices effective January 1st, 2026 and are subject to change without notice.

## HOURS

Monday – Friday 8:00AM to 5:30PM (Eastern Standard Time)

Saturday - By appointment only please

# IMPORTANT ADDITIONAL INFORMATION

## WARRANTY INFORMATION

Legendary Auto Interiors, Ltd proudly stands behind all of the products and services we offer. All Legendary manufactured sewn interior soft trim products are backed by an exclusive **Limited Lifetime Warranty** for as long as you own your car. In addition, we offer a 5-year warranty on all of our molded, die-electrically heat sealed and exterior soft trim products. Legendary Auto Interiors, Ltd also offers a huge selection of interior components, which we warranty for a maximum of 1 year in accordance with the original manufacturers product warranty. **Product Disclaimer: Normal wear from use or problems due to improper installation are excluded from any warranty.**

## LEGENDARY GUARANTEE

All Legendary Auto Interiors, Ltd manufactured products are made to original specifications and are guaranteed to fit. In the event that you experience a problem with any of our products or are dissatisfied with our service, we will make every effort to resolve and correct your issue promptly and do our best to make sure that you are completely satisfied.

## INTERIOR COLORS/GRAINS

Legendary Auto Interiors, Ltd offers one of the most diverse product lines available in the marketplace. We feature the correct "color matched" and "grain matching" materials for nearly all models and styles. Due to the extensive number of colors produced by Chrysler, AMC and General Motors, there are some colors, which are simply not available in reproduction form. As the demand for colors increases, we are constantly having previously unavailable colors reproduced. In the event that a vinyl or cloth is not available in reproduction form, the use of NOS material may be required. Please inquire for a current quote, as the price and availability of these NOS materials will vary. To ensure a correct color and grain match, your interior trim code may be required for verification. As color dye lots will vary, we recommend purchasing all your soft trim components at the same time to ensure an exact color match of all components throughout your interior. **Color and grain samples are available upon request at no charge.**

## LEATHER INTERIORS

Legendary Auto Interiors, Ltd produces a large number of "as original" leather interiors that are color matched to the original. Special order custom leather interiors are also available upon request. Some applications may require a clean, non-faded sample to ensure the closest possible color match. Leather interior orders may require additional lead-time as well as additional costs, which will be quoted at time of your order. **Note: Due to the variable nature of real leather, minor marks and features are normal and add to the character & individuality of leather products.**

## CUSTOM ORDERS

In addition to "As Original" reproduction interiors, Legendary Auto Interiors, Ltd specializes in and is proud to feature "CUSTOM" interiors servicing the Resto-Mod enthusiast. With the introduction of our new & exclusive *Legendary* product, custom orders have taken on an entirely new look and have given enthusiasts almost limitless options to create a one of a kind interior. Special Order and Custom interiors require approval for all designated materials being used and a signature approval on a "Custom Order" form is also required. Once the Custom work has been approved these orders must be prepaid and are Non-Returnable, Non-Refundable and Non-Cancelable.

## INSTALLATION NOTES

Since age deteriorates certain areas of seats due to wear patterns and foam breakdown, certain adjustments and foam repair may be required to complete a perfect fit installation. For this reason, we recommend having a professional automotive interior trim/upholstery shop install your new Legendary Auto Interiors, Ltd soft trim products. As the manufacturer, we know how to install our products better than anyone and we offer complete installation services for both seat upholstery and door panels. For further information, see the **INSTALLATION GUIDE** included with your seat upholstery and door panels or the installation page of this catalog.

## PRODUCT DEVELOPMENT & PATTERNS NEEDED

In an effort to develop new upholstery kits, door panels and other soft trim products we work hand in hand with many of our customers who provide their original parts for product development. These items must be ORIGINAL, in fair to good condition and have not been previously repaired or replaced in any way. Our Sales Department must be contacted directly before sending your old upholstery or other soft trim products to us. Since we have no idea about the usability of your parts until we receive them in, you may initially be asked to send photos in an effort to identify the condition of your original parts. Please remember that even if you send in your parts for inspection, we may not be able to use them. **PLEASE NOTE THAT OLD UPHOLSTERY AND OTHER SOFT TRIM ITEMS CANNOT BE RETURNED TO YOU, AS THEY WILL BE DISMANTLED FOR DEVELOPMENT USE.**

## MAINTENANCE

All Legendary Auto Interiors, Ltd products may be cleaned with a mild soap and warm water solution. Never scrub or use any kind of harsh pads, brushes or detergents. After cleaning with mild soap and water, lightly clean again with an industrial grade wax and grease remover. (Contact your local auto parts store) Allow surface to dry. LIGHTLY mist with the vinyl protectant of your choice. Install your new parts into your cruising machine. Sit back, enjoy the ride and drive safely!! Note: On leather upholstery applications we recommend using a high-quality mink oil, neatsfoot oil and/or wax. Hand apply, let stand 30-60 minutes and then wipe /buff clean. LIGHTLY rub your soft trim product with oil and wipe excess oil from the surface. **DO NOT USE SILICONE BASED PRODUCTS** as they will deteriorate the thread and dry out leather.

# INSTALLATION SERVICES

## GM, CHRYSLER & AMC SEAT UPHOLSTERY

*(Includes tear down of original upholstery and installation of new upholstery)*



Front Buckets Install - \$500.00/pr.  
(No Headrest Covers)



Front Buckets w/ Headrest Covers Install - \$600.00/pr.



Front Split Bench Install - \$575.00/ea.



Front Split Bench w/ Headrest Covers Install - \$675.00/ea.



Rear Bench Seat Install - \$400.00/ea.



Headrest Covers Install - \$150.00/pr.

Center Armrest Install - \$150.00/ea.  
(for models w/ buckets and no console)



## SAVE ON COMPLETE FRONT & REAR INSTALLS!!

Front Buckets & Rear Bench Seat Install - \$750.00/set

Front Buckets w/ Headrest Covers & Rear Bench Seat Install - \$850.00/set

Front Split Bench & Rear Bench Seat Install - \$825.00/set

Front Split Bench w/ Headrest Covers & Rear Bench Seat Install - \$925.00/set

*\*NOTE\* Basic installations DO NOT include new foam and cotton replacement or reconstruction, media blasting, painting, welding, frame straightening, polishing or trim detailing. These services are additional and available at an hourly rate. Please call for more details. 1-800-363-8804*

# INSTALLATION SERVICES

## GM, CHRYSLER & AMC DOOR PANELS

### Basic Door Panel Installation

(Includes installation of metal rails and window weatherstrip)

\*Convertible rear panel installation DOES NOT include ashtray/well covers  
\*Ashtray/well covers for General Motors models are available. Call for details



Front Panels (Pair Only) - \$250.00/pr.



Hardtop/Convertible Rear Panels (Pair Only) - \$250.00/pr.

Complete Front & Rear Panels (Pairs Only) - \$500.00/pr.

### Deluxe Door Panel Installation

(Includes installation of metal rails, window weatherstrip, metal trim and decorative emblems)

\*Convertible rear panel installation DOES NOT include ashtray/well covers  
\*Ashtray/well covers for General Motors models are available. Call for details



Front Panels (Pair Only) - \$400.00/pr.



Hardtop/Convertible Rear Panels (Pair Only) - \$325.00/pr.

Complete Front & Rear Panels (Pairs Only) - \$725.00/pr.

## DOOR PANEL REFURBISHMENT

If we do not list your particular year/make/model vehicle, Legendary Auto Interiors, Ltd. can refurbish your panels back to original for you. The following refurbishing rates include installation of new panels (on your original metal rails), inner window weatherstripping, metal trim and decorative emblems. Please call for instructions before shipping your door panels.

Front Panels (Pair Only) - \$750.00/pr.

Hardtop/Convertible Rear Panels (Pair Only) - \$500.00/pr.

Complete 2-Door Front & Rear Panels (Pairs Only) - \$1250.00/set

Complete 4-Door Front & Rear Panels (Pairs Only) - \$1250.00/set

\*NOTE\* Custom refurbishing does not include the refinishing of metal trim and decorative emblems. We highly recommend this work is done before sending the panels.





# SHIPPING/HANDLING RATE CHART

| <u>Order Value \$</u> | <u>Flat Rate</u> | <u>Oversize Charges</u>   | <u>Rate</u> |
|-----------------------|------------------|---|-------------|
| 01-40                 | \$11             | OS1   | \$26        |
| 41-100                | \$23             | OS2   | \$51        |
| 101-200               | *\$34            | OS3   | \$75        |
| 201-400               | *\$43            | *On all orders over \$100   |             |
| 401-600               | *\$58            | *NYS Customers - Sales tax will be added                          |             |
| 601-800               | *\$78            | *AK, HI, PR & International customers call for shipping           |             |
| 801-1000              | *\$113           | *Next Day, 2nd Day & 3 Day Select shipping, please call for rates |             |
| 1001-1250             | *\$165           |   |             |
| 1251-1500             | *\$172           |   |             |
| 1501-1850             | *\$216           |   |             |
| 1851-2100             | *\$259           |   |             |
| 2101-2500             | *\$296           |   |             |
| 2501-2999             | *\$334           |   |             |
| 3000-up               | *\$370           |   |             |

\*Includes \$3.50 for insurance

| <u>Oversize Items</u>      | <u>Classification</u>   | <u>Oversize Items</u>  | <u>Classification</u> |
|----------------------------|---|------------------------|-----------------------|
| Package Tray               | OS1   | Molded Headliners      | OS3                   |
| Trunk Divider              | OS1   | Molded Hood Pads       | OS3                   |
| Plastic Door Panels        | OS1   | Pick Up Seat Back Kits | OS3                   |
| Pre-Assembled Door Panels  | OS1   | GM Bench Seat Foam     | OS3                   |
| 2nd Gen F-Body Door Panels | OS1  | E-Body Dash Pads/Caps  | OS3                   |
| Consoles                   | OS1   | Trunk Packages         | OS3                   |
| Bucket Molded Foam         | OS1   |                        |                       |
| Install Kits 2-4, 12-15    | OS1   |                        |                       |
| Vinyl Yardage (1yd & up)   | OS1   |                        |                       |

| <u>Oversize Items</u>              | <u>Classification</u>   |
|------------------------------------|---|
| C-Body Carpet Kits                 | OS2   |
| 62-65 B Body Mopar Carpet Kits     | OS2   |
| 64-69 Cuda Fastback Carpet Kits    | OS2   |
| 66-67 Charger Fastback Carpet Kits | OS2  |
| Carpet Yardage                     | OS2   |
| Sound Dampeners                    | OS2   |
| Firewall Insulation                | OS2   |
| Convertible Glass                  | OS2   |
| Install Kit 5                      | OS2   |

# 2026 TENTATIVE SHOWS AND DATES

*Spring Carlisle*  
*Chryslers @ Carlisle*  
*Fall Carlisle*  
*SEMA*

*Carlisle, PA*  
*Carlisle, PA*  
*Carlisle, PA*  
*Las Vegas, NV*

*April 22 - 26, 2026*  
*July 10 - 12, 2026*  
*Sept 30 - Oct 4, 2026*  
*November 3 - 6, 2026*

Legendary Auto Interiors Ltd. welcomes the opportunity to support the smaller clubs' and organizations' car shows and swap meets. A variety of flyers, catalogs and gift certificates are available to clubs and organizations who sponsor shows nationwide. Please call or write for additional information. The list above is a tentative schedule subject to change without notice. Come visit us at many car shows/swap meets and see what makes a Legendary interior... truly Legendary.



**Legendary**  
**AUTO INTERIORS LTD.**

# Table of Contents - Skylark & Gran Sport

## **SEAT UPHOLSTERY & TRIM ACCESORIES 11-119**

|   |     |                                       |         |
|---|-----|---------------------------------------|---------|
| Bench Seatback Release Knob.....        | 116 | Bucket Seat Spring Assembly .....     | 116     |
| Bucket Seat Back Panels .....           | 118 | Cotton Rolls .....                    | 117     |
| Bucket Seat Back Release Buttons.....   | 117 | Headrest Covers.....                  | 113-115 |
| Bucket Seat Bases .....                 | 118 | High Density Foam .....               | 117     |
| Bucket Seat Chrome Trim .....           | 118 | Hog Ring Plier Kits .....             | 117     |
| Bucket Seat Headrests.....              | 116 | Muslin .....                          | 117     |
| Bucket Seat Headrest Lock Assembly..... | 117 | Seat Adjustment Knobs .....           | 116     |
| Bucket Seat Headrest Mounting Kit.....  | 116 | Seat Back Bumpers.....                | 116     |
| Bucket Seat Hinge End Cap.....          | 117 | Seat Bottom Stretch Panel Boards..... | 117     |
| Bucket Seat Mount Conversion Brackets.  | 116 | Seat Upholstery .....                 | 112-115 |

## **MOLDED FOAM & FOAM ACCESORIES 119-122**

|  |     |
|--|-----|
| Installation Services.....             | 122 |
| Molded Foam.....                       | 120 |
| Seat Upholstery Installation Kits..... | 121 |

## **DOOR PANELS & TRIM ACCESORIES 123-137**

|  |         |   |     |
|--|---------|---|-----|
| Armrest Bases .....                      | 133     | Door Panel Trim Molding.....              | 135 |
| Armrest Base Chrome Back Plate.....      | 133     | Door Panel Watershields.....              | 137 |
| Armrest Base Molding .....               | 134     | Door Panel Windlace.....                  | 135 |
| Armrest Base Screw Set .....             | 134     | Door Sill Plates .....                    | 137 |
| Armrest Pads.....                        | 133     | Door & Window Handle Plastic Washer ..... | 136 |
| Ashtrays.....                            | 134     | Door & Window Handle Retaining Clip.....  | 136 |
| Armrest/Ashwell Covers .....             | 124-133 | Hinge to Door Bolts .....                 | 134 |
| Ashwell Installation Pad Kits.....       | 134     | Jute Backing.....                         | 137 |
| Conv. Courtesy Light Lens & Bezels ..... | 134     | Lower Door Hinge Pins.....                | 137 |
| Door Handles .....                       | 136     | Lower Door Spring.....                    | 137 |
| Door Hinges.....                         | 137     | Seat Belt Bolts .....                     | 137 |
| Door Jamb Windlace .....                 | 135     | Upper Door Jamb End Caps .....            | 135 |
| Door Lock Ferrules .....                 | 135     | Vent Window Cranks .....                  | 136 |
| Door Lock Knobs .....                    | 135     | Vent Window Handles .....                 | 136 |
| Door Lock Striker.....                   | 137     | Window Crank Handles .....                | 136 |
| Door Panels.....                         | 124-131 | Window Handles Springs .....              | 136 |
| Door Panel Clips & Retainers.....        | 135     |   |     |
| Door Panel Emblems.....                  | 137     |   |     |

## **CARPETS, FLOORMATS & ACCESORIES 139-149**

|                             |         |                              |     |
|-----------------------------|---------|------------------------------|-----|
| Carpet.....                 | 142     | Floormat Color Selector..... | 146 |
| Carpet Color Selector ..... | 141     | Kick Panels.....             | 142 |
| Carpeted Floormats.....     | 149     | Kick Panel Carpet.....       | 142 |
| Carpet Yardage .....        | 142     | Kick Panel Insulation .....  | 142 |
| Floormats.....              | 147-148 | Sound Deadener .....         | 142 |
|                             |         | Sound Dampening.....         | 142 |

## **DASHES, CONSOLES, SHIFTERS & ACCESORIES 154-156**

|                               |     |                              |     |
|-------------------------------|-----|------------------------------|-----|
| Console & Dash Inserts.....   | 155 | Pedal Pads & Bezels .....    | 155 |
| Dash Pad Emblems.....         | 156 | Shifter Boots.....           | 156 |
| Firewall Guard Fastener ..... | 156 | Steering Column Covers ..... | 156 |
| Firewall Insulation.....      | 156 | Steering Column Seal.....    | 156 |
| Gas Pedal Rod Pin.....        | 155 | Underdash Insulation.....    | 156 |
| Gas Pedal Spring .....        | 155 |                              |     |
| Glovebox Liners.....          | 155 |                              |     |

# Table of Contents - Skylark & Gran Sport

## **HEADLINERS & TRIM ACCESORIES 157-162**

|                                     |     |                                  |     |
|-------------------------------------|-----|----------------------------------|-----|
| Dome Light Lens & Bezels .....      | 160 | Pillar Post Moldings .....       | 160 |
| Convertible Sunvisor Brackets ..... | 162 | Rear Window Trim .....           | 159 |
| Courtesy Light Lens & Bezels .....  | 160 | Sail Panel Boards .....          | 160 |
| Headliners .....                    | 159 | Sunvisors .....                  | 162 |
| Headliner Bow Retainer Clips .....  | 159 | Sunvisor Supports .....          | 162 |
| Headliner Color Selector .....      | 158 | Sunvisor Tip & Bushing Kit ..... | 162 |
| Headliner Insulation .....          | 159 | Upper Windshield Trim .....      | 159 |

## **PACKAGE TRAY AND TRUNK ACCESORIES 163-166**

|                                       |         |
|---------------------------------------|---------|
| Package Tray & Jute Insulation .....  | 164-165 |
| Spare Tire Cover & Board .....        | 166     |
| Trunk Area Speaker Cover .....        | 166     |
| Trunk Divider & Jute Insulation ..... | 166     |
| Trunk Mats .....                      | 166     |
| Trunk Mat Material .....              | 166     |

## **VINYL TOPS, CONVERTIBLE TOPS & ACCESORIES 167-172**

|   |     |
|---|-----|
| Convertible Body Screw Studs .....        | 172 |
| Convertible Boots .....                   | 172 |
| Convertible Header Panel Vinyl .....      | 171 |
| Convertible Tops .....                    | 169 |
| Convertible Top Color Selector .....      | 169 |
| Convertible Top Guide Pin .....           | 171 |
| Convertible Top Latch Hooks .....         | 171 |
| Convertible Top Latch Hook Knuckles ..... | 171 |
| Convertible Top Motor Cover .....         | 171 |
| Convertible Top Pads .....                | 171 |
| Convertible Top Plastic Guide Pins .....  | 171 |
| Convertible Top Tension Cables .....      | 171 |
| Convertible Well Liners .....             | 172 |
| Vinyl Tops .....                          | 168 |

## **WEATHERSTRIPPING & ACCESORIES 173-175**

|  |     |
|--|-----|
| Convertible Top Frame Weatherstrip Kit ..... | 175 |
| Door Lock Seals .....                        | 174 |
| Door Weatherstripping .....                  | 174 |
| Header Seals .....                           | 175 |
| Hood Pad Clips .....                         | 175 |
| Hood Pad Insulation .....                    | 175 |
| Hood to Cowl Seals .....                     | 174 |
| Pillar Post Weatherstripping .....           | 175 |
| Rear Quarter Window Seals .....              | 174 |
| Roof Rail Weatherstripping .....             | 174 |
| Trunk Seals .....                            | 174 |
| Window Sweep Kits .....                      | 175 |



# OVER 225 DIFFERENT INTERIOR STYLES OFFERED FOR CHRYSLER & AMC

1957-76 MOPAR A,B,C,E & F-BODY, 1963-68 DODGE A-100 VAN  
1973-79 DODGE TRUCK & 1968-74 AMC JAVELIN/AMX

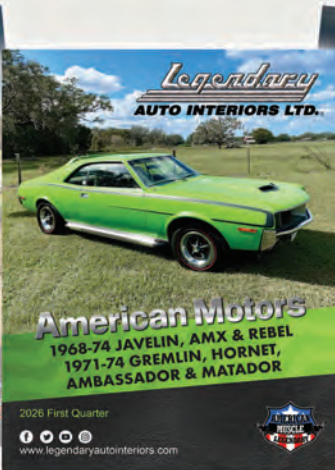
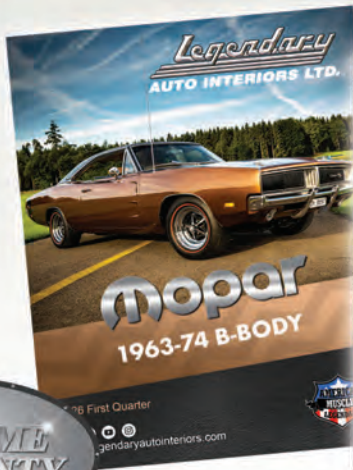

WWW.LEGENDARYAUTOINTERIORS.COM

Legendary Auto Interiors, Ltd.  
121 West Shore Blvd  
Newark, NY 14513

# We're Social!

 [facebook.com/legendaryautointeriors](https://facebook.com/legendaryautointeriors)

 [youtube.com/user/legendaryauto](https://youtube.com/user/legendaryauto)

 [x.com/legendaryautoin](https://x.com/legendaryautoin)

 [instagram.com/legendaryautointeriorsltd](https://instagram.com/legendaryautointeriorsltd)



**LEGENDARY AUTO INTERIORS**  
**1-800-363-8804**  
**WWW.LEGENDARYAUTOINTERIORS.COM**