

Legendary

AUTO INTERIORS LTD.



Chevrolet

**1964-72 CHEVELLE, MALIBU
& EL CAMINO**

2026 Second Quarter



www.legendaryautointeriors.com





WE'RE NOT JUST CHRYSLER ANYMORE!

1964-72 CHEVELLE/EL CAMINO, GTO/LEMANS, CUTLASS/442 & SKYLARK/GS
1970-72 MONTE CARLO, 1970-72 NOVA & 1967-81 CAMARO & FIREBIRD

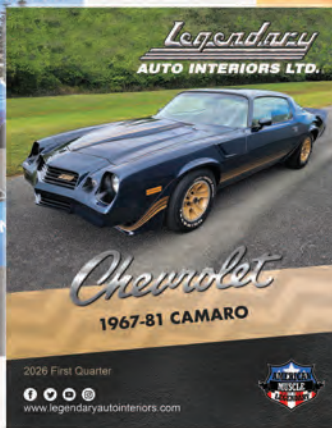

WWW.LEGENDARYAUTOINTERIORS.COM

A Special Message from the President...

For over 4 decades, Legendary Auto Interiors, Ltd has been committed to providing the automotive restoration industry and enthusiast with the world's highest quality soft trim products and services. Available from the most authentic "As Original" interiors to the most extreme "One of a Kind" Custom Resto-Mod interiors, Legendary has been relied upon and Legendary has delivered!

This past decade has been extremely exciting! We continue to set the bar and truly lead by example, establishing industry expectations and standards. Introducing innovative tools such as our exclusive "Custom Design Center", "LegendImagery™" and "Sample Request Center". Whether your preference is "As Original" or a creation of your own vision, we have created a destination where you can let your imagination lead the way! Our commitment to developing and maintaining innovative solutions is a dedicated process that will continue to provide you with great products, service and help grow our restoration industry.

We are looking forward to a very productive future. As owner and President and from all of our proud team here at Legendary Auto Interiors LTD, we would like to thank you for allowing us the opportunity and the privilege of being your automotive soft trim supplier.

Thank you once again for your business, interest and support!

Sincerely yours,

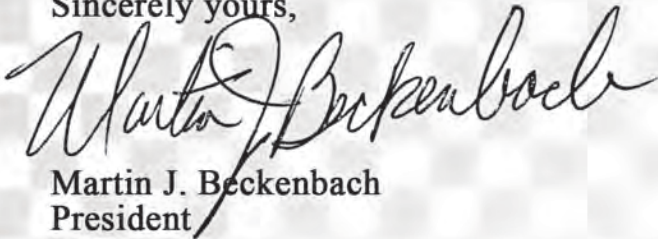

Martin J. Beckenbach
President

PRODUCT DISCLAIMER: Products listed in this catalog have been reproduced and/or remanufactured to resemble original products. All manufacturers names and descriptions are used for reference purposes only. It is therefore understood that the products listed in this catalog are in fact REPRODUCTIONS unless specified otherwise. All parts described and offered for sale in this publication as NOS (New Old Stock) are new parts/materials manufactured by or for Chrysler LLC and General Motors Corporation.

All literature produced by and directly related to Legendary Auto Interiors Ltd., is protected under copyright laws.
All literature cannot be reproduced for any reason unless prior permission is obtained.



FLEX TREAD®

YOU ASK FOR IT...WE DELIVERED!!



YOU ASK FOR IT...WE DELIVERED!!



Flextread is providing the most innovative
molded floormats in the industry

RIGHT HERE AT HOME!

All products are 100% assembled, designed
and made in the U.S.A.



THE NEXT GENERATION IN FLOORMATS™

FLEXTREAD®

BOOTMAT COLORS



001 - Black



007 - Dark Blue



011 - Medium Blue



018 - Bright Red



020 - Red



051 - Lime Green



023 - Tan



031 - Maroon



050 - Turquoise



054 - Purple



057 - Dark Olive Green



074 - Pink



079 - Grey



098 - Brown



129 - Dark Saddle



132 - Gold

CAMOUFLAGE



200 - Rugged Woods



202 - Cyberflage



PATENTED

SCENERY BOOT MATS

MANY KOOL SCENES
AVAILABLE AND
MORE COMING SOON!



DUCK SCENE



BEAR SCENE



4X4 SCENE



TURKEY SCENE



FISHING SCENE



WHITETAIL SCENE



EQUINE SCENE



SCORCHED EARTH &
TIRE TRACK SCENE



TREE SCENE

FLEXTREAD®

1-833-700-3539 EXT. 222
WWW.FLEXTREADMATS.COM



Providing the automotive industry
with the world's highest quality
soft trim products and services
RIGHT HERE AT HOME

STILL ASSEMBLED AND
MADE IN THE ★★★★★
USA 

THERE REALLY IS A DIFFERENCE!!

Legendary
AUTO INTERIORS LTD.

www.legendaryautointeriors.com



INTRODUCING THE BEST WARRANTY COVERAGE IN THE INDUSTRY!!

Limited Lifetime Warranty

Limited Warranty - Legendary Auto Interiors Ltd. (called "we") warrants that the products it manufactures will be free of defects in materials and workmanship from the date it is first purchased by the retail purchaser. A retail purchaser is any person or any entity who or which purchases the product but does not do so for resale.

Warranty Information - Legendary Auto Interiors, Ltd proudly stands behind all of the products and services we offer. All Legendary manufactured sewn interior soft trim products are backed by an exclusive Limited Lifetime Warranty for as long as you own your car. In addition, we offer a 5-year warranty on all of our molded, die-electrically heat sealed and exterior soft trim products. Legendary Auto Interiors, Ltd also offers a huge selection of interior components, which we warranty for a maximum of 1 year in accordance with the original manufacturers product warranty.

Obligation - If a product is not as warranted, we will either repair or, at our option, replace the defective product. If repair or replacement is not possible within a reasonable time, we will refund the purchase price.

Exclusions from Warranty - This Warranty does not apply to:

1. Conditions resulting from the product being altered, abused, misused, damaged by accident or negligence; being repaired without our authorization; or not being maintained properly in accordance with written instructions provided with the product.
2. Conditions resulting from ordinary wear and tear or including, without limitation, exposure to ultraviolet light.
3. Conditions resulting from the use of Specialty Run Materials (SRM) supplied by the purchaser.
4. Conditions resulting from improper installation by the purchaser or anyone else outside of our control.

Disclaimer - EXCEPT FOR THE LIMITED WARRANTY DESCRIBED ABOVE, WE OFFER NO WARRANTIES, EXPRESSED OR IMPLIED, AND OTHER THAN THE LIMITED WARRANTY EXPRESSLY CONTAINED HEREIN, WE HEREBY DISCLAIM ANY AND ALL WARRANTIES, INCLUDING WITHOUT LIMITATION ANY IMPLIED WARRANTIES OF MERCHANTABILITY, SUITABILITY OR FITNESS FOR A PARTICULAR PURPOSE. Some states do not allow limitations on how long an implied warranty lasts, so the above limitation may not apply to you.

Exclusion of Incidental and Consequential Damages - WE ARE NOT RESPONSIBLE FOR ANY INCIDENTAL OR CONSEQUENTIAL DAMAGES RESULTING FROM BREACH OF THE LIMITED WARRANTY DESCRIBED ABOVE. Some states do not allow the exclusion or limitation of incidental or consequential damages, so the above limitation or exclusion may not apply to you.

Other Legal Rights - This Warranty gives you specific legal rights, and you may also have other rights which vary from state to state.

What To Do If You Have A Warranty Claim - If you have a warranty claim, you must call our sales office for further assistance. Once given a return authorization number please indicate the number on the box and return the product to our facility; Legendary Auto Interiors 121 West Shore Blvd, Newark, NY 14513. We will perform our warranty obligation within a reasonable amount of time after the returned product arrives at our facility.

Eff. 08/01/2024



PRODUCT DISCLAIMER: Products listed in this catalog have been reproduced and/or remanufactured to resemble original products. All manufacturers names and descriptions are used for reference purposes only. It is therefore understood that the products listed in this catalog are in fact REPRODUCTIONS unless specified otherwise. All parts described and offered for sale in this publication as NOS (New Old Stock) are new parts/materials manufactured by or for Chrysler Group LLC and General Motors Corporation.

LEGENDARY AUTO INTERIORS LTD., COPYRIGHT 2026

All literature produced by and directly related to Legendary Auto Interiors Ltd., is protected under copyright laws. All literature cannot be reproduced for any reason unless prior permission is obtained.

Vinyl Grain Chart

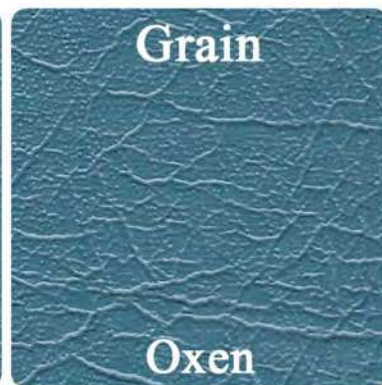
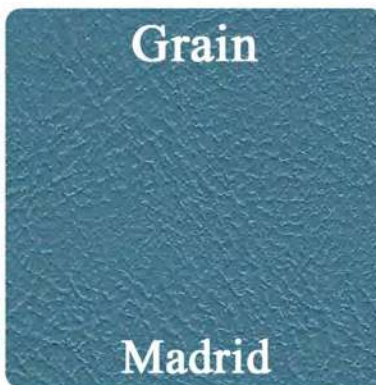
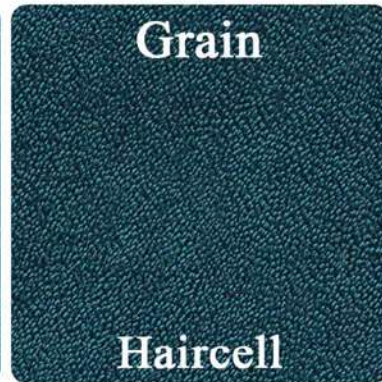
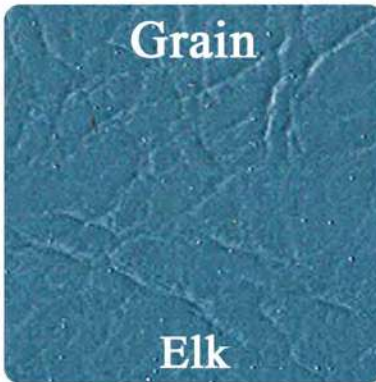
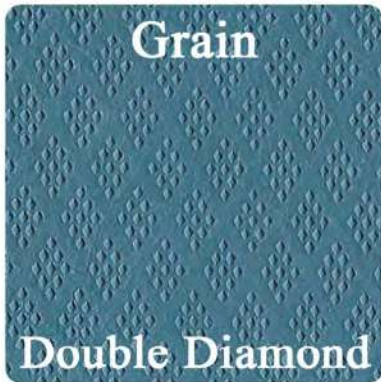
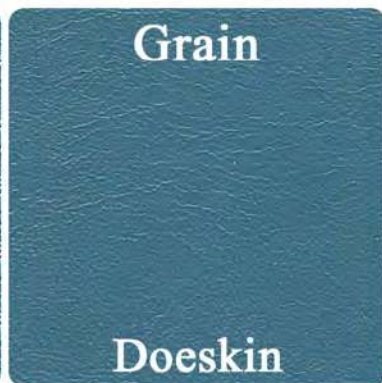
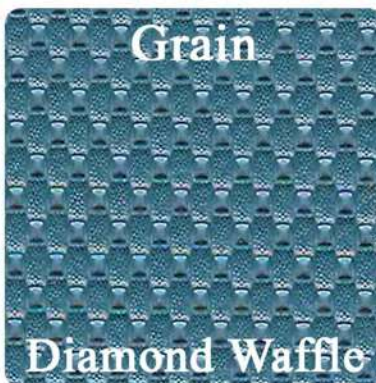
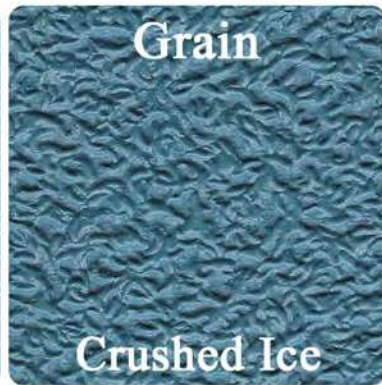

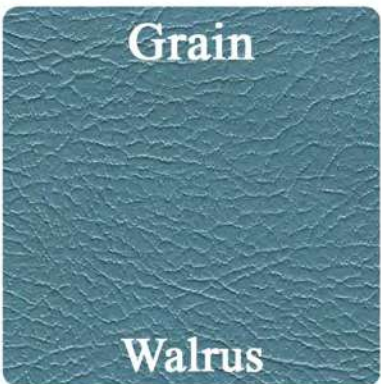
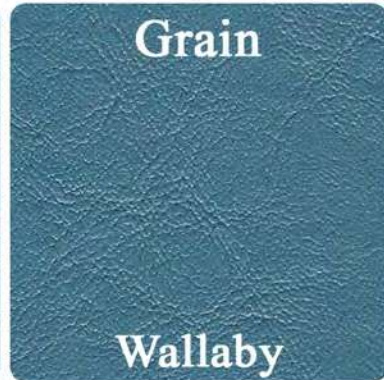
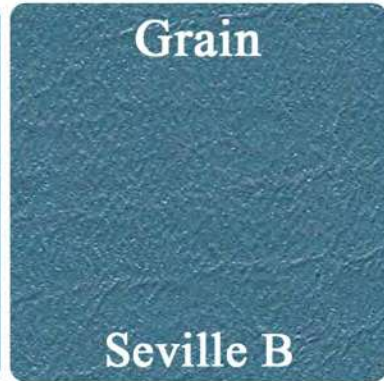
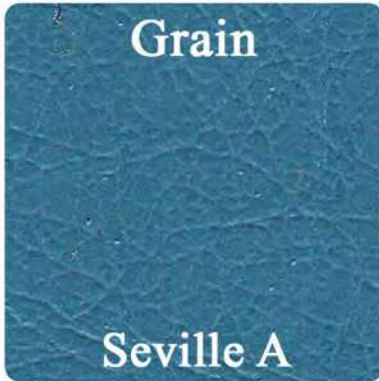
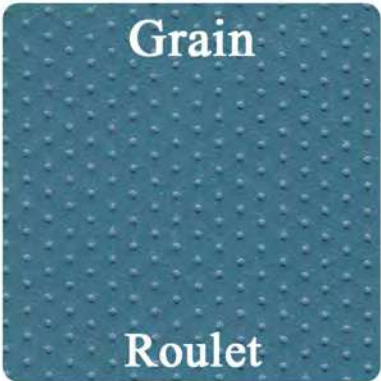
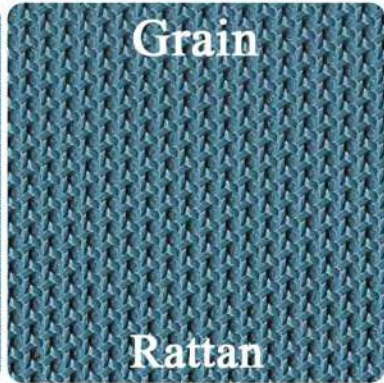
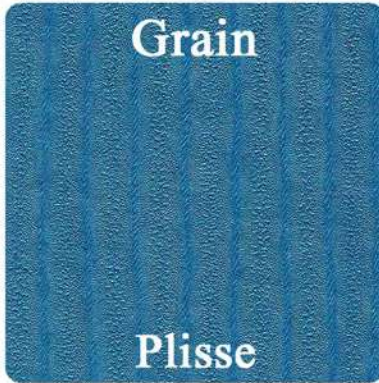

Vinyl Grain Chart





Vinyl Yardage

The following grains are available off the roll and come in 1/2 yard increments **ONLY**

Ascot
 VVYDASCOT(C) (1 Yard).....\$64.00/yd. 
 VV1/2YDASCOT(C) (1/2 Yard).....\$32.00/ea.
 Available colors: 100

Bison
 VVYDBISON(C) (1 Yard).....\$64.00/yd. 
 VV1/2YDBISON(C) (1/2 Yard).....\$32.00/ea.
 Available colors: 100, 204, 314, 510, 606, 610

Coachman
 VVYDCOACHMAN(C) (1 Yard).....\$64.00/yd. 
 VV1/2YDCOACHMAN(C) (1/2 Yard).....\$32.00/ea.
 Available colors: 100, 130, 140, 200, 330, 338, 340, 432, 434, 452, 528, 540, 550, 560, 640, 650, 656, 664, 666, 670

Cologne
 VVYDCOLOGNE(C) (1 Yard).....\$64.00/yd. 
 VV1/2YDCOLOGNE(C) (1/2 Yard).....\$32.00/ea.
 Available colors: 100, 102, 10A, 202, 318, 320, 332, 414, 420, 430, 520, 526, 614, 620, 636

Doeskin
 VVYDDOESKIN(C) (1 Yard).....\$64.00/yd. 
 VV1/2YDDOESKIN(C) (1/2 Yard).....\$32.00/ea.
 Available colors: 100, 104, 200, 206G, 508G

Dorchester
 VVYDDORCHESTER(C) (1 Yard).....\$64.00/yd. 
 VV1/2YDDORCHESTER(C) (1/2 Yard).....\$32.00/ea.
 Available colors: 100, 202

El Paso
 VVYDELPASO(C) (1 Yard).....\$64.00/yd. 
 VV1/2YDELPASO(C) (1/2 Yard).....\$32.00/ea.
 Available colors: 100, 200

Krinkle
 VVYDKRINKLE(C) (1 Yard).....\$64.00/yd. 
 VV1/2YDKRINKLE(C) (1/2 Yard).....\$32.00/ea.
 Available colors: 100, 154

Madrid
 VVYDMADRID(C) (1 Yard).....\$64.00/yd. 
 VV1/2YDMADRID(C) (1/2 Yard).....\$32.00/ea.
 Available colors: 100G, 202G, 204G, 210G, 220G, 230G, 235G, 239G, 240G, 310G, 325G, 331G, 333G, 334G, 338G, 342G, 343G, 351G, 369G, 380G, 415G, 420G, 421G, 424G, 429G, 448G, 460G, 465G, 469G, 501G, 511G, 513G, 520G, 631G, 635G, 640G, 642G, 645G, 650G, 651G, 657G, 658G, 670G, 679G, 683G, 690G, 694G, 695G, 697G, 709G, 710G

Oxen
 VVYDOXEN(C) (1 Yard).....\$64.00/yd. 
 VV1/2YDOXEN(C) (1/2 Yard).....\$32.00/ea.
 Available colors: 100

Oxford
 VVYDOXFORD(C) (1 Yard).....\$64.00/yd. 
 VV1/2YDOXFORD(C) (1/2 Yard).....\$32.00/ea.
 Available colors: 100, 200, 264, 360, 450

Ranger
 VVYDRANGER(C) (1 Yard).....\$64.00/yd. 
 VV1/2YDRANGER(C) (1/2 Yard).....\$32.00/ea.
 Available colors: 100, 200

Shallow Elk
 VVYDSHALLOWELK(C) (1 Yard).....\$64.00/yd. 
 VV1/2YDSHALLOWELK(C) (1/2 Yard).....\$32.00/ea.
 Available colors: 100, 156, 200, 202G, 230G, 341

Sierra
 VVYDSIERRA(C) (1 Yard).....\$64.00/yd. 
 VV1/2YDSIERRA(C) (1/2 Yard).....\$32.00/ea.
 Available colors: 100G, 102G, 200G, 209G, 319G, 528G, 684G, 688G

1 YARD AND MORE IS SHIPPED OVERSIZED 1

Specialty Grain Vinyl Yardage



All grain/color combinations not listed above can be produced upon request.
 Available in 1/2 yd or 1yd sheets **ONLY**



1/2 Yard (54"x18")
 TTMOLDSMALL.....\$36.00/ea.
 * Need to specify grain and color

1 Yard (54"x36")
 TTMOLDXL.....\$96.00/ea. 
 * Need to specify grain and color



UPHOLSTERY AND TRIM ACCESORIES

 facebook.com/legendaryautointeriors
 twitter.com/legendaryautoin

 www.legendaryautointeriors.com
 instagram.com/legendaryautointeriorsltd
 youtube.com/user/legendaryauto

1964 CHEVELLE/MALIBU & EL CAMINO



Heat Sealed Emblem on Rear Center Panel

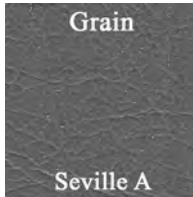

(C) COLOR CODES:

- (100G) Black - Chevelle Only
- (220G) Frost White - Chevelle Only
- (231G) Fawn
- (325G) Metallic Blue - Chevelle Only
- (419G) Light Aqua
- (508G) Red
- (656G) Saddle - Chevelle Only

This Legendary product features as-original heat sealed Seville grain inserts and Seville grain skirts. Rear seat top center panel features heat sealed Chevrolet bowtie and emblem as-original.

Front Buckets	AA64GHE0010(C)
100G, 220G, 325G, 508G ...	\$551/pr.
231G, 419G	\$1346/pr. (L1)
656G	\$579/pr. (L4)
☞ Molded foam is available for this model. Please see the "GM Molded Foam" section in this catalog.	

Hardtop Rear	AA64GH00048(C)
100G, 220G, 325G, 508G ...	\$323/ea.
231G, 419G	\$1140/ea. (L1)
656G	\$339/ea. (L4)

Convertible Rear.....	AA64GH00056(C)
100G, 220G, 325G, 508G ...	\$323/ea.
231G, 419G	\$1140/ea. (L1)
656G	\$339/ea. (L4)

Convertible Rear Bench Back Panel	SK64GA00019(C)
100G, 220G, 508G	\$79/pr.
656G	\$83/pr. (L4)
231G, 419G	\$247/pr. (L1)

1965 CHEVELLE/MALIBU & EL CAMINO

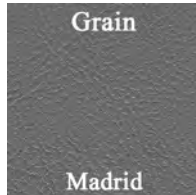

(C) COLOR CODES:

- (100G) Black - Chevelle Only
- (141G) Charcoal Blue/Slate - Chevelle Only
- (220G) Frost White - Chevelle Only
- (322G) Dk. Met. Blue/Lt. Met. Blue - Chevelle Only
- (422G) Aqua/NOS Lt. Met. Aqua - El Camino Only
- (507G) Dark Red/Red
- (638G) Gold/Fawn
- (639G) Gold Fawn
- (686G) Met. Brown/Saddle - Chevelle Only

This Legendary product features as-original Madrid grain inserts and Madrid grain skirts.

Front Buckets	AA65GHE0010(C)
100G, 220G, 322G	\$501/pr.
422G, 639G	\$1040/pr. (L1)
141G, 686G	\$1308/pr. (L1)
507G, 638G	\$526/pr. (L4)
☞ Molded foam is available for this model. Please see the "GM Molded Foam" section in catalog.	

Hardtop Rear	AA65GH00048(C)
100G, 220G, 322G	\$323/ea.
639G	\$1017/ea. (L1)
141G, 686G	\$1170/ea. (L1)
507G, 638G	\$339/ea. (L4)

Convertible Rear.....	AA65GH00056(C)
100G, 220G, 322G	\$323/ea.
639G	\$1017/ea. (L1)
141G, 686G	\$1170/ea. (L1)
507G, 638G	\$339/ea. (L4)

Conv Rear Bench Back Panel....	SK65GA00019(C)
100G, 220G, 235G, 335G, 338G, 424G, 501G	\$79/pr.
651G	\$83/pr. (L4)
420G, 140G, 232G, 679G	\$247/pr. (L1)

1966 CHEVELLE/MALIBU & EL CAMINO "OEM STYLE"



(C) COLOR CODES:

- (100G) Black
- (220G) Frost White - Chevelle Only
- (338G) Bright Blue - Chevelle Only
- (511G) Red
- (526G) Metallic Bronze - Chevelle Only
- (673G) Fawn / Parchment

This Legendary product features as-original Madrid grain inserts and Madrid grain skirts.

NOTE: Customer must reuse original metal medallions. Medallions are available. See following section of catalog.

Front Buckets	AA66GHE0010(C)
100G, 220G, 338G, 511G	\$501/pr.
526G	\$1308/pr. (L1)
673G	\$526/pr. (L4)
☞ Molded foam is available for this model. Please see "GM Molded Foam" section in this catalog.	

Hardtop Rear	AA66GH00048(C)
100G, 220G, 338G, 511G	\$323/ea.
526G	\$1187/ea. (L1)
673G	\$339/ea. (L4)

Convertible Rear.....	AA66GH00056(C)
100G, 220G, 338G, 511G	\$323/ea.
526G	\$1187/ea. (L1)
673G	\$339/ea. (L4)

Headrest Covers.....	HC66GA00N14(C)
(All Colors).....	\$82/pr.

Conv Rear Bench Back Panel....	SK65GA00019(C)
100G, 220G, 338G, 511G, 526G.....	\$79/pr.



1966 CHEVELLE/MALIBU & EL CAMINO RALLYE SEAT

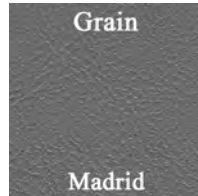

(C) COLOR CODES:
 (100G) Black
 (220G) Frost White - Chevelle Only
 (338G) Bright Blue - Chevelle Only
 (511G) Red
 (673G) Fawn / Parchment

Front Buckets **RS66GHE0010(C)** 
 100G, 220G, 338G, 511G \$928/kit
 673G \$974/kit **(L4)**
 Kit consists of: 1 pair Rallye Bucket Seat Covers, 1 set Rallye Seat Foam (4 pc.), 1 pair Stretch Panel Boards, 1 yd. Muslin, 30 ft. Listing Wire, 2 yd. Burlap, 9 ft. 2 inch Felt and 1 Dust Mask.
 Headrest Covers **HC66GA00N14(C)**
 (All Colors) \$82/pr.

This Legendary product features as-original heat sealed Madrid grain inserts and Madrid grain skirts with double beaded welt and accent bands.
NOTE: Customer must reuse original metal medallions. Medallions are available. See following section of catalog.

1967 CHEVELLE/MALIBU & EL CAMINO "OEM STYLE"

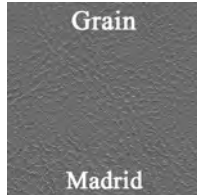

(C) COLOR CODES:
 (100G) Black
 (325G) Medium Blue - Chevelle Only
 (338G) Bright Blue - Chevelle Only
 (424G) Metallic Turquoise - Chevelle Only
 (501G) Red
 (651G) Gold

Front Buckets **AA67GHE0010(C)**
 100G, 325G, 338G, 501G \$501/pr.
 424G, 651G \$526/pr. **(L4)**
 Kit consists of: 1 pair Rallye Bucket Seat Covers, 1 set Rallye Seat Foam (4 pc.), 1 pair Stretch Panel Boards, 1 yd. Muslin, 30 ft. Listing Wire, 2 yd. Burlap, 9 ft. 2 inch Felt and 1 Dust Mask.
 Please see "GM Molded Foam" section in this catalog.
 Hardtop Rear **AA67GH00048(C)**
 100G, 325G, 338G, 501G \$323/ea.
 424G, 651G \$339/ea. **(L4)**
 Convertible Rear **AA67GH00056(C)**
 100G, 325G, 338G, 501G \$323/ea.
 424G, 651G \$339/ea. **(L4)**
 Headrest Covers **HC66GA00N14(C)**
 100G, 325G, 338G, 501G \$82/pr.
 424G, 651G \$86/pr. **(L4)**

This Legendary product features as-original Madrid grain inserts and Madrid grain skirts.
NOTE: Customer must reuse original metal medallions. Medallions are available. See following section of catalog.

1967 CHEVELLE/MALIBU & EL CAMINO RALLYE SEAT

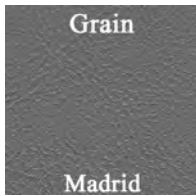

(C) COLOR CODES:
 (100G) Black
 (325G) Medium Blue - Chevelle Only
 (338G) Bright Blue - Chevelle Only
 (424G) Metallic Turquoise - Chevelle Only
 (501G) Red
 (651G) Gold

Front Buckets **RS67GHE0010(C)** 
 100G, 325G, 338G, 501G \$928/kit
 424G, 651G \$974/kit **(L4)**
 Kit consists of: 1 pair Rallye Bucket Seat Covers, 1 set Rallye Seat Foam (4 pc.), 1 pair Stretch Panel Boards, 1 yd. Muslin, 30 ft. Listing Wire, 2 yd. Burlap, 9 ft. 2 inch Felt and 1 Dust Mask.
 Headrest Covers **HC66GA00N14(C)**
 100G, 325G, 338G, 501G \$82/pr.
 424G, 651G \$86/pr. **(L4)**

This Legendary product features as-original Madrid grain inserts and Madrid grain skirts.
NOTE: Customer must reuse original metal medallions. Medallions are available. See following section of catalog.

1968 CHEVELLE/MALIBU & EL CAMINO "OEM STYLE"

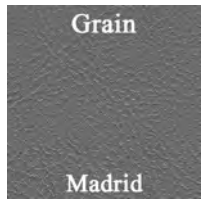

(C) COLOR CODES:

- (100G) Black
- (204G) Metallic Parchment - *Chevelle Only*
- (331G) Medium Blue
- (333G) Light Blue - *Chevelle Only*
- (501G) Red - *Chevelle Only*
- (654G) Saddle (*El Camino only*)
(Requires Sample Approval)
- (645G) Willow Gold - *Chevelle Only*

- Front Buckets **AA68GHE0010(C)**
100G, 204G, 331G, 501G ... \$526/pr.
- 333G, 645G \$552/pr. (L4)
- 654G \$1308/pr. (L1)

☞ Molded foam is available for this model.
Please see the "GM Molded Foam" section in this catalog.

- Hardtop Rear **AA68GH00047(C)**
100G, 204G, 331G, 501G ... \$323/ea.
- 333G, 645G \$339/ea. (L4)
- ☞ 679G Saddle was not available for El Camino.

- Convertible Rear **AA68GH00056(C)**
100G, 204G, 331G, 501G ... \$323/ea.
- 333G, 645G \$339/ea. (L4)
- ☞ 679G Saddle was not available for El Camino.

This Legendary product features as-original Madrid grain inserts and Madrid grain skirts with buttons.

1968 CHEVELLE/MALIBU & EL CAMINO RALLYE SEAT

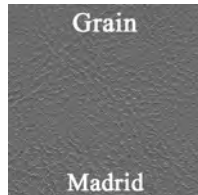

(C) COLOR CODES:

- (100G) Black
- (204G) Metallic Parchment - *Chevelle Only*
- (331G) Medium Blue
- (333G) Light Blue - *Chevelle Only*
- (501G) Red - *Chevelle Only*
- (645G) Willow Gold - *Chevelle Only*
- (654G) NOS Saddle - *El Camino Only*
- *Requires sample approval

- Front Buckets **RS68GHE0010(C)**
- 100G, 204G, 331G, 501G ... \$944/kit
- 333G, 645G \$991/kit (L4)
- 654G \$944/kit (L1)

☞ Kit consists of: 1 pair Rallye Bucket Seat Covers, 1 set Rallye Seat Foam (4 pc.), 1 pair Stretch Panel Boards, 1 yd. Muslin, 30 ft. Listing Wire, 2 yd. Burlap, 9 ft. 2 inch Felt and 1 Dust Mask.

This Legendary product features as-original Madrid grain inserts and Madrid grain skirts with buttons.

**1968 CHEVELLE/MALIBU "OEM STYLE"
"BUICK REPLACEMENT"**

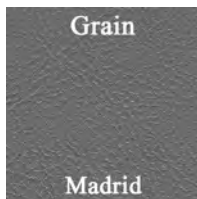

(C) COLOR CODES:
(100G) Black

- Front Buckets **AA68GKD0010(C)**
..... \$574/pr.
- ☞ Molded foam is available for this model.
- Hardtop Rear **AA68GKD0048(C)**
..... \$357/ea.

This Legendary product features as-original Heat sealed Madrid grain inserts w/ exact stitch pattern and Madrid grain skirts.
NOTE: Customer Must Reuse Original Metal Buttons



ACCORDING TO RIDLEY... BELIEVE IT!!

Original LEGENDARY Tech-Topics



**1968 CHEVELLE/MALIBU RALLYE SEAT
"BUICK REPLACEMENT"**

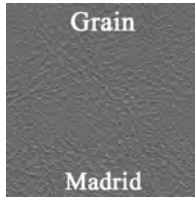

(C) COLOR CODES:
(100G) Black

Front Buckets**RS68GKD0010(C)** 
.....\$1002/kit
Ⓢ Kit consists of: 1 pair Rallye Bucket Seat Covers, 1 set Rallye Seat Foam (4 pc.), 1 pair Stretch Panel Boards, 1 yd. Muslin, 30 ft. Listing Wire, 2 yd. Burlap, 9 ft. 2 inch Felt and 1 Dust Mask.

This Legendary product features as-original Heat sealed Madrid grain inserts w/ exact stitch pattern and Madrid skirts.
NOTE: Customer Must Reuse Original Metal Buttons

**ACCORDING TO
RIDLEY...
BELIEVE IT!!**



**1968 CHEVELLE/MALIBU "OEM STYLE"
"OLDSMOBILE REPLACEMENT" [TRIM CODE 766-970]**

PHOTO N/A
AT TIME OF
PRINTING

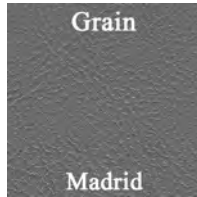

(C) COLOR CODES:
(100G) Black

Front Buckets**AA68GUD0010(C)**
(All Colors) \$645/pr.
Ⓢ Molded foam is available for this model.
Please see the "GM Molded Foam" section in this catalog.

**1968 CHEVELLE/MALIBU RALLYE SEAT
"OLDSMOBILE REPLACEMENT" [TRIM CODE 766-970]**

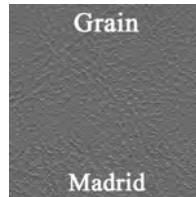

(C) COLOR CODES:
(100G) Black

Front Buckets**RS68GUD0010(C)** 
(All Colors) \$1068/kit
Ⓢ Kit consists of: 1 pair Rallye Bucket Seat Covers, 1 set Rallye Seat Foam (4 pc.), 1 pair Stretch Panel Boards, 1 yd. Muslin, 30 ft. Listing Wire, 2 yd. Burlap, 9 ft. 2 inch Felt and 1 Dust Mask.

This Legendary product features as-original Madrid grain inserts and Madrid grain skirts with buttons.

1968 EL CAMINO "OEM STYLE"
"PONTIAC REPLACEMENT" [TRIM CODE 766-223]

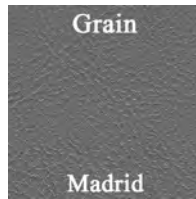

(C) COLOR CODES:
 (100G) Black

Front Buckets**AA68GG00010(C)**
 (All Colors) \$539/pr.
 ☞ Molded foam is available for this model.
 Please see the "GM Molded Foam" section in
 this catalog.

*This Legendary product features as-original Madrid grain inserts
 and Madrid grain skirts.*

1968 EL CAMINO RALLYE SEAT
"PONTIAC REPLACEMENT" [TRIM CODE 766-223]



Front Buckets**RS68GG00010(C)** 
 (All Colors) \$958/kit
 ☞ Kit consists of: 1 pair Rallye Bucket Seat Covers,
 1 set Rallye Seat Foam (4 pc.), 1 pair Stretch
 Panel Boards, 1 yd. Muslin, 30 ft. Listing Wire, 2
 yd. Burlap, 9 ft. 2 inch Felt and 1 Dust Mask.

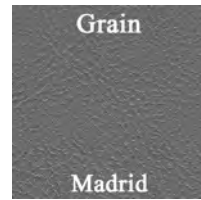

(C) COLOR CODES:
 (100G) Black

*This Legendary product features as-original Madrid grain inserts
 and Madrid grain skirts.*

1969 CHEVELLE/MALIBU & EL CAMINO "OEM STYLE"



(C) COLOR CODES:
 (100G) Black
 (239G) Metallic Parchment - Chevelle Only
 (369G) Metallic Blue
 (432G) Light Metallic Green - Chevelle Only
 (469G) Dark Metallic Green - Chevelle Only
 (511G) Red - Chevelle Only
 (654G) Saddle (El Camino only)
 (Requires Sample Approval)

Front Buckets**AA69GHE0010(C)**
 (All Colors) \$539/pr.
 654G \$1308/pr. (L1)
 ☞ Molded foam is available for this model.
 Please see the "GM Molded Foam" section in
 this catalog.

Hardtop Rear**AA69GH00047(C)**
 (All Colors) \$323/ea.

Convertible Rear**AA69GH00056(C)**
 (All Colors) \$323/ea.
 ☞ 432G Light Green, 469G Dark Green were not
 available in convertible models.

Headrest Covers**HC69GA00014(C)**
 100G, 239G, 369G,
 432G, 469G, 511G \$82/pr.
 654G \$1661/pr. (L1)
 ☞ Non-original replacement covers for factory
 molded headrests.
 ☞ Professional installation is recommended.

*This Legendary product features as-original deep channeled Heat sealed
 pinch pleated Madrid grain and Basketweave grain inserts. Featuring
 raised "puffed" pleating and Madrid grain skirts. Buttons are included.*



1969 CHEVELLE/MALIBU & EL CAMINO RALLYE SEAT



NEW!!!

Front Buckets **RS69GHE0010(C)** 
 (All Colors)\$956/kit
 ⚙️ Kit consists of: 1 pair Rallye Bucket Seat Covers, 1 set Rallye Seat Foam (4 pc.), 1 pair Stretch Panel Boards, 1 yd. Muslin, 30 ft. Listing Wire, 2 yd. Burlap, 9 ft. 2 inch Felt and 1 Dust Mask.

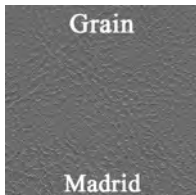

(C) COLOR CODES:

- (100G) Black
- (239G) Metallic Parchment - Chevelle Only
- (369G) Metallic Blue
- (432G) Light Metallic Green - Chevelle Only
- (469G) Dark Metallic Green - Chevelle Only
- (511G) Red - Chevelle Only
- (654G) Saddle (El Camino only)
 (Requires Sample Approval)

This Legendary product features as-original deep channeled Heat sealed pinch pleated Madrid grain and Basketweave grain inserts. Featuring raised "puffed" pleating and Madrid grain skirts. Buttons are included.

1970 CHEVELLE/MALIBU & EL CAMINO "OEM STYLE"

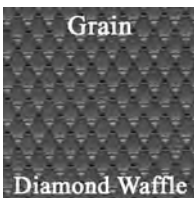
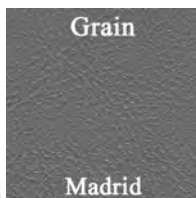

(C) COLOR CODES:

- (100G) Black
- (202G) Pearl White - Chevelle Only
- (310G) Light Metallic Blue
- (460G) Metallic Green - Chevelle Only
- (513G) Red - Chevelle Only
- (683G) Saddle

Front Buckets **AA70GHE0010(C)**
 (All Colors) \$539/pr.
 ⚙️ Molded foam is available for this model. Please see the "GM Molded Foam" section in this catalog.

Hardtop Rear **AA70GH00048(C)**
 (All Colors) \$323/ea.
 ⚙️ 310G Light Metallic Blue was not available in hardtop models.

Convertible Rear **AA70GH00056(C)**
 (All Colors) \$323/ea.
 ⚙️ 460G Metallic Green was not available in convertible models.

Headrest Covers **HC69GA00014(C)**
 (All Colors) \$82/pr.
 ⚙️ Non-original replacement covers for factory molded headrests.
 ⚙️ Professional installation is recommended.

This Legendary product features as-original deep channeled Heat sealed pinch pleated Madrid grain and Diamond Waffle grain inserts. Featuring raised "puffed" pleating and Madrid grain skirts.

NOTE: Customer must reuse original metal medallions. Medallions are available. See following section of catalog.

1970 CHEVELLE/MALIBU & EL CAMINO RALLYE SEAT



NEW!!!

Front Buckets **RS70GHE0010(C)** 
 (All Colors)\$958/kit
 ⚙️ Kit consists of: 1 pair Rallye Bucket Seat Covers, 1 set Rallye Seat Foam (4 pc.), 1 pair Stretch Panel Boards, 1 yd. Muslin, 30 ft. Listing Wire, 2 yd. Burlap, 9 ft. 2 inch Felt and 1 Dust Mask.

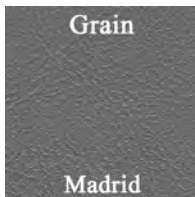

(C) COLOR CODES:

- (100G) Black
- (202G) Pearl White - Chevelle Only
- (310G) Light Metallic Blue
- (460G) Metallic Green - Chevelle Only
- (513G) Red - Chevelle Only
- (683G) Saddle

This Legendary product features as-original deep channeled Heat sealed pinch pleated Madrid grain and Diamond Waffle grain inserts. Featuring raised "puffed" pleating and Madrid grain skirts.

NOTE: Customer must reuse original metal medallions. Medallions are available. See following section of catalog.

1971 CHEVELLE/MALIBU/EL CAMINO & GMC SPRINT

"OEM STYLE"

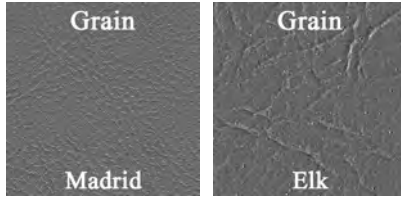

(C) COLOR CODES:

- (100G) Black
- (415G) Jade Green
- (690G) Saddle
- (697G) Sandalwood

This Legendary product features as-original Elk grain inserts and Madrid grain skirts.

Front Buckets **AA71GHE0010(C)**
 100G, 690G..... \$526/pr.
 415G, 697G..... \$552/pr. (L4)
 ☞ Molded foam is available for this model.
 Please see the "GM Molded Foam" section in this catalog.

Hardtop Rear **AA71GH00048(C)**
 100G, 690G..... \$323/ea.
 415G, 697G..... \$339/ea. (L4)

Convertible Rear..... **AA71GH00056(C)**
 100G, 690G..... \$323/ea.
 415G, 697G..... \$339/ea. (L4)
 ☞ 697G Sandalwood was not available in convertible models.

Headrest Covers..... **HC69GA00014(C)**
 (All Colors)..... \$82/pr.
 ☞ Non-original replacement covers for factory molded headrests.
 ☞ Professional installation is recommended.

1972 CHEVELLE/MALIBU/EL CAMINO & GMC SPRINT

"OEM STYLE"

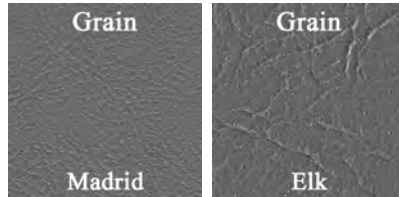

(C) COLOR CODES:

- (100G) Black
- (230G) White - Chevelle Only
- (465G) Green- Chevelle Only
- (670G) Tan
- (695G) Sandalwood

This Legendary product features as-original Elk grain inserts and Madrid grain skirts.

Front Buckets **AA71GHE0010(C)**
 100G, 230G..... \$526/pr.
 465G, 670G..... \$552/pr. (L4)
 695G..... \$1308/pr. (L1)
 ☞ Molded foam is available for this model. Please see the "GM Molded Foam" section in this catalog.

Hardtop Rear **AA72GH00048(C)**
 100G, 230G..... \$323/ea.
 465G, 670G..... \$339/ea. (L4)
 695G..... \$1187/pr. (L1)

Convertible Rear..... **AA72GH00056(C)**
 100G, 230G..... \$323/ea.
 465G..... \$339/ea. (L4)
 ☞ 670G Saddle and 695G Sandalwood were not available in convertible models.

Headrest Covers..... **HC69GA00014(C)**
 100G, 230G, 465G, 670G \$82/pr.
 695G..... \$161/pr. (L1)
 ☞ Non-original replacement covers for factory molded headrests.
 ☞ Professional installation is recommended.

1971-72 CHEVELLE/MALIBU/EL CAMINO & GMC SPRINT

RALLYE SEAT



NEW!!!

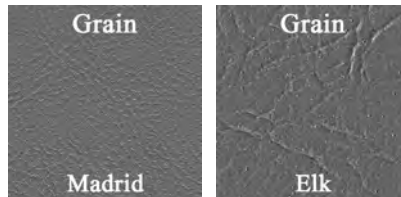

(C) COLOR CODES:

- (100G) Black
- (230G) White - Chevelle Only
- (415G) Jade Green
- (465G) Green- Chevelle Only
- (670G) Tan
- (690G) Saddle
- (697G) Sandalwood

This Legendary product features as-original Elk grain inserts and Madrid grain skirts.

Front Buckets **RS71GHE0010(C)** ^{OS2} _{OS3}
 100G, 230G, 690G \$944/kit
 415G, 465G, 670G, 697G \$991/kit (L4)
 ☞ Kit consists of: 1 pair Rallye Bucket Seat Covers, 1 set Rallye Seat Foam (4 pc.), 1 pair Stretch Panel Boards, 1 yd. Muslin, 30 ft. Listing Wire, 2 yd. Burlap, 9 ft. 2 inch Felt and 1 Dust Mask.



1964 CHEVELLE/MALIBU



Heat Sealed Emblem on Rear Center Panel

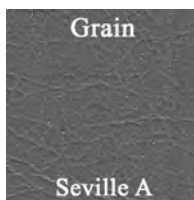

(C) COLOR CODES:

- (231G) Fawn
- (325G) Metallic Blue
- (419G) Light Met. Aqua
- (508G) Red
- (656G) Saddle

Front Split Bench	AA64GHE0020(C)
325G, 508G	\$551/pr.
231G, 419G	\$1346/pr. (L1)
656G	\$579/pr. (L4)
⚠ CURRENTLY NOT AVAILABLE. PLEASE CALL FOR DETAILS.	

Convertible Rear	AA64GH00056(C)
325G, 508G	\$323/ea.
231G, 419G	\$1140/ea. (L1)
656G	\$339/ea. (L4)

This Legendary product features as-original heat sealed Seville grain inserts and Seville grain skirts. Rear seat top center panel features heat sealed Chevrolet bowtie and emblem as-original.

1965 CHEVELLE/MALIBU



This Legendary product features as-original Madrid grain inserts and Madrid grain skirts.

(C) COLOR CODES:

- (322G) Dk. Met. Blue/Lt. Met. Blue - Chevelle Only
- (422G) Dk. Met. Aqua/NOS Lt. Met. Aqua
- (507G) Dk. Red/Red
- (638G) Gold/Fawn
- (639G) Gold/Fawn
- (686G) Met. Brown/Saddle - Chevelle Only

NOTE: Other color combinations will be available

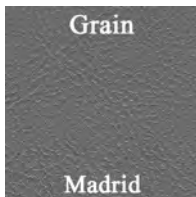

Front Split Bench	AA65GHE0020(C)
322G	\$501/pr.
422G, 639G	\$1021/pr. (L1)
686G	\$1308/pr. (L1)
507G, 638G	\$527/pr. (L4)
⚠ CURRENTLY NOT AVAILABLE. PLEASE CALL FOR DETAILS.	

Convertible Rear	AA65GH00056(C)
322G	\$323/ea.
507G, 638G	\$339/ea. (L4)
422G, 639G	\$1017/ea. (L1)
686G	\$1170/ea. (L1)

1966 CHEVELLE/MALIBU & EL CAMINO CLOTH STYLE



(C) COLOR CODES:

- (237G) Fawn Cloth/Fawn
- (373G) Dark Blue Cloth/Blue
- (483G) Dark Turquoise Cloth/Turquoise
- (552G) Red Cloth/Red

This Legendary product features as-original Renville Cloth inserts and Madrid grain skirts.

NOTE: Customer must reuse original metal medallions. Medallions are available. See following section of catalog.

Front Bench	AA66GHC0020(C)
237G, 373G, 483G, 552G	\$1151/pr. (L1)

Hardtop Rear	AA66GHC0080(C)
237G, 373G, 483G, 552G	\$901/ea. (L1)

Headrest Covers	HC66GA00014(C)
(All Colors)	\$82/pr.

Headrest Covers (Zippered)	HC66GA000214(C)
(All Colors)	\$102/pr.

⚠ Non-original replacement covers for factory molded headrests.
⚠ Professional installation is highly recommended.

1966 CHEVELLE/MALIBU & EL CAMINO

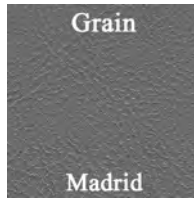

(C) COLOR CODES:

- (100G) Black - *Chevelle Only*
- (220G) Frost White - *Chevelle Only*
- (338G) Bright Blue - *Chevelle Only*
- (340G) Dark Metallic Blue / Lt Metallic Blue
- (484G) Dark Met Turq /NOS Lt Met Turq
- (511G) Red
- (526G) Bronze - *Chevelle Only*
- (673G) Fawn / Parchment

This Legendary product features as-original Madrid grain inserts and Madrid grain skirts.
 NOTE: Customer must reuse original metal medallions. Medallions are available. See following section of catalog.

Front Split Bench	AA66GHE0020(C)
100G, 220G, 338G, 340G, 511G...	\$501/pr.
673G	\$526/pr. (L4)
484G	\$1021/pr. (L1)
526G	\$1280/pr. (L1)
Hardtop Rear	AA66GH00048(C)
Convertible Rear	AA66GH00056(C)
100G, 220G, 338G, 340G, 511G...	\$323/ea.
673G	\$339/ea. (L4)
484G	\$1017/ea. (L1)
526G	\$1187/ea. (L1)
Headrest Covers	HC66GA00014(C)
100G, 220G, 235G, 325G, 338G, 511G, 526G	\$82/pr.
420G	\$161/pr. (L1)
Headrest Covers (Zippered)	HC66GA00Z14(C)
100G, 220G, 235G, 325G, 338G, 511G, 526G	\$102/pr.
420G	\$184/pr. (L1)
☞ Non-original replacement covers for factory molded headrests. ☞ Professional installation is highly recommended.	

1967 CHEVELLE/MALIBU & EL CAMINO

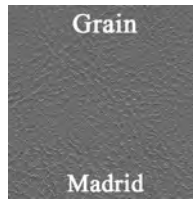

(C) COLOR CODES:

- (100G) Black
- (325G) Medium Blue
- (338G) Bright Blue - *Chevelle Only*
- (424G) Metallic Turquoise - *Chevelle Only*
- (501G) Red - *Chevelle Only*
- (651G) Gold

This Legendary product features as-original Madrid grain inserts and Madrid grain skirts.
 NOTE: Customer must reuse original metal medallions. Medallions are available. See following section of catalog.

Front Split Bench	AA67GHE0020(C)
100G, 325G, 338G, 501G...	\$501/ea.
424G, 651G	\$526/ea. (L4)
Hardtop Rear	AA67GH00048(C)
Convertible Rear	AA67GH00056(C)
100G, 325G, 338G, 501G	\$323/ea.
424G, 651G	\$339/ea. (L4)
Headrest Covers	HC66GA00014(C)
100G, 325G, 338G, 501G	\$82/pr.
424G, 651G	\$86/pr. (L4)
Headrest Covers (Zippered)	HC66GA00Z14(C)
100G, 325G, 338G, 501G	\$102/pr.
424G, 651G	\$107/pr. (L4)
☞ Non-original replacement covers for factory molded headrests. ☞ Professional installation is highly recommended.	

1968 CHEVELLE/MALIBU & EL CAMINO

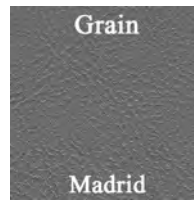

(C) COLOR CODES:

- (100G) Black
- (204G) Metallic Parchment - *Chevelle Only*
- (331G) Medium Blue (*El Camino only*)
- (333G) Light Blue - *Chevelle Only*
- (501G) Red - *Chevelle Only*
- (645G) Willow Gold - *Chevelle Only*
- (654G) Saddle (*El Camino only*)
(Requires Sample Approval)

This Legendary product features as-original Madrid grain inserts and Madrid grain skirts with buttons.

Front Split Bench	AA68GHE0020(C)
100G, 204G, 331G, 501G...	\$526/ea.
333G, 645G	\$552/ea. (L4)
654G	\$1308/ea. (L1)
Hardtop Rear	AA68GH00047(C)
Convertible Rear	AA68GH00056(C)
100G, 204G, 331G, 501G	\$323/ea.
333G, 645G	\$339/ea. (L4)
☞ 501G Red & 331G Light Metallic Blue were not available in hardtop models.	
☞ 204G Met. Parchment & 331G Light Met. Blue were not available in convertible models.	



1968 CHEVELLE/MALIBU

"BUICK REPLACEMENT" DELUXE BENCH STYLE [TRIM CODE 765-158]



Front Split Bench.....	AA68GKD0020(C)
.....	\$586/ea.
Hardtop Rear	AA68GKD0048(C)
.....	\$357/ea.
Convertible Rear.....	AA68GKD0056(C)
.....	\$357/ea.

(C) COLOR CODE:
(100G) Black

**ACCORDING TO
RIDLEY...
BELIEVE IT!!**



This Legendary product features as-original Heat sealed Madrid grain inserts w/ exact stitch pattern and Madrid grain skirts .
NOTE: Customer Must Reuse Original Metal Buttons

1968 CHEVELLE/MALIBU

"BUICK REPLACEMENT" STANDARD BENCH STYLE [TRIM CODE 765-118]

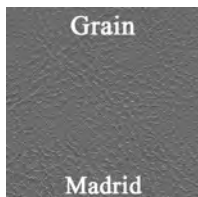

(C) COLOR CODE:
(100G) Black

Front Split Bench	AA68GKS0020(C)
(All Colors)	\$586/ea.
Hardtop Rear	AA68GKS0048(C)
(All Colors)	\$357/ea.

This Legendary product features as-original Heat sealed Madrid grain inserts w/ exact stitch pattern and Madrid grain skirts.
NOTE: Customer Must Reuse Original Metal Buttons

1968 CHEVELLE/MALIBU

"BUICK REPLACEMENT" DELUXE BENCH STYLE W/ CENTER ARM REST [TRIM CODE 765-168]

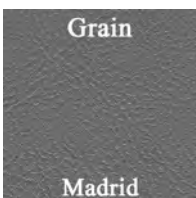

(C) COLOR CODE:
(100G) Black

Front Split Bench with Center Armrest	AA68GKD0030(C)
.....	\$586/ea.
Hardtop Rear	AA68GKD0048(C)
.....	\$357/ea.

This Legendary product features as-original Heat sealed Madrid grain inserts w/ exact stitch pattern and Madrid grain skirts.
NOTE: Customer Must Reuse Original Metal Buttons

The 1968 "Concours" option was standard on the Estate Wagon and was only available as a special order option (RPO ZJ6) on a Malibu Sport Sedan 4-door. In late March 1968 Chevrolet made the "Concours" option available as a special order (RPO ZK7) on the Chevelle/Malibu Sport Coupe 2-door models. All Chevelle/Malibu "Concours" 2-door models have "replacement" interiors in them properly noted on the firewall tag as '765-168' or '765-980'. '765' represents the Chevrolet split bench seat code while the '168' designates a Buick split bench seat with center armrest code and '980' designating an Oldsmobile split bench seat with a center armrest code. These Chevelle/Malibu Concours "replacement" interiors were all Front Split Bench seats with a Fold-Down Center Armrest. In fact the interiors that are found in these obscure Concours models are that of a 1968 Buick Skylark Custom (765-168 trim code) or a 1968 Oldsmobile Cutlass Supreme (765-980 trim code).
Total production: Chevelle/Malibu Concours Sport Coupe 2-door - 8,307 units.

1968 CHEVELLE/MALIBU

**"OLDSMOBILE REPLACEMENT" DELUXE BENCH STYLE W/ CENTER ARM REST
(TRIM CODE 765-980)**

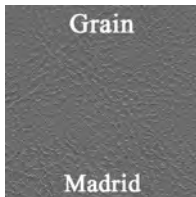

(C) COLOR CODE:
(100G) Black

Front Split Bench with Center Armrest
.....**AA68GUD0030(C)**
(All Colors).....\$671/ea.

Hardtop Rear**AA68GUD0048(C)**
(All Colors).....\$369/ea.

The 1968 "Concours" option was standard on the Estate Wagon and was only available as a special order option (RPO ZJ6) on a Malibu Sport Sedan 4-door. In late March 1968 Chevrolet made the "Concours" option available as a special order (RPO ZK7) on the Chevelle/Malibu Sport Coupe 2-door models. All Chevelle/Malibu "Concours" 2-door models have "replacement" interiors in them properly noted on the firewall tag as '765-168' or '765-980'. '765' represents the Chevrolet split bench seat code while the '168' designates a Buick split bench seat with center armrest code and '980' designating an Oldsmobile split bench seat with a center armrest code. These Chevelle/Malibu Concours "replacement" interiors were all Front Split Bench seats with a Fold-Down Center Armrest. In fact the interiors that are found in these obscure Concours models are that of a 1968 Buick Skylark Custom (765-168 trim code) or a 1968 Oldsmobile Cutlass Supreme (765-980 trim code). **Total production: Chevelle/Malibu Concours Sport Coupe 2-door - 8,307 units.**

This Legendary product features as-original Heat sealed Madrid grain inserts w/ exact stitch pattern and Madrid grain skirts.

**1969 CHEVELLE & MALIBU
CLOTH STYLE**

PHOTO N/A
AT TIME OF
PRINTING



(C) COLOR CODES:
(115G) Black Cloth/Black
(312G) Dark Blue Cloth/Dark Blue
(411G) Dark Green Cloth/Dark Green
(417G) Light Green Cloth/Light Green
(431G) Turquoise Cloth/Turquoise

Front Split Bench
.....**AA69GHC0020(C)**
115G, 312G, 411G, 417G...\$1151/ea. (L1)
431G.....\$1530/ea. (L1)

Hardtop Rear
.....**AA69GHC0080(C)**
115G, 312G, 411G, 417G.....\$901/ea. (L1)
431G.....\$1196/ea. (L1)

This Legendary product features as-original Rior Cloth inserts and Madrid Grain skirts and buttons.

1969 CHEVELLE/MALIBU/EL CAMINO

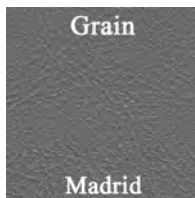

(C) COLOR CODES:
(100G) Black
(239G) Metallic Parchment - Chevelle Only
(369G) Metallic Blue
(432G) Light Metallic Green - Chevelle Only
(469G) Dark Green - Chevelle Only
(511G) Red - Chevelle Only
(654G) Saddle (El Camino only)
(Requires Sample Approval)

Front Split Bench
.....**AA69GHE0020(C)**
100G, 239G, 369G,
432G, 469G, 511G.....\$539/ea.
654G.....\$1308/ea. (L1)

Hardtop Rear**AA69GH00047(C)**
(All Colors).....\$323/ea.
☞ 369G Metallic Blue and 679G Saddle were
not available in hardtop models.

Convertible Rear....**AA69GH00056(C)**
(All Colors).....\$323/ea.
☞ 432G Light Metallic Green, 469G Dark
Green and 679G Saddle were not available in
convertible models.

Headrest Covers....**HC69GA00N14(C)**
100G, 239G, 369G,
432G, 469G, 511G\$82/pr.
654G.....\$161/pr. (L1)

This Legendary product features as-original deep channeled Heat sealed pinch pleated Madrid grain and Basketweave grain inserts. Featuring raised "puffed" pleating and Madrid grain skirts. Buttons are included.



Seat Upholstery Installation Kits Are Available To Help Complete Your Install!!

Seat upholstery Installation Kits from Legendary give you the products you need to do the job yourself!! All components are upholstery grade and have been hand selected by our team of installation experts to provide the highest quality materials available.



Check Out the Installation Kits Section For More Information

***Right After Seat Upholstery Section**

1970 CHEVELLE/MALIBU/EL CAMINO

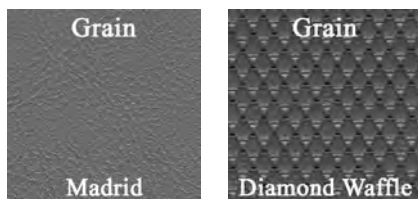

- (C) COLOR CODES:**
 (100G) Black
 (202G) Pearl White - Chevelle Only
 (310G) Light Metallic Blue
 (460G) Metallic Green - Chevelle Only
 (513G) Red - Chevelle Only
 (683G) Saddle

This Legendary product features as-original deep channeled Heat sealed pinch pleated Madrid grain and Diamond Waffle grain inserts. Featuring raised "puffed" pleating and Madrid grain skirts.

NOTE: Customer must reuse original metal medallions. Medallions are available. See following section of catalog.

Front Split Bench **AA70GHE0020(C)**
 (All Colors) \$539/ea.

Hardtop Rear **AA70GH00048(C)**
 (All Colors) \$323/ea.
 ☞ 310G Light Metallic Blue was not available in hardtop models.

Convertible Rear **AA70GH00056(C)**
 (All Colors) \$323/ea.
 ☞ 460G Metallic Green was not available in convertible models.

Headrest Covers..... **HC70GA00014(C)**
 (All Colors).....\$82/pr.

1971 CHEVELLE/MALIBU/EL CAMINO & GMC SPRINT

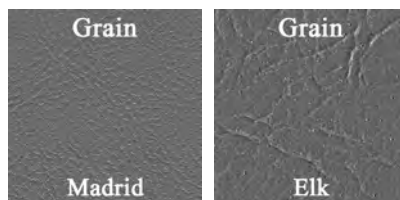

- (C) COLOR CODES:**
 (100G) Black
 (415G) Jade Green
 (690G) Saddle
 (697G) Sandalwood

This Legendary product features as-original Elk grain inserts and Madrid grain skirts.

Front Split Bench..... **AA71GHE0020(C)**
 100G, 690G\$526/ea.
 415G, 697G\$552/ea. (L4)
 ☞ 697G Sandalwood was not available in convertible models.

Hardtop Rear **AA71GH00048(C)**
 100G, 690G \$323/ea.
 415G, 697G \$339/ea. (L4)

Convertible Rear **AA71GH00056(C)**
 100G, 690G \$323/ea.
 415G \$339/ea. (L4)
 ☞ 697G Sandalwood was not available in convertible models.

Headrest Covers..... **HC70GA00014(C)**
 100G, 690G \$82/pr.
 415G, 697G \$86/pr. (L4)

**1971 CHEVELLE/MALIBU/EL CAMINO & GMC SPRINT
CLOTH STYLE**

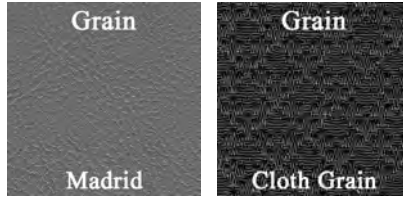

(C) COLOR CODES:
 (108G) Black Cloth/Black
 (328G) Blue Cloth/Blue
 (408G) Jade Green Cloth/Jade Green
 (681G) Sandalwood Cloth/Sandalwood

Front Split Bench	AA71GHC0020(C)
(All Colors)	\$1044/ea. (L2)
Hardtop Rear	AA71GHC0080(C)
(All Colors)	\$819/ea. (L2)
Headrest Covers	HC70GA00014(C)
100G, 380G	\$82/pr.
415G, 697G	\$86/pr. (L4)

This Legendary product features as-original Rondel cloth inserts and Madrid grain skirts.

1972 CHEVELLE/MALIBU/EL CAMINO & GMC SPRINT

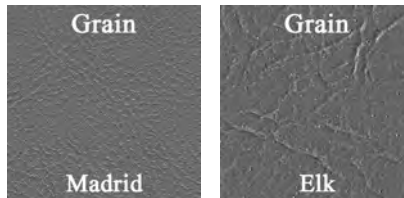

(C) COLOR CODES:
 (100G) Black
 (230G) White - Chevelle Only
 (465G) Green - Chevelle Only
 (670G) Tan
 (695G) Sandalwood

This Legendary product features as-original Elk grain inserts and Madrid grain skirts.

Front Split Bench	AA71GHE0020(C)
100G, 230G	\$526/ea.
465G, 670G	\$552/ea. (L4)
695G	\$1280/ea.
<i>670G Saddle and 695G Sandalwood were not available in convertible models.</i>	
Hardtop Rear	AA72GH00048(C)
100G, 230G	\$323/ea.
465G, 670G	\$339/ea. (L4)
695G	\$1187/ea.
Convertible Rear	AA72GH00056(C)
100G, 230G	\$323/ea.
465G	\$339/ea. (L4)
<i>670G Saddle and 695G Sandalwood were not available in convertible models.</i>	
Headrest Covers	HC70GA00014(C)
100G, 230G	\$82/pr.
695G	\$161/pr.
465G, 670G	\$86/pr. (L4)

**1972 CHEVELLE/MALIBU/EL CAMINO & GMC SPRINT
CLOTH STYLE**

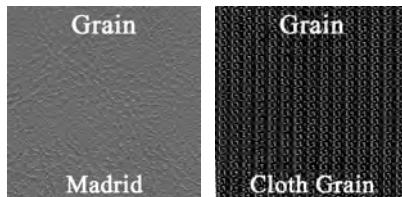

(C) COLOR CODES:
 (109G) Black Cloth/Black
 (324G) Blue Cloth/Blue
 (682G) Sandalwood Cloth/Sandalwood

Front Split Bench	AA72GHC0020(C)
109G	\$1040/ea.
324G, 682G	\$1044/ea. (L1)
Hardtop Rear	AA72GHC0080(C)
109G	\$819/ea.
324G, 682G	\$819/ea. (L1)
Headrest Covers	HC70GA00014(C)
(All Colors)	\$82/pr.
695G	\$161/pr (L1)

This Legendary product features as-original Rianon cloth grain inserts and Madrid grain skirts.



HOG RING PLIER KITS



Standard Hog Ring Plier Kit

TAHOG\$ 8.00/ea.
 ☞ Kit contains pliers and enough hog rings for a front or rear installation only.

Deluxe Hog Ring Plier Kit

TAHOGHVV (shown).....\$39.00/ea.
 ☞ Kit contains heavy duty pliers and enough hog rings for a complete front and rear installation.

Hog Rings (Pkg/200)

TAHOGRING200.....\$ 5.00/pk.

FOAM & COTTON ACCESSORIES

Cotton Batting (1 Roll)

TACOTTONROLL (952).....\$48.00/ea.
 ☞ 1 Roll consists of 10 lbs.
 ☞ Must be used in conjunction with Legendary muslin.

Muslin (1 yard)

TAYDMUSLIN.....\$ 3.00/yd.
 ☞ Must be used in conjunction with Legendary cotton batting.

High Density Foam

TAFOAM1 (1.5" thick x 12" x 12")\$20.00/ea.
TAFOAM2 (1.5" thick x 24" x 24")\$38.00/ea.
TAFOAM3 (1.5" thick x 30" x 70") (981).....\$82.00/ea.

Burlap (36" wide)

TABURLAP\$ 3.00/yd.

Paper Coated Wire

TAPAPERWIRE.....\$ 2.50/ft.

SEAT BOTTOM STRETCH PANEL BOARDS

Die-cut seat bottom stretch panel boards for 1965-72 bucket seats. These panel boards attach to the back-side of the bottom seat frame under the upholstery.



1965 Chevelle,El Camino

SK65GA-PANEL (Bucket seats only) ...\$27.00/pr.

1966-67 Chevelle,El Camino

SK66GA-BNHPANEL (Bench seats only)..\$37.00/ea.



1966-72 Chevelle,El Camino

SK66GA-PANEL (Bucket seats only)\$6.00/pr.

SEAT ADJUSTMENT KNOBS



TA64GA-KNOB

TA67GA-KNOB

TA71GA-KNOB

Reproduction seat knobs move the seat forward and back. These will work for both bucket and bench seats. For bucket seats use (2) knobs, for bench seats use (1) knob.

1964-65 Chevelle,El Camino

TA64GA-KNOB (Chrome).....\$29.00/ea.
 ☞ Will work for 1966 models but fit is slightly different.

1967-70 Chevelle,El Camino

TA67GA-KNOB (Chrome).....\$10.00/ea.
 ☞ Some 1970 models use black seat knobs. See part # TA70GA-KNOB.

1971-72 Chevelle,El Camino

TA71GA-KNOB (Black).....\$15.00/ea.

BENCH SEATBACK RELEASE KNOB



This seat release knob allows the seatback to fold forward on bench seat models.

1967-72 Chevelle,El Camino

TA67GA-BNHKNOB (Chrome).....\$10.00/ea.

1966-72 BUCKET SEATBACKS



Reproduction seatbacks are made of original-style heat-stamped plastic and feature the correct Madrid grain look. Each seatback has been manufactured to original specifications. Chrome beading included.

1966 Chevelle,El Camino

SK66GA01T (Black)..... discontinued
SK66GA(C)T (Colors)..... discontinued
 ☞ 1966 seatbacks were originally metal.

1968 Chevelle,El Camino

SK68GA01T (Black).....\$131.00/pr.
SK68GA(C)T (Colors).....\$131.00/pr.
 ☞ Please specify color at time of order.

1969-72 Chevelle,El Camino

SK69GA01T (Black).....\$131.00/pr.
SK69GA(C)T (Colors).....\$131.00/pr.
 ☞ Please specify color at time of order.

1966-72 BUCKET SEAT BASES



Reproduction lower seat bases are made of original-style heat-stamped plastic and feature the correct Madrid grain look. Chrome beading included. Please specify color at time of order.

☞ (1) pair = (1) seat, (2) pairs required for (2) seats.
 ☞ Please specify color at time of order.
 ☞ 1966-67 seat bases were originally metal.

1966-67 Chevelle,El Camino

SK66GA01B (Black)\$109.00/pr.
SK66GA(C)B (Colors).....\$109.00/pr.

1968 Chevelle,El Camino

SK68GA01B (Black)\$109.00/pr.
SK68GA(C)B (Colors).....\$109.00/pr.

1969-72 Chevelle,El Camino

SK69GA01B (Black)\$109.00/pr.
SK69GA(C)B (Colors).....\$109.00/pr.

1966 COLOR CODES (C)

- (01) Black
- (02) White
- (03) Red
- (04) Turquoise
- (10) Bright Blue
- (18) Light Blue

1967 COLOR CODES (C)

- (01) Black
- (02) White
- (03) Red
- (04) Turquoise
- (10) Bright Blue
- (18) Light Blue

1968 COLOR CODES (C)

- (01) Black
- (03) Red
- (11) Medium Blue
- (18) Light Blue
- (204) Metallic Parchment

1969-72 COLOR CODES (C)

- (01) Black
- (02) White
- (03) Red
- (07) Dark Blue
- (10) Bright Blue
- (13) Dark Green
- (27) Light Saddle
- (29) Dark Saddle
- (38) Sandalwood
- (202) Pearl White
- (235) Parchment
- (239) Metallic Parchment

1966-72 BUCKET SEAT CHROME TRIM & "BULLET" END CAPS



Chrome Trim

SK66GA-CHR\$32.00/set

"Bullet" End Caps

SK66GA-CAP (Set/12).....\$32.00/set

Chevrolet

BUCKET SEAT HEADRESTS

Reproduction bucket seat headrests made of molded urethane. Available in black only.



1966-67 Chevelle, El Camino
HR66GA01\$285.00/pr.

1969 Chevelle, El Camino
HR69GA01\$252.00/pr.

1970-72 Chevelle, El Camino
HR70GA01\$252.00/pr.

BUCKET SEAT HEADRESTS BASE TRIM

Plastic base trim piece slides onto the headrest post and mounts to the underside of the headrest



HR68GA-BNH

1968-72 Chevelle & El Camino
Bench Seat Style

HR68GA-BNH01 (black)\$26.00/pr.

HR68GA-BNH02 (white)\$26.00/pr.

☞ Plastic fasteners NOT INCLUDED

☞ Available in black or white. For colors other than black or white, customer must paint to match their interior color.



HR68GA-BKT

1968-72 Chevelle & El Camino
Bucket Seat Style

HR68GA-BKT01 (black)\$23.00/pr.

HR68GA-BKT02 (white)\$23.00/pr.

☞ Plastic fasteners NOT INCLUDED

☞ Available in black or white. For colors other than black or white, customer must paint to match their interior color.

SEATBACK BUMPERS



BU64GA-BKKIT

BU66GA-BKKIT

Rubber bumpers for 1964-1972 bucket seat models. These bumpers keep the front seat tops in the correct upright position and mount on the backside of the front seat bottoms.

1964-65 Chevelle, El Camino

BU64GA-BKKIT (screws included)..... \$11.00/pr.

☞ These bumpers will also fit most 1964-72 Tempest, LeMans & GTO bench seats.

1966-72 Chevelle, El Camino

BU66GA-BKKIT (screws included)..... \$10.00/pr.

BUCKET SEAT SPRING ASSEMBLY

Reproduction seat assemblies for 1964-72 Chevelle & El Camino replace fatigued or broken springs and restore the comfort and support of the originals. Avoid the mistake of restoring your bucket seats without new, properly tensioned seat springs.

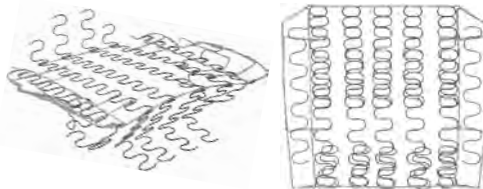

1964-65 Seat bottom (SA64GA-B) 1964-65 Seatback (SA64GA-T)

1964-65 Chevelle, El Camino

SA64GA-T (Seatback) (Shown)\$159.00/ea.

SA64GA-B (Seat bottom) (Shown).....\$175.00/ea.

1966-67 Chevelle, El Camino

SA66GH-T (Seatback)\$175.00/ea.

SA66GA-B (Seat bottom)\$175.00/ea.

1968-72 Chevelle, El Camino

SA68GA-T (1968 Seatback)\$175.00/ea.

SA69GA-T (1969-72 Seatback)\$159.00/ea.

SA68GA-B (Seat bottom).....\$159.00/ea.

SEAT COVER MEDALLIONS

Finish off your seat upholstery restoration with exact reproduction seat cover medallions and mounting plates.



1966 Chevelle, Malibu & El Camino

AA66GHE-EMBLEM (Shown)\$54.00/pr.

1967 Chevelle, Malibu & El Camino

AA67GHE-EMBLEM\$87.00/set

☞ Set includes 4 emblems.



1970 Chevelle, Malibu & El Camino

AA70GHE-EMBLEM2\$43.00/pr.

☞ Includes 2 emblems for front or rear upholstery

AA70GHE-EMBLEM4 (Shown)\$65.00/set

☞ Includes 4 emblems for front and rear upholstery

1966-67 BUCKET SEAT HEADREST MOUNTING KIT



1966-67 Chevelle, El Camino

HR66GA-BRACKET\$120.00/pr.

BUCKET SEAT MOUNT CONVERSION BRACKETS



Die-stamped steel brackets allow you to mount bucket seats in 1966-72 models originally equipped with a bench seat.

TA66GA-BRACKET\$39.00/set

☞ (1) set does (2) bucket seat. These brackets are to be welded near the transmission tunnel side so your inside bucket seat tracks can be mounted.

1964-65 BUCKET SEAT CHROME HINGE ROD END CAP



Chrome plated reproduction of the original end caps.

SK64GA-CAP\$5.00/ea.

1969-72 BUCKET HEADREST LOCK ASSEMBLY

Authentic reproduction chrome plated bucket seat headrest locks include the escutcheon and lock as part of the lock assembly. These mount to the bucket front seat tops where the headrest posts slide into the seat.



1969 Chevelle, El Camino

HR69GA-COVER\$65.00/pr.

1970-72 Chevelle, El Camino

HR70GA-COVER (shown)\$54.00/pr.

BUCKET SEATBACK RELEASE BUTTONS

These seat release buttons allow the seatback to fold forward on bucket seat models.



TA67GA-BUTTON

TA69GA-BUTTON

1967-68 Chevelle, El Camino

SK67GA-BUTTON\$54.00/ea.



1969-72 Chevelle, El Camino



SK69GA-BUTTON\$43.00/ea.





MOLDED FOAM AND FOAM ACCESORIES

 facebook.com/legendaryautointeriors
 twitter.com/legendaryautoin

 www.legendaryautointeriors.com
 instagram.com/legendaryautointeriorsltd
 youtube.com/user/legendaryauto

ORIGINAL REPRODUCTION SEAT FOAM

Don't put new seat covers over old deteriorated foam cushions! With these foam kits you will enjoy the appearance and comfort of factory new again in your Chevelle and El Camino. These foam kits feature an exclusive cold cure molding process and a limited lifetime guarantee.



1964-65 BUCKET SEAT FOAM

Molded foam for 1964-65 Chevelle, Malibu and El Camino models with bucket seats. Sets consist of a pair of (2) front seat tops and (2) front seat bottoms.



MF62GA\$369.00/set
 ☞ Professional installation is highly recommended. Please see our installation services page.

1966-70 BUCKET SEAT FOAM

Molded foam for 1966-70 Chevelle, Malibu and El Camino models with bucket seats. Sets consist of a pair of (2) front seat tops and (2) front seat bottoms.



MF66GA\$369.00/set
 ☞ Professional installation is highly recommended. Please see our installation services page.

1971-72 BUCKET SEAT FOAM

Molded foam for 1971-72 Chevelle, Malibu and El Camino models with bucket seats. Sets consist of a pair of (2) front seat tops and (2) front seat bottoms.



MF71GA\$369.00/set
 ☞ Professional installation is highly recommended. Please see our installation services page.

1966-70 BENCH SEAT FOAM

Molded foam for 1966-70 Chevelle, Malibu and El Camino models with bench seats. Sets consist of (1) front seat top and (1) front seat bottom.



MF66GA-BENCH\$399.00/set
 ☞ Professional installation is highly recommended. Please see our installation services page.

1971-72 BENCH SEAT FOAM

Molded foam for 1971-72 Chevelle, Malibu and El Camino models with bench seats. Sets consist of (1) front seat top and (1) front seat bottom.



MF71GA-BENCH\$509.00/set
 ☞ Professional installation is highly recommended. Please see our installation services page.



Seat Upholstery Installation Kits NOW AVAILABLE!!!

Seat upholstery Installation Kits from **Legendary** give you the products you need to do the job yourself!! All components are upholstery grade and have been hand selected by our team of installation experts to provide the highest quality materials available.



HARDTOP AND CONVERTIBLE REAR SEATS

All 1964-72 General Motors A-Body



INSTALLATION-KIT2.....\$279.00/ea.
 Kit includes: (1) 30"x70" 1 1/2" thick foam, (1) 10lb. roll of cotton, 4 yards of burlap, 12 feet of paper coated listing wire, 2 yards of muslin, (1) 3 1/2" x 64" Wire Edge Reinforced Burlap Cotton Support Band & a dust mask.

SPLIT BENCH & FULL BENCH FRONT SEATS

All 1964-72 General Motors A-Body
 *With & Without Center Armrest



INSTALLATION-KIT4.....\$279.00/ea.
 Kit includes: (1) 30"x70" 1 1/2" thick foam, (1) 10lb. roll of cotton, 4 yards of burlap, 12 feet of paper coated listing wire, 2 yards of muslin, 3 yards of 2 inch wide felt, (1) 3 1/2" x 64" Wire Edge Reinforced Burlap Cotton Support Band & a dust mask.

SEAT INSTALLATION KITS

BUCKET FRONT SEATS



Kit 10 - 1964-65

INSTALLATION-KIT10.....\$89.00/ea.
 Kit includes: (1) 5lb. roll of cotton, 2 yards of burlap, 45 feet of paper coated listing wire, 3 yards of 2 inch wide felt, (1) 3 1/2" x 64" Wire Edge Reinforced Burlap Cotton Support Band a dust mask & Side Hinge Felt.

BUCKET FRONT SEATS

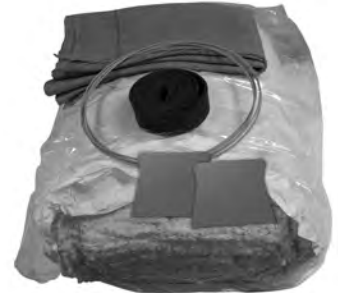

Kit 3 - 1966-72

INSTALLATION-KIT3.....\$69.00/ea.
 Kit includes: (1) 5lb. roll of cotton, 3 yards of burlap, 45 feet of paper coated listing wire, 3 yards of 2 inch wide felt, (2) stretch panel boards & a dust mask.

INSTALLATION SERVICES

GM, CHRYSLER & AMC SEAT UPHOLSTERY

(Includes tear down of original upholstery and installation of new upholstery)



Front Buckets Install - \$500.00/pr.
(No Headrest Covers)



Front Buckets w/ Headrest Covers Install - \$600.00/pr.



Front Split Bench Install - \$575.00/ea.



Front Split Bench w/ Headrest Covers Install - \$675.00/ea.



Rear Bench Seat Install - \$400.00/ea.



Headrest Covers Install - \$150.00/pr.

Center Armrest Install - \$150.00/ea.
(for models w/ buckets and no console)



SAVE ON COMPLETE FRONT & REAR INSTALLS!!

Front Buckets & Rear Bench Seat Install - \$750.00/set

Front Buckets w/ Headrest Covers & Rear Bench Seat Install - \$850.00/set

Front Split Bench & Rear Bench Seat Install - \$825.00/set



Front Split Bench w/ Headrest Covers & Rear Bench Seat Install - \$925.00/set



NOTE* Basic installations DO NOT include new foam and cotton replacement or reconstruction, media blasting, painting, welding, frame straightening, polishing or trim detailing. These services are additional and available at an hourly rate. Please call for more details. **1-800-363-8804*





DOOR PANEL AND TRIM ACCESORIES

 facebook.com/legendaryautointeriors
 twitter.com/legendaryautoin

 www.legendaryautointeriors.com
 instagram.com/legendaryautointeriorsltd
 youtube.com/user/legendaryauto

1964 CHEVELLE/MALIBU

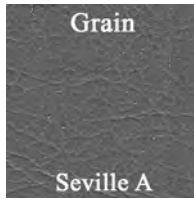

(C) COLOR CODES:

- (100G) Black
- (220G) Frost White
- (231G) Fawn
- (325G) Metallic Blue
- (419G) Light Aqua
- (508G) Red
- (656G) Saddle

Front Panels.....	DO64GH00012(C)
100G, 220G, 325G, 508G	\$408/pr.
231G, 419G	\$756/pr. (L1)
656G.....	\$428/pr. (L4)
Hardtop Rear Panels.....	DO64GH00048(C)
100G, 220G, 325G, 508G	\$200/pr.
231G, 419G	\$387/pr. (L1)
656G.....	\$210/pr. (L4)
Convertible Rear Panels.....	DO64GH00056(C)
100G, 220G, 325G, 508G	\$200/pr.
231G, 419G	\$387/pr. (L1)
656G.....	\$210/pr. (L4)
Armrest/Well Covers (Convertible)	
.....	AW64GA00056(C)
100G, 220G, 231G, 325G, 508G.....	\$101.00/pr.
419G	\$225.00/pr. (L1)
656G	\$106.00/pr. (L4)

This Legendary product features as-original die-electrically heat sealed Seville grain vinyl. Front Panels also feature a heat sealed chrome Chevrolet bowtie emblem and correct profile chrome accent as-original. Special cutout area in filler board to accommodate armrest base. Multi-Level Construction 3-Dimensional Panel.

1964 EL CAMINO

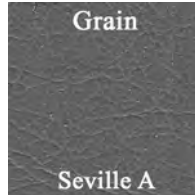

(C) COLOR CODES:

- (231G) Fawn
- (419G) Light Aqua
- (508G) Red

Front Panels.....	DO64GE00012(C)
231G, 419G.....	\$756/pr. (L1)
508G.....	\$408/pr.

This Legendary product features as-original die-electrically heat sealed Seville grain vinyl. Panels have special cutout area in filler board to accommodate armrest base. Multi-Level Construction 3-Dimensional Panel.

NOTE: Customer must reuse original decorative trim and medallions.

1965 CHEVELLE/MALIBU



(C) COLOR CODES:

- (100G) Black
- (140G) Slate (Convertible rear panels only)
- (141G) Slate w/ Charcoal Blue bottom
- (218G) Frost White w/ Aqua bottom
- (220G) Frost White (Convertible rear panels only)
- (221G) Frost White w/ Black bottom
- (232G) Fawn
- (235G) Fawn
- (322G) Met. Blue w/ Medium Blue bottom
- (325G) Met. Blue (Convertible rear panels only)
- (420G) NOS Lt. Met. Aqua
- (501G) Red
- (679G) Saddle

Front Panels.....	DO65GH00012(C)
100G, 221G, 235G, 322G, 325G, 501G.....	\$359/pr.
141G, 232G, 420G, 679G.....	\$756/pr. (L1)
218G.....	\$377/pr. (L4)
Hardtop Rear Panels.....	DO65GH00048(C)
100G, 221G, 235G, 322G, 501G..	\$200/pr.
141G, 232G, 679G.....	\$387/pr. (L1)
218G.....	\$210/pr. (L4)
Convertible Rear Panels..	DO65GH00056(C)
100G, 220G, 235G, 325G, 501G.....	\$200/pr.
140G, 232G, 420G, 679G.....	\$387/pr. (L1)
Armrest/Well Covers (Convertible)	
.....	AW65GA00056(C)
100G, 235G, 501G	\$96.00/pr.
232G, 420G, 679G	\$214.00/pr. (L1)
.....	AW65GH00056(C)
218G, 221G, 322G	\$101.00/pr.
141G.....	\$225.00/pr. (L1)
218G.....	\$106.00/pr. (L4)

This Legendary product features as-original die-electrically heat sealed Madrid grain vinyl. Panels have special cutout area in filler board to accommodate armrest base. Multi-Level Construction 3-Dimensional Panel.

NOTE: Customer must reuse original decorative trim and medallions.



1965 EL CAMINO

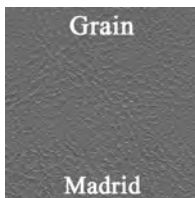

(C) COLOR CODES:
 (232G) Fawn
 (235G) Fawn
 (420G) NOS Light Aqua
 (501G) Red

Front Panels	DO65GE00012(C)
232G, 420G	\$756/pr. (L1)
235G, 511G	\$359/pr.

This Legendary product features as-original die-electrically heat sealed Madrid grain vinyl. Panels have special cutout area in filler board to accommodate armrest base. Multi-Level Construction 3-Dimensional Panel.

NOTE: Customer must reuse original decorative trim and medallions.

1966 CHEVELLE/MALIBU & EL CAMINO

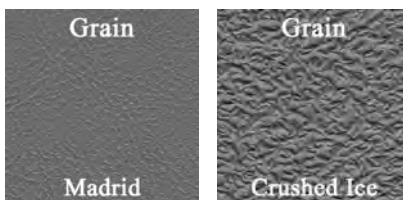

(C) COLOR CODES:
 (100G) Black
 (220G) White (Convertible rear panels only)
 (221G) Frost White w/ Black bottom
 (235G) Parchment (Convertible rear panels only)
 (325G) Light Blue (Convertible rear panels only)
 (338G) Bright Blue (Convertible rear panels only)
 (340G) Light Blue w/ Medium Blue bottom (Bench interiors only)
 (341G) Bright Blue w/ Medium Blue bottom
 (420G) NOS Light Turquoise (Convertible rear panels only)
 (484G) NOS Light Turq. w/ Dark Turq. bottom (Bench interiors only)
 (511G) Red
 (526G) Bronze
 (673G) Parchment w/ Fawn bottom (See footnote)
 (674G) Parchment w/ Dark Fawn bottom (See footnote)

El Camino Front Panels.....	DO66GE00012(C)
100G, 340G, 511G	\$408/pr.
674G.....	\$578/pr. (L1)
673G.....	\$428/pr. (L4)
Chevelle Front Panels	DO66GH00012(C)
100G, 221G, 340G, 341G, 511G....	\$408/pr.
484G, 674G	\$578/pr. (L1)
526G.....	\$756/pr. (L1)
673G.....	\$428/pr. (L4)
Chevelle Htp Rear Panels	DO66GH00048(C)
100G, 221G, 340G, 341G, 501G....	\$200/pr.
484G, 674G	\$291/pr. (L1)
526G.....	\$387/pr. (L1)
673G.....	\$210/pr. (L4)
Chevelle Conv Rear Panels ...	DO66GH00056(C)
100G, 220G, 235G, 325G,	
338G, 511G	\$200/pr.
420G, 526G	\$387/pr. (L1)
Armrest/Well Covers (Conv)	
.....	AW66GA00056(C)
100G, 511G,	\$101.00/pr.
526G.....	\$225.00/pr. (L1)
.....	AW66GH00056(C)
221G, 340G, 341G, 673G	\$101.00/pr.
484G, 674G	\$225.00/pr. (L1)
673G.....	\$106.00/pr. (L4)

This Legendary product features as-original die-electrically heat sealed Madrid grain vinyl with fine pebble grain chrome accent & Crushed Ice grain lower section. Special cutout area in filler board to accommodate armrest base. Multi-Level Construction 3-Dimensional Panel. NOTE: Customer must reuse original medallions or purchase our reproduction door panel medallions at additional cost. See following section of catalog. NOTE: 674G Parchment/NOS Dark Fawn colors are correct for models with the 673G Parchment/Fawn upholstery color scheme. 673G is offered in door panels as an option for customers looking to match the upholstery, but is not correct for concours cars.

1967 CHEVELLE/MALIBU & EL CAMINO



(C) COLOR CODES:
 (100G) Black (325G) Medium Blue
 (338G) Bright Blue (424G) Metallic Turquoise
 (501G) Red (651G) Gold

Front Panels	DO67GH00012(C)
100G, 325G, 338G, 501G ...	\$359/pr.
424G, 651G.....	\$377.00/pr. (L4)
Hardtop Rear Panels	
.....	DO67GH00048(C)
100G, 325G, 338G, 501G ...	\$200/pr.
424G, 651G.....	\$210.00/pr. (L4)
Convertible Rear Panels	
.....	DO67GH00056(C)
100G, 325G, 338G, 501G ...	\$200/pr.
424G, 651G.....	\$210.00/pr. (L4)
Armrest/Well Covers (Convertible)	
.....	AW66GA00056(C)
100G, 325G, 338G, 501G ...	\$101.00/pr.
424G, 651G.....	\$106.00/pr. (L4)

This Legendary product features as-original Die-electrically heat sealed Madrid grain vinyl. Special cutout area in filler board to accommodate armrest base. Multi-Level Construction 3-Dimensional Panel.

NOTE: Customer must reuse original decorative trim and medallions. Medallions are available. See following section of catalog.

1968 CHEVELLE/MALIBU BUCKET & BENCH STYLE

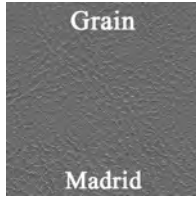
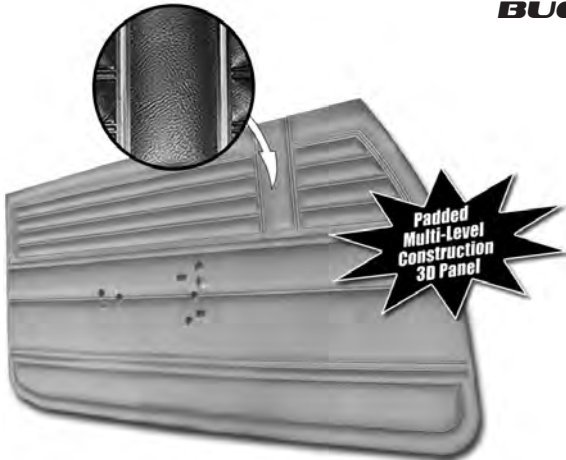

(C) COLOR CODES:
 (100G) Black
 (204G) Met. Parchment
 (331G) Medium Blue
 (333G) Light Blue
 (501G) Red
 (645G) Willow Gold

This Legendary product features as-original Madrid grain vinyl with chrome accent strips. Special cutout area in filler board to accommodate armrest base. Padded Multi-Level Construction 3-Dimensional Panel. NOTE: Customer must reuse original decorative trim and medallions. Medallions are available. See following section of catalog.

Front Panels (Unassembled).....	DO68GH00012(C)
100G, 204G, 331G, 501G	\$393/pr.
333G, 645G.....	\$413/pr. (L4)
Front Panels (Pre-assembled) ^{OS1}	DO68GH00012(C)-PA
100G, 204G, 331G, 501G	\$599/pr.
333G, 645G.....	\$629/pr. (L4)
☞ Includes original style upper metal rail, door lock ferrules & windowfelt strip.	
Htp Rear Panels (Unassembled).....	DO68GH00046(C)
100G, 204G, 331G, 501G	\$234/pr.
333G, 645G.....	\$246/pr. (L4)
Htp Rear Panels (Pre-assembled) ^{OS1}	DO68GH00046(C)-PA
100G, 204G, 331G, 501G	\$418/pr.
333G, 645G.....	\$439/pr. (L4)
Conv Rear Panels (Unassembled).....	DO68GH00056(C)
100G, 204G, 331G, 501G	\$234/pr.
333G, 645G.....	\$246/pr. (L4)
Conv Rear Panels (Pre-assembled) ^{OS1}	DO68GH00056(C)-PA
100G, 204G, 331G, 501G	\$418/pr.
333G, 645G.....	\$439/pr. (L4)
Convertible Armrest/Well Covers.....	AW68GA00056(C)
100G, 204G, 331G, 501G	\$101/pr.
333G, 645G.....	\$106/pr. (L4)

1968 CHEVELLE/MALIBU

"BUICK REPLACEMENT" STANDARD BENCH STYLE [TRIM CODE 765-118]

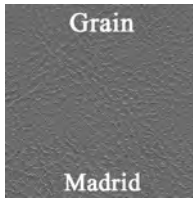

(C) COLOR CODES:
 (100G) Black

This Legendary product features as-original Madrid grain vinyl with chrome accent belt. Special cutout area in filler board to accommodate armrest base. Padded Multi-Level Construction 3-Dimensional Panel.

NOTE: Customer must reuse original decorative trim and medallions. Medallions are available. See following section of catalog.

Front Panels	DO68GHS0020(C)
(Unassembled)	\$443/pr.
Front Panels ^{OS1}	DO68GHS0020(C)-PA
(Pre-assembled)	\$637/pr.
☞ Includes original style upper metal rail, door lock ferrules & windowfelt strip.	
Hardtop Rear Panels	
(Unassembled)	DO68GHS0080(C)
(Pre-assembled) ^{OS1}	\$267/pr.
(Pre-assembled) ^{OS1}	DO68GHS0080(C)-PA
.....	\$508/pr.

1968 CHEVELLE/MALIBU

"BUICK REPLACEMENT" BUCKET & DELUXE BENCH STYLE
 [TRIM CODES 765-158, 765-168 & 766-178]

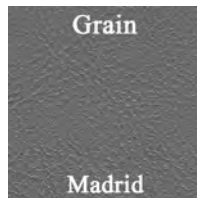
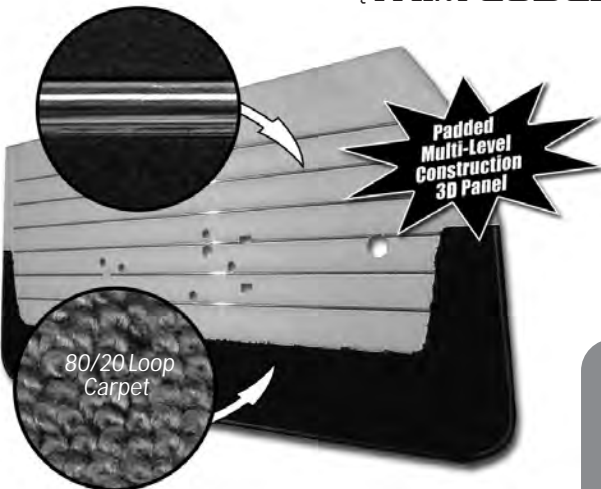

(C) COLOR CODES:
 (100G) Black

This Legendary product features as-original Madrid grain vinyl with chrome accent strips and carpeted lower section. Special cutout area in filler board to accommodate armrest base. Padded Multi-Level Construction 3-Dimensional Panel.

NOTE: Customer must reuse original decorative trim and medallions. Medallions are available. See following section of catalog.

Front Panels	
(Unassembled)	DO68GHD0012(C)
.....	\$443/pr.
(Pre-assembled) ^{OS1}	DO68GHD0012(C)-PA
.....	\$637/pr.
☞ Pre-assembled panels includes original style upper metal rail, door lock ferrules & windowfelt strip.	
Hardtop Rear Panels	
(Unassembled)	DO68GHD0048(C)
.....	\$267/pr.
(Pre-assembled) ^{OS1}	DO68GHD0048(C)-PA
.....	\$508/pr.
Convertible Rear Panels	
(Unassembled)	DO68GHD0056(C)
.....	\$267/pr.
(Pre-assembled) ^{OS1}	DO68GHD0056(C)-PA
.....	\$508/pr.
Armrest/Well Covers	
(Hardtop)	AW68GA00048(C)
.....	\$82/pr.
(Convertible).....	AW68GA00056(C)
.....	\$101/pr.



1968 CHEVELLE/MALIBU & EL CAMINO
"OLDSMOBILE REPLACEMENT" DELUXE BENCH STYLE [TRIM CODE 765-980]

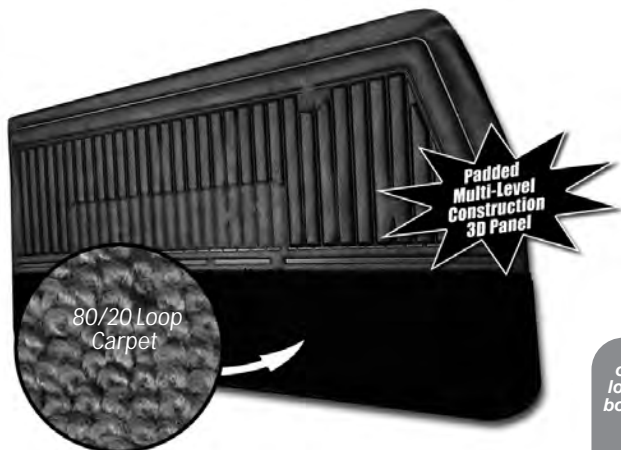

(C) COLOR CODES:
 (100G) Black

This Legendary product features as-original Madrid grain vinyl with carpeted lower section. Special cutout area in filler board to accommodate armrest base. Padded Multi-Level Construction 3-Dimensional Panel.
NOTE: Customer must reuse original decorative trim and medallions. Medallions are available. See following section of catalog.

Front Panels (Unassembled)	DO68GHD0020(C) \$461/pr.
Front Panels ^{OS1} (Pre-assembled)	DO68GHD0020(C)-PA \$710/pr.
<small>OS1 Includes original style upper metal rail, door lock ferrules & windowfelt strip.</small>	
Hardtop Rear Panels (Unassembled)	DO68GHD0080(C) \$279/pr.
(Pre-assembled) ^{OS1}	DO68GHD0080(C)-PA \$537/pr.
Hardtop Armrest/Well Covers	AW68GA00048(C) \$82/pr.

1968 EL CAMINO
BUCKET & BENCH STYLE

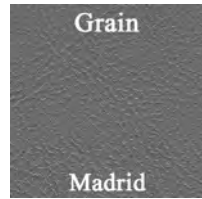
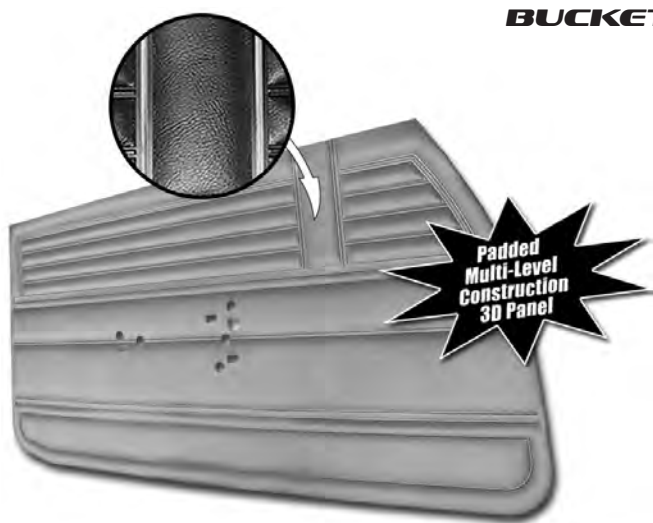

(C) COLOR CODES:
 (100G) Black
 (331G) Medium Blue
 (654G) Saddle
 (Requires Sample Approval)

This Legendary product features as-original Madrid grain vinyl with chrome accent strips. Special cutout area in filler board to accommodate armrest base. Padded Multi-Level Construction 3-Dimensional Panel.
NOTE: Customer must reuse original decorative trim and medallions. Medallions are available. See following section of catalog.

Front Panels 100G, 331G	DO68GE00011(C) \$393/pr.
654G	\$758/pr. (L1)
Front Panels ^{OS1} 100G, 331G	DO68GE00011(C)-PA \$599/pr.
654G	\$1065/pr. (L1)
<small>OS1 Includes original style upper metal rail, door lock ferrules & windowfelt strip.</small>	

1968 EL CAMINO
"PONTIAC REPLACEMENT" BUCKET STYLE [TRIM CODE 766-223]

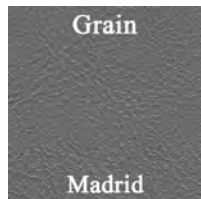

(C) COLOR CODES:
 (100G) Black

This Legendary product features as-original Die-electrically heat sealed Madrid grain vinyl with carpeted lower section. Special cutout area in filler board to accommodate armrest base. Padded Multi-Level Construction 3-Dimensional Panel.
NOTE: Customer must reuse original decorative trim and medallions. Medallions are available. See following section of catalog.

Front Panels (Unassembled)	DO68GED0011(C) \$482/pr.
Front Panels ^{OS1} (Pre-assembled)	DO68GED0011(C)-PA \$637/pr.

**1969 CHEVELLE/MALIBU
BUCKET & BENCH STYLE**

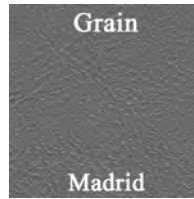

- (C) COLOR CODES:**
 (100G) Black
 (239G) Met. Parchment
 (369G) Metallic Blue
 (432G) Light Met. Green
 (469G) Dark Met. Green
 (511G) Red

This Legendary product features as-original Madrid grain vinyl with correct profile chrome accents. Panels also feature an exact reproduction of the Basketweave pattern. Special cutout area in filler board to accommodate armrest base. Padded Multi-Level Construction 3-Dimensional Panel. NOTE: Customer must reuse original decorative trim and medallions. Medallions are available. See following section of catalog.

Front Panels	DO69GH00012(C)
(Unassembled)	\$393/pr.
Front Panels ^{OS1}	DO69GH00012(C)-PA
(Pre-assembled)	\$599/pr.
<i>Includes original style upper metal rail, door lock ferrules & windowfelt strip.</i>	
Hardtop Rear Panels (Unassembled)	DO69GH00046(C)
(Pre-assembled) ^{OS1}	DO69GH00046(C)-PA
.....	\$418/pr.
Convertible Rear Panels (Unassembled)	DO69GH00056(C)
.....	\$234/pr.
(Pre-assembled) ^{OS1}	DO69GH00056(C)-PA
.....	\$418/pr.
Convertible Armrest/Well Covers	AW68GA00056(C)
.....	\$101/pr.

**1969 EL CAMINO
BUCKET & BENCH STYLE**

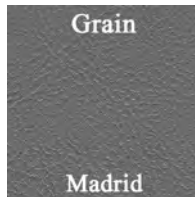
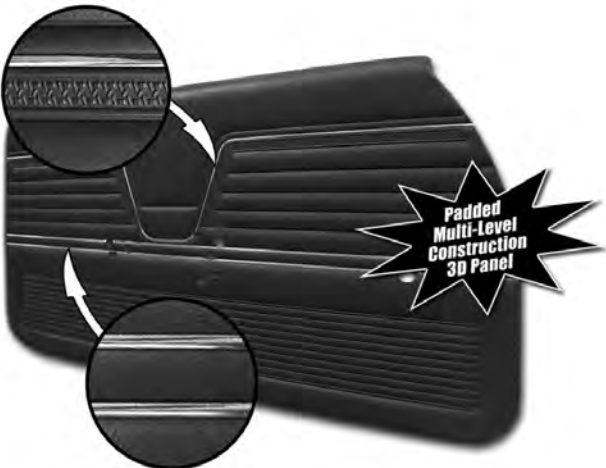

- (C) COLOR CODES:**
 (100G) Black
 (369G) Metallic Blue
 (654G) Saddle
 (Requires Sample Approval)

This Legendary product features as-original Madrid grain vinyl with correct profile chrome accents. Panels also feature an exact reproduction of the Basketweave pattern. Special cutout area in filler board to accommodate armrest base. Padded Multi-Level Construction 3-Dimensional Panel.
 NOTE: Customer must reuse original decorative trim and medallions. Medallions are available. See following section of catalog.

Front Panels	DO69GE00011(C)
100G, 369G	\$393/pr.
654G	\$758/pr. (L1)
Front Panels ^{OS1}	DO69GE00011(C)-PA
100G, 369G	\$599/pr.
654G	\$1065/pr. (L1)
<i>Includes original style upper metal rail, do or lock ferrules & windowfelt strip.</i>	

**1970 CHEVELLE/MALIBU
BUCKET & BENCH STYLE**

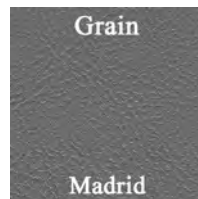
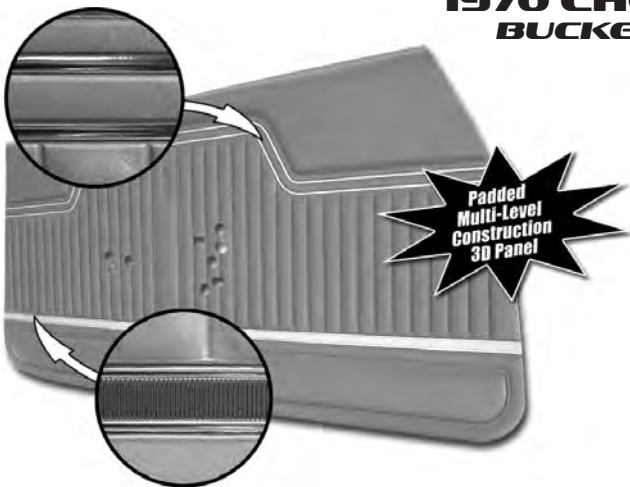

- (C) COLOR CODES:**
 (100G) Black
 (202G) Pearl White
 (310G) Light Metallic Blue
 (460G) Metallic Green
 (513G) Red
 (683G) Saddle

This Legendary product features as-original Madrid grain vinyl with correct profile chrome accents. Special cutout area in filler board to accommodate armrest base. Padded Multi-Level Construction 3-Dimensional Panel. NOTE: Customer must reuse original decorative trim and medallions. Medallions are available. See following section of catalog.

Front Panels	DO70GH00012(C)
(Unassembled)	\$393/pr.
Front Panels ^{OS1}	DO70GH00012(C)-PA
(Pre-assembled)	\$599/pr.
Hardtop Rear Panels (Unassembled)	DO70GH00048(C)
.....	\$234/pr.
(Pre-assembled) ^{OS1}	DO70GH00048(C)-PA
.....	\$418/pr
Convertible Rear Panels (Unassembled)	DO70GH00056(C)
.....	\$234/pr.
(Pre-assembled) ^{OS1}	DO70GH00056(C)-PA
.....	\$418/pr.
<i>460G Metallic Green was not available in convertible models.</i>	
Convertible Armrest/Well Covers	AW68GA00056(C)
.....	\$101/pr.



**1970 EL CAMINO
BUCKET & BENCH STYLE**

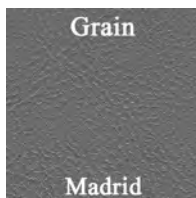
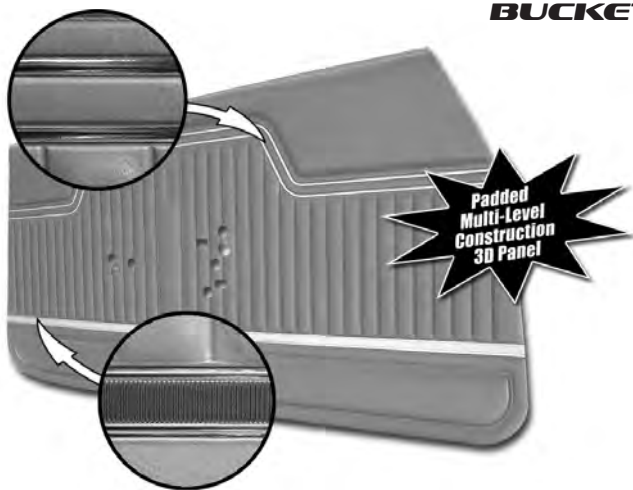

(C) COLOR CODES:
 (100G) Black
 (310G) Light Metallic Blue
 (683G) Saddle

Front Panels (Unassembled)	DO70GE00011(C) \$393/pr.
Front Panels ⁹⁵¹ (Pre-assembled)	DO70GE00011(C)-PA \$599/pr.

951 Includes original style upper metal rail, door lock ferrules & windowfelt strip.

This Legendary product features as-original Madrid grain vinyl with correct profile chrome accents. Special cutout area in filler board to accommodate armrest base. Padded Multi-Level Construction 3-Dimensional Panel.

NOTE: Customer must reuse original decorative trim and medallions. Medallions are available. See following section of catalog.

**1971-72 CHEVELLE/MALIBU
BUCKET & BENCH STYLE**

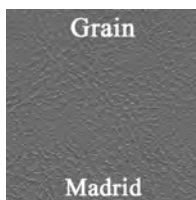
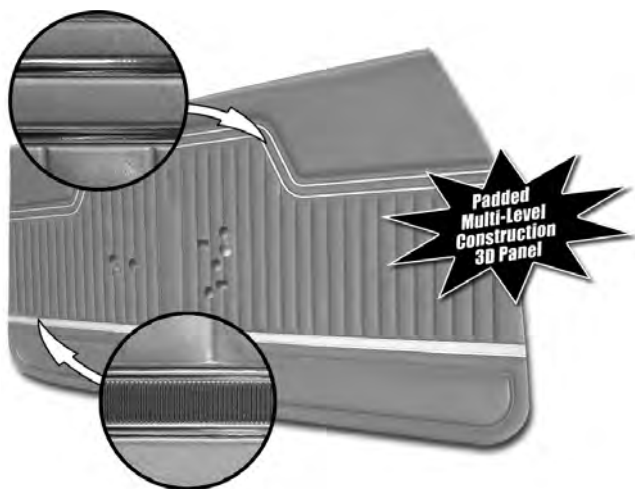

(C) COLOR CODES: (1971)
 (100G) Black
 (380G) Blue (Cloth Interior Only)
 (415G) Jade Green
 (690G) Saddle
 (697G) Sandalwood

(C) COLOR CODES: (1972)
 (100G) Black
 (230G) White
 (380G) Blue (Cloth Interior Only)
 (465G) Green
 (670G) Saddle
 (695G) Sandalwood

Front Panels (Unassembled)	DO70GH00012(C)
100G, 230G, 380G, 670G, 690G.....	\$393/pr.
695G	\$705/pr. (L1)
415G, 465G, 697G	\$413/pr. (L4)
Front Panels (Pre-assembled) ⁹⁵¹	DO70GH00012(C)-PA
100G, 230G, 380G, 670G, 690G.....	\$599/pr.
695G	\$947/pr. (L1)
415G, 465G, 697G	\$629/pr. (L4)
Htp Rear Panels (Unassembled).....	DO70GH00048(C)
100G, 230G, 380G, 670G, 690G.....	\$234/pr.
695G	\$402/pr. (L1)
415G, 465G, 697G	\$246/pr. (L4)
Htp Rear Panels (Pre-assembled) ⁹⁵¹	DO70GH00048(C)-PA
100G, 230G, 380G, 670G, 690G.....	\$418/pr.
695G	\$607/pr. (L1)
415G, 465G, 697G	\$439/pr. (L4)
Conv Rear Panels (Unassembled).....	DO70GH00056(C)
100G, 230G, 380G, 690G.....	\$234/pr.
415G, 465G	\$246/pr. (L4)
Conv Rear Panels (Pre-assembled) ⁹⁵¹	DO70GH00056(C)-PA
100G, 230G, 380G, 690G.....	\$418/pr.
415G, 465G	\$439/pr. (L4)

951 670G Saddle, 695G Sandalwood and 697G Sandalwood were not available in convertible models.

Convertible Armrest/Well Covers.....	AW68GA00056(C)
100G, 230G, 380G, 670G, 690G.....	\$101/pr.
415G, 465G, 697G	\$106/pr. (L4)

This Legendary product features as-original Madrid grain vinyl with correct profile chrome accents. Special cutout area in filler board to accommodate armrest base. Padded Multi-Level Construction 3-Dimensional Panel.

NOTE: Customer must reuse original decorative trim and medallions. Medallions are available. See following section of catalog.

**1971-72 EL CAMINO & GMC SPRINT
BUCKET & BENCH STYLE**

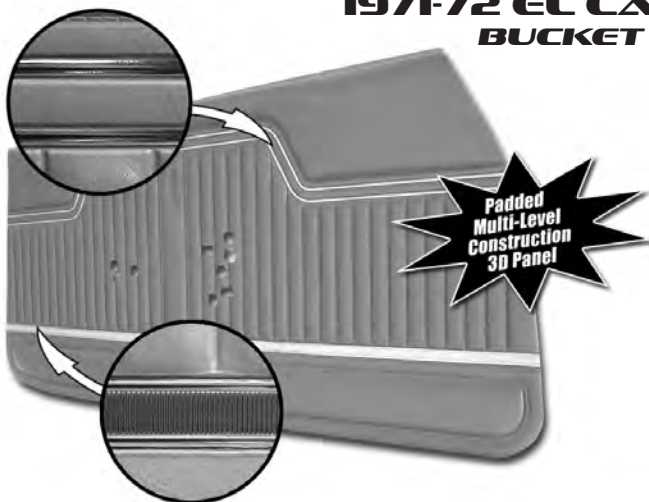

(C) COLOR CODES: (1971-72)
 (100G) Black (71-72)
 (380G) Blue (71)
 (415G) Jade Green (71)
 (670G) Saddle (72)
 (690G) Saddle (71)
 (695G) Sandalwood (72)
 (697G) Sandalwood (71)

Front Panels (Unassembled).....	DO70GE00011(C)
100G, 380G, 690G	\$393/pr.
695G.....	\$705/pr. (L1)
415G, 670G, 697G	\$413/pr. (L4)
(Pre-assembled) ⁹⁵¹	DO70GE00011(C)-PA
100G, 380G, 690G	\$599/pr.
695G.....	\$947/pr. (L1)
415G, 670G, 697G	\$629/pr. (L4)

951 Includes original style upper metal rail, door lock ferrules & windowfelt strip.

This Legendary product features as-original Madrid grain vinyl with correct profile chrome accents. Special cutout area in filler board to accommodate armrest base. Padded Multi-Level Construction 3-Dimensional Panel.

NOTE: Customer must reuse original decorative trim and medallions. Medallions are available. See following section of catalog.

1964-72 ARMREST PADS

Reproduction molded armrest pads are manufactured in the correct grains and texture as the originals. 1964 pads feature Seville grain, while 1965-72 feature authentic Madrid grain. For colors other than black, please specify at time of order.

1964-72 FRONT PADS



1964 Chevelle, Malibu & El Camino AP64GA-FRT

100G, 220G, 325G, 508G, 656G.....\$105.00/pr.
231G, 419G.....\$149.00/pr.
☞ These pads measure 11" in length.

1965-67 Chevelle, Malibu & El Camino AP65GA-FRT

100G, 220G, 325G, 420G, 511G.....\$105.00/pr.
140G, 420G, 679G.....\$149.00/pr.
☞ These pads measure 11" in length.

1968-72 Chevelle, Malibu & El Camino AP68GA-FRT

100G, 202G, 204G, 239G, 310G, 331G, 333G,
369G, 380G, 415G, 432G, 460G, 465G, 469G,
501G, 511G, 513G, 645G, 670G, 683G,
690G, 695G, 697G.....\$105.00/pr.
654G.....\$149.00/pr.
☞ These pads measure 11" in length.
☞ Please refer to door panel section for available colors.

1964-69 REAR PADS



1964 Chevelle & Malibu AP64GA-RR

100G, 220G, 325G, 508G, 656G.....\$105.00/pr.
231G, 419G.....\$149.00/pr.

1965-67 Chevelle & Malibu AP65GA-RR

100G, 220G, 325G, 420G, 511G.....\$105.00/pr.
140G, 420G, 679G.....\$149.00/pr.

1968-69 Chevelle & Malibu AP68GA-RR

100G, 204G, 239G, 331G, 333G, 369G, 432G,
469G, 501G, 511G, 645G, 679G.....\$95.00/ea.
☞ Coupe models only.
☞ Please refer to door panel section for available colors.

1964-67 ARMREST BASES

Chrome armrest bases are original-style injection molded plastic. Triple chrome plated, these are of a superior quality than others on the market. Available in pairs for both front and rear.



**1964-67 Chevelle, Malibu & El Camino
AP64GA-BASEFRT (Front) (shown) ...\$49.00/pr.**
☞ Uses 11" armrest pads.

**1964-67 Chevelle & Malibu
AP64GA-BASERR (Rear).....\$49.00/pr.**
☞ Fits all coupe models.

1969-72 ARMREST BASE CHROME BACK PLATE

Chrome back plates found on some, but not all, 1969-72 models. Factory exact and ready to install. Will not work for 1968 models.



**1969-72 Chevelle, Malibu & El Camino
AP69GA-BASECHR (Front)\$49.00/pr.**

1968-72 ARMREST BASES

High-quality reproduction injection molded plastic bases have the original texture and grain as the originals.



**1968-72 Chevelle, Malibu & El Camino
AP68GAF-BASELH (Left Front).....\$29.00/ea.
AP68GAF-BASERH (Right Front).....\$29.00/ea.**

1964-72 REAR ARMREST COVERS

Convertible armrest covers are made in-house to original specifications and feature the correct vinyl colors and grains to match our upholstery. Please specify color at time of order.



**1964 Chevelle & Malibu
AW64GA00056(C) \$101.00-\$106.00/set**
☞ Please see door panel section for available colors.

**1965 Chevelle & Malibu
AW65GA00056(C) \$101.00-\$106.00/set
679G\$225.00/pr. (L1)**
☞ Please see door panel section for available colors.

**1966-67 Chevelle & Malibu
AW66GA00056(C) \$101.00-\$106.00/set**
☞ Please see door panel section for available colors.

**1968-72 Chevelle & Malibu
AW68GA00056(C) \$101.00-\$106.00/set**
☞ Please see door panel section for available colors.

1970-72 REAR ARMREST PANELS

ABS plastic reproduction rear armrest panels. This kit includes the side of seat vertical panels as well. Please specify color listed below at time of order.



**1970-72 Chevelle & Malibu
AW70GA00048(C) \$119.00/kit**

(C) COLOR CODES

(01) Black	(07) Dark Blue
(03) Red	(13) Dark Green

1968-69 STAINLESS ARMREST BASE MOLDING

Factory-correct armrest molding found on some, but not all 1968-69 models.

**1968-69 Chevelle, Malibu & El Camino
AP68GA-BASETRIM\$49.00/pr.**
☞ Holes will need to be drilled on bases for installation.



ASHWELL INSTALLATION PAD KITS

Ashwell installation pad kits for 1964-72 Chevelle & Malibu Hardtop and Convertible models.



1964-67 Chevelle & Malibu (hardtop)
INSTALLATION-AW1.....\$39.00/kit

Kit includes: (2) 20oz. board w/ 5oz. felt attached,
 (2) 20oz. felt & (2) 40oz. felt



1968-72 Chevelle & Malibu (hardtop)
INSTALLATION-AW3.....\$39.00/kit

Kit includes: (2) 20oz. board w/ 5oz. felt attached,
 (2) 20oz. felt & (2) 40oz. felt

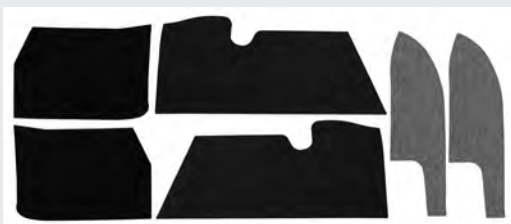

1964-67 Chevelle & Malibu (convertible)
INSTALLATION-AW2.....\$39.00/kit

Kit includes: (2) 20oz. board w/ 5oz. felt attached,
 (2) 5oz. felt & (2) 20oz. felt



1968-72 Chevelle & Malibu (convertible)
INSTALLATION-AW4.....\$39.00/kit

Kit includes: (2) 20oz. board w/ 5oz. felt attached,
 (2) 5oz. felt & (2) 20oz. felt

DOOR PANEL WATERSHIELDS

Die-cut watershields are designed to protect your door panels from moisture. Sold as a complete set of 4 for front and rear panels.

1964-67 Chevelle, Malibu & El Camino

DO64GAWATERH (Hardtop)\$39.00/set
DO64GAWATERC (Convertible).....\$39.00/set

1968-72 Chevelle, Malibu & El Camino

DO68GAWATERHS (1968-69 Sport Cpe) ..\$39.00/set
DO68GAWATERH (1970-72 Sport Cpe) ..\$39.00/set
DO68GAWATERS (1968-72 Coupe)....\$39.00/set
DO68GAWATERC (Convertible).....\$39.00/set

1968-72 ARMREST BASE SCREW SET

These Phillips head sheet metal screws fasten the armrest base to the door. Set of (6).

1968-72 Chevelle, Malibu & El Camino

AP68GA-SCREW (Set/6)\$10.00/set

DOOR LOCK FERRULES

Authentically reproduced ferrules support the door lock knob.



BT64GAFERRULE

BT68GAFERRULE

1964-67 Chevelle, Malibu & El Camino

BT64GAFERRULE (Clear plastic)\$9.00/pr.

1968-72 Chevelle, Malibu & El Camino (shown)

BT68GAFERRULE (Stainless steel).....\$2.00/ea.
 Kit includes the correct inner felt ring as original.

DOOR LOCK KNOBS



Complete your door trim restoration with new door lock knobs. Available in black or chrome.

1964-67 Chevelle, Malibu & El Camino

BT67GA (Chrome w/ "tuliped" head)....\$15.00/pr.

1968-72 Chevelle, Malibu & El Camino (shown)

BT68GA (Chrome w/ ribbed shaft).....\$19.00/pr.

DOOR PANEL MEDALLIONS



1966 Chevelle, Malibu & El Camino

DO66GHE-EMBLEM (Medallion).....\$76.00/set
 Kit includes Set of 4.

1967 Chevelle, Malibu & El Camino

DO67GHE-EMBLEM (Medallion).....\$98.00/set
 Kit includes Set of 8.

1968 Chevelle, Malibu & El Camino

DO68GHE-EMBLEM "SS 396"\$65.00/pr.

1969 Chevelle, Malibu & El Camino

DO69GHE-EMBLEM "SS 396".....\$54.00/pr.

1970-72 Chevelle, Malibu & El Camino

DO70GHE-EMBLEM (Medallion).....\$43.00/pr.
DO70GHE-EMBLEMSS "SS".....\$54.00/pr.

Chevrolet

1964-67 DOOR JAMB WINDLACE



This quality replacement molded windlace features the original bumpy grain vinyl with the steel insert to clip to the door jamb edge lip. Available in black, lt. blue, dk. blue, fawn, saddle, (64) red, (65-67) red and white. Please specify color at time of order.

1964-67 Chevelle, Malibu & El Camino
WI64GA(C).....\$49.00/pr.
 ☞ Will also work for convertible models.

1964-67 UPPER DOOR JAMB END CAPS

Exact reproduction endcaps screw to the upper door jamb and give that finished look by covering the end of the windlace seal. Available in black only.



1964-65 Chevelle & Malibu
WI64GA-CAPH (Hardtop/Coupe).....\$329.00/
 pr.
WI64GA-CAPC (Convertible).....\$39.00/pr.

1966-67 Chevelle & Malibu
WI66GA-CAPHC.....\$29.00/pr.
 ☞ Fits both hardtop and convertible models.

1964-72 CONVERTIBLE COURTESY LIGHT LENS & BEZELS



These quality reproduction lens & bezels mount to the rear armrest on convertible models. The lens is reproduced in the correct "eggshell" white while the bezel is manufactured using NOS tooling.

1964-72 Chevelle & Malibu
LL64GA-CBEZEL (Bezel only)\$35.00/ea.
LL64GA-CLENS (Lens only).....\$10.00/ea.

DOOR SILL PLATES



Replace your old scratched-up sill plates with a pair of these exact reproductions. Precision manufactured using the correct aluminum and anodized finish featuring the "Body by Fisher" tags.
 * Do not come with screws, must supply own.

1964-67 Chevelle, Malibu & El Camino
SP64GA\$79.00/pr.

1968-72 Chevelle, Malibu & El Camino
SP68GA\$99.00/pr.

1968-69 DOOR PANEL WINDLACE



Made as original with Madrid grain vinyl, rubber cord and die-cut panel board. This windlace installs on the front edge of the rear quarter panels and is a decorative and functional wind seal. Made as original for both non-post and convertible models. Please specify color at time of order.



1968-69 Chevelle & Malibu
WI68GA00048(C) (Htp & Conv.) ..\$98.00-\$103.00/pr.

1964-66 & 1968 DOOR PANEL LOWER TRIM MOLDING



Door panel moldings made of extruded aluminum feature stainless steel fold over tabs. These moldings attach to the front of the door panel and cover the area where the lower carpet trim and vinyl meet.

1964-66 Chevelle, Malibu & El Camino
TA64GA-TRIMFRT (Front).....\$54.00/pr.
TA64GA-TRIMRR (Coupe rear).....\$32.00/pr.

1968 Chevelle, Malibu & El Camino
TA68GA-TRIMFRT (Front).....\$39.00/pr.

1964-72 ASHTRAYS

These ashtrays are constructed from stainless steel and fit just like the originals. Available for both hardtop and convertible models.



1964-67 Chevelle & Malibu
AT64GA-H (Hardtop)\$59.00/pr.
AT64GA-C (Convertible)\$59.00/pr.
 ☞ Bezels included for convertible models.

1968-69 Chevelle & Malibu
AT67GCF (Convertible)\$65.00/ea.

1968-69 Chevelle & Malibu (shown)
AT68GA-HC (Hardtop)\$54.00/ea.

1970-72 Chevelle & Malibu
AT68GA-H (Hardtop & Convertible)\$59.00/ea.

DOOR PANEL CLIPS & RETAINERS



1964-72 Chevelle, Malibu & El Camino
DOGACLIPS (Shown left).....\$14.00/kit
 ☞ Kit includes 18 clips and 12 trim screws which are enough to install a pair of door and rear quarter panels.

1964-72 Chevelle, Malibu & El Camino
DOGARETAIN (Pkg/12) (Shown right).\$11.00/pk.



DOOR HANDLES



Chrome reproduction inner door handle for all 1964 models that use an 11" armrest pad.

1964 Chevelle, Malibu & El Camino
CK64GHU-DOOR\$29.00/ea.



Chrome reproduction inner door handle for all 1965-67 models that use an 11" armrest pad.

1965-67 Chevelle, Malibu & El Camino
CK65GA-DOOR\$21.00/ea.



Chrome reproduction inner door handles for 1968-72 models.

1968-72 Chevelle, Malibu & El Camino
CK68GA-DOORLH (Left).....\$21.00/ea.
CK68GA-DOORRH (Right).....\$21.00/ea.

WINDOW CRANK HANDLES



Die-cast reproduction of the original front and rear window crank handle for all 1964 models.

1964 Chevelle, Malibu & El Camino
CK64GHU-WNDW (Chrome knob)\$19.00/ea.



Die-cast reproduction of the original chrome front and rear window crank handle for all 1965-66 models.

1965-66 Chevelle, Malibu & El Camino
CK65GA-WNDW (Chrome knob).....\$19.00/ea.



Die-cast reproduction of the original chrome front and rear window crank handle for all 1967-72 models.

1967-72 Chevelle, Malibu & El Camino
CK67GA-WNDW01 (Black knob).....\$17.00/ea.
CK67GA-WNDW02 (Clear knob).....\$17.00/ea.

1964-67 VENT WINDOW HANDLES



Duplicated to exact GM specifications with a brilliant chrome finish. These die-cast vent handles come with roll pins and spring washers.

1964-65 Chevelle, Malibu & El Camino
CK64GA-VENTLH (Left)\$29.00/ea.
CK64GA-VENTRH (Right)\$29.00/ea.

1966-67 Chevelle, Malibu & El Camino
CK66GA-VENT\$49.00/pr.

1968-72 VENT WINDOW CRANKS



Reproduction vent window cranks for all 1968 Chevelle/Malibu models and 1968-72 El Camino with vent windows.

1968-72 Chevelle, Malibu & El Camino
CK68GA-VENT01 (Black).....\$19.00/ea.
CK68GA-VENT02 (Clear).....\$19.00/ea.

DOOR & WINDOW HANDLE PLASTIC WASHER



Injection molded plastic washers protect the door panel from wear when door and window handles are being used.

1964-72 Chevelle, Malibu & El Camino
CK64GA-SPACER\$3.00 /ea.

WINDOW HANDLES SPRINGS



This spring goes behind the window crank handle and plastic washer to prevent vibration and rattling.

1964-72 Chevelle, Malibu & El Camino
CK64GA-SPRING\$3.00/ea.

DOOR & WINDOW HANDLE RETAINING CLIP



1964-72 Chevelle, Malibu & El Camino
CK64GA-CLIP.....\$1.00/ea.

Chevrolet

OUTER DOOR HANDLES



Highly polished chrome plated door handles are exact replicas of the original GM part. Includes all gaskets and mounting hardware.

1968-69 Chevelle
CK68GH-OUTDOOR \$69.00/pr.

1970-72 Chevelle
CK70GH-OUTDOOR \$79.00/pr.



Highly polished chrome plated door handles are exact replicas of the original GM part. Includes all gaskets and mounting hardware.

1968-72 El Camino
CK68GE-OUTDOOR \$69.00/pr.

DOOR HANDLE & LOCK GASKETS



Die-cut rubber gasket sets include door handle, door lock and trunk lock gaskets.

1968-72 Chevelle, Malibu & El Camino
GK64GHE-LOCKDT \$19.00/set

DOOR LOCK STRIKER



These door strikers feature the same hardened steel as the originals and should be used to replace damaged or fatigued originals.

1964-72 Chevelle, Malibu & El Camino
DO64GA-STRIKER \$19.00/ea.

UPPER DOOR HINGES



These are OEM-quality hinges and are made to factory specifications. They are fantastic reproductions of the original hinges and they're completely assembled for easy installation.

1966-67 Chevelle, Malibu & El Camino (shown)
DO66GA-HINGEU \$59.00/ea.

1968-72 Chevelle, Malibu & El Camino
DO68GA-HINGEU \$89.00/ea.

LOWER DOOR HINGES



1968-72



These are OEM-quality hinges and are made to factory specifications. They are fantastic reproductions of the original hinges and they're completely assembled for easy installation.

1966-67 Chevelle, Malibu & El Camino
DO66GA-HINGELP (passenger) \$79.00/ea.
DO66GA-HINGELD (driver) \$79.00/ea.

1968-72 Chevelle, Malibu & El Camino
DO68GA-HINGELP (passenger) \$89.00/ea.
DO68GA-HINGELD (driver) \$99.00/ea.

SEAT BELT BOLTS



1964-66 Chrome Plated 1964-66 Cad Plated 1967-72 Chrome Plated

The bolt heads are the factory-sized 13/16" and fit and function just like the originals and come in either a cad-plated or chrome finish.

1964-72 Chevelle, Malibu & El Camino
BA64GA-BOLT (Chrome) \$15.00/ea.
BA64GA-BOLTC (Cad) \$15.00/ea.
BA67GA-BOLT (Chrome) \$15.00/ea.

JUTE BACKING

This insulating material when placed between the floorpan and molded carpet enhances sound barrier protection from road noise and adds cushion to your carpet. Also helpful for insulating headliners, trunk areas and more.



36"x36" cut

TA200ZFELT (20 oz.) \$19.00/yd.
TA400ZFELT (40 oz.) \$29.00/yd.

LOWER DOOR HINGE PINS

Hardened shouldered pivot pins

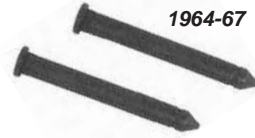

1964-67

1964-67 Chevelle, Malibu & El Camino
DO64GA-HINGEPIN \$8.00/ea



1968-72

1968-72 Chevelle, Malibu & El Camino
DO68GA-HINGEPIN \$10.00/ea

HINGE TO DOOR BOLTS



Made to exact GM specifications for proper fit.

1968-72 Chevelle, Malibu & El Camino
DO68GA-BOLTS (set of 24) \$49.00/set

LOWER DOOR SPRING



Direct replacement for missing or broken door hinge springs. Same size and spring rate as original part.

1965-67 Chevelle, Malibu & El Camino
DO65GA-SPRING \$15.00/ea.







CARPETS, FLOORMATS AND ACCESORIES

 facebook.com/legendaryautointeriors

 twitter.com/legendaryautoin

 www.legendaryautointeriors.com

 instagram.com/legendaryautointeriorsltd

 youtube.com/user/legendaryauto



MODEL SPECIFIC CARPET

Legendary brand molded carpets utilize the heaviest face weight cutpile and loop carpet combined with an extra heavy poly coated backing that provides for an accurate and sharply detailed mold formed area. Surged edges and accurately die cut and applied 40oz. felt underlayment is the finishing touch to our vehicle specific carpets.

Bound and Surged Edges

Both Legendary cutpile and loop molded carpets have a heavy duty bound and surged edge that provides for an easy installation and clean appearance.



Underlayment Padding

Legendary molded carpets are made with a 40 oz. felt underlayment padding. All padding is trimmed around seat track mounts, seat belt holes and covers the most area than any carpet in the industry!



80/20 LOOP CARPET COLOR SELECTOR (c)

01 BLACK	03 RED	04 AQUA	05 DARK TEAL	06 FORD BLUE	07 DARK BLUE	08 TEAL	09 SHADE 13 BLUE
10 BRIGHT BLUE	11 MEDIUM BLUE	12 GREEN	13 DARK GREEN	14 DARK OLIVE GREEN	15 BLUE GREEN	16 MOSS GREEN	21 MEDIUM RED
22 BURNT ORANGE	24 ROSE BEIGE	25 DARK BROWN	26 SADDLE	27 LT/MEDIUM SADDLE	28 DARK COPPER	29 DARK SADDLE	31 MAROON
32 GOLD	33 DARK GOLD	34 FAWN	35 RED TUXEDO	36 BLUE TUXEDO	37 AQUA TUXEDO	38 LIGHT GREEN	39 ORANGE
40 PLUM	41 SUNSET GLOW	42 SILVER MINK	44 CORAL	45 EMBER GLOW	46 IVY GOLD	47 FAWN TUXEDO	48 SILVER
49 GUNMETAL GRAY	50 PARCHMENT	51 MIDNIGHT BLUE	53 GOLD TUXEDO	54 COPPER TUXEDO	55 OLIVE TUXEDO	81 CHARCOAL	

**36oz. JUTE PADDING INCLUDED WHERE PADDING WAS ORIGINAL.

**VINYL BOUND EDGE WHERE THE FRONT AND REAR SECTIONS OF THE CARPET OVERLAP.

**COLOR MATCHED ORIGINAL HEEL PAD ACCURATELY APPLIED USING THE SAME METHOD AS OEM.

**MEETS OR EXCEEDS OEM SPECIFICATIONS.

**DIMMER SWITCH GROMMET INCLUDED.

**COLOR SAMPLES ARE AVAILABLE FOR COLORS OTHER THAN BLACK.

**DYE LOTS WILL VARY +/- 10%. THIS IS COMMON IN THE CARPET INDUSTRY. CUSTOMERS ARE ENCOURAGED TO ORDER ALL CARPETED PRODUCTS AT THE SAME TIME TO ENSURE MATCHING DYE LOT.

**FOR YEARS AND MODELS NOT LISTED PLEASE CALL OUR SALES DEPARTMENT AT 800-363-8804

CARPET (NYLON LOOP)

The finest available today. Two-piece pre molded shape made with an original specification blend of 100% Nylon. All carpets include 36oz. jute padding on the back-side, dimmer switch grommet, color matched original style heel pad and vinyl bound edge where the front and rear sections overlap. Carpet kits are not shipped with pre-cut holes. This must be done during installation of carpet. Some other minor trimming may be needed. For years and models not listed please call our sales department for more information. We are able to get carpet kits for many other Chevrolet models and years not shown.



1964-67 Chevelle & Malibu

CA64GHA(C) (2-door/Automatic).....\$205.00/ea.
CA64GHS(C) (2-door/Manual).....\$205.00/ea.

1964-67 El Camino

CA64GEA(C) (Automatic).....\$205.00/ea.
CA64GES(C) (Manual).....\$205.00/ea.

Need additional carpet? We offer carpet yardage in 1yd. and 2yd. cuts. Please specify color at time of order. We highly recommend purchasing extra yardage along with your carpet kit to ensure color match.

Loop Carpet

CAYD(C) (1 yard).....\$79.00/yd.

1968-72 Chevelle & Malibu

CA68GHA(C) (2-door/Automatic)....\$205.00/ea.
CA68GHS(C) (2dr. Man. w/o console) \$205.00/ea.
CA68GHSW(C) (2dr. Man. w/ console) \$205.00/ea.

1968-72 El Camino

CA68GEA(C) (2-door/Automatic)....\$205.00/ea.
CA68GES(C) (2dr. Man. w/o console) \$205.00/ea.
CA68GESW(C) (2dr. Man. w/ console) \$205.00/ea.

KICK PANELS

Reproduction plastic kick panels made for models with factory air conditioning. These will also fit non-air conditioning models, but do not have the fresh-air outlet vents. Available in black only.



1964 Chevelle, Malibu & El Camino

KI64GA100.....\$159.00/pr.

1965-66 Chevelle, Malibu & El Camino

KI65GA100.....\$159.00/pr.

1967 Chevelle, Malibu & El Camino

KI67GA100 (shown).....\$159.00/pr.

1968-72 Chevelle, Malibu & El Camino

KI68GA100.....\$149.00/pr.

SOUND DEADENER

This heavyweight material installs under the carpet directly against the floorpan to reduce heat and noise. Pre-cut to correct shape and size.

1964-67 Chevelle, Malibu & El Camino

SD64GA.....\$99.00/ea.

1968-72 Chevelle, Malibu & El Camino

SD68GA.....\$99.00/ea.

FIREWALL INSULATION



Die-cut jute insulation pad comes complete with a stamped rubber backing on one side like the originals. This insulation fastens to and runs the entire length of the firewall to help reduce engine heat and noise. Insulation clips included.

1964-67 Chevelle, Malibu & El Camino

F164GA (w/o air conditioning).....\$65.00/ea.

F164GA-W/A (with air conditioning)...\$65.00/ea.

1968-72 Chevelle, Malibu & El Camino

F168GA-W/O (w/o air conditioning) ...\$65.00/ea.

F168GA-W/A (with air conditioning)...\$65.00/ea.

OEM FIREWALL INSULATION

Firewalls are cut and punched with standard factory holes and are shipped ready-to-install with the appropriate "period" insulation attached.

1964-67 Chevelle, Malibu & El Camino

F164GAO (w/o air conditioning).....\$298.00/ea.

F164GAO-W/A (with air conditioning) \$298.00/ea.

1968-72 Chevelle, Malibu & El Camino

F168GAO (w/o air conditioning).....\$298.00/ea.

F168GAO-W/A (with air conditioning) \$298.00/ea.

KICK PANEL INSULATION



Die-cut jute insulation pads fit between the plastic kick panel and the body sheet metal to protect from moisture.

1964-67 Chevelle, Malibu & El Camino

KI64GA (shown).....\$17.00/pr.

1968-72 Chevelle, Malibu & El Camino

KI68GA.....\$17.00/pr.

FIREWALL GUARD FASTENER



These fasteners will help keep your carpet guard and carpet in their proper positions.

1967-69 Firebird

FI-FASTENER (set of 4).....\$17.00/set.





Providing the automotive industry
with the world's highest quality
soft trim products and services
RIGHT HERE AT HOME

STILL ASSEMBLED AND
MADE IN THE ★★★★★
USA 

THERE REALLY IS A DIFFERENCE!!

Legendary
AUTO INTERIORS LTD.

www.legendaryautointeriors.com





LEGENDARY'S CUSTOM VINTAGE RUBBER STYLE FLOORMATS

DESIGNED TO FIT WHOLE FLOORPAN OF CAR LOGOS ON FRONT AND REAR MATS

How many times have you wished for automotive floormats that have floorpan shapes, that are easily cleanable and also have that "factory original" styling that would make you proud to display them in your classic car? Our "Custom Vintage" rubber style floormats will please the most discriminating buyer and provide years of carefree use.



www.legendaryautointeriors.com

CUSTOM DESIGN FLOORMATS

AVAILABLE IN ALL YEARS,
MAKES AND MODELS



**1 Color
insert**

Adds \$25 to base price

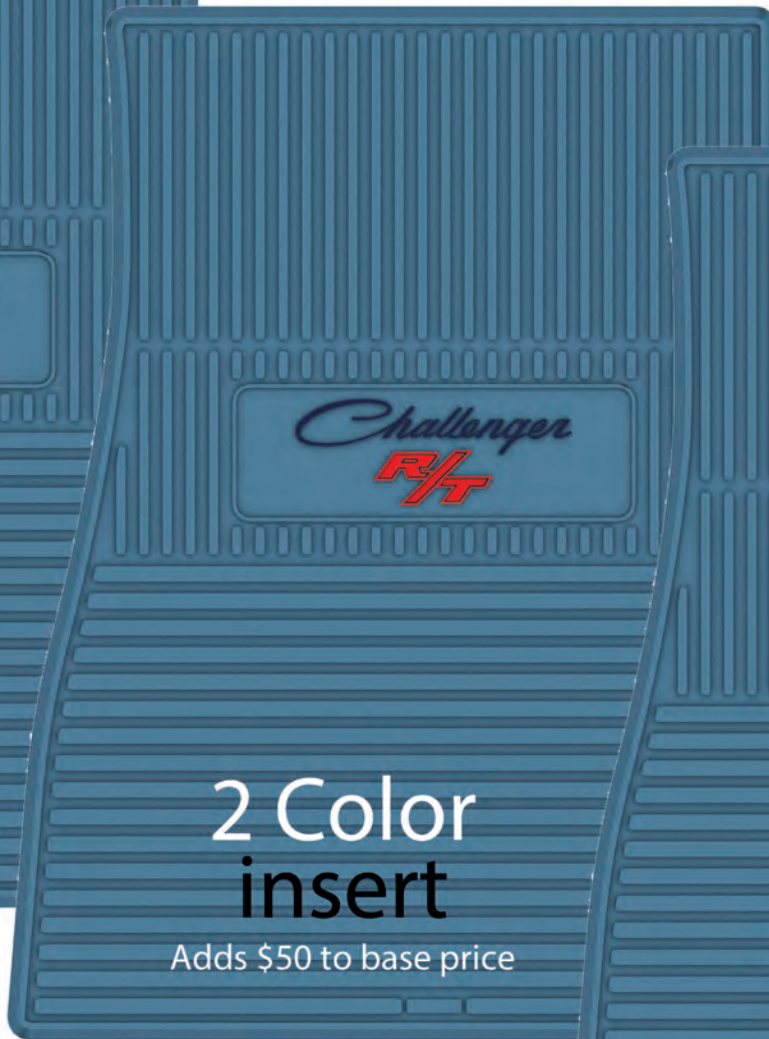

**2 Color
insert**

Adds \$50 to base price

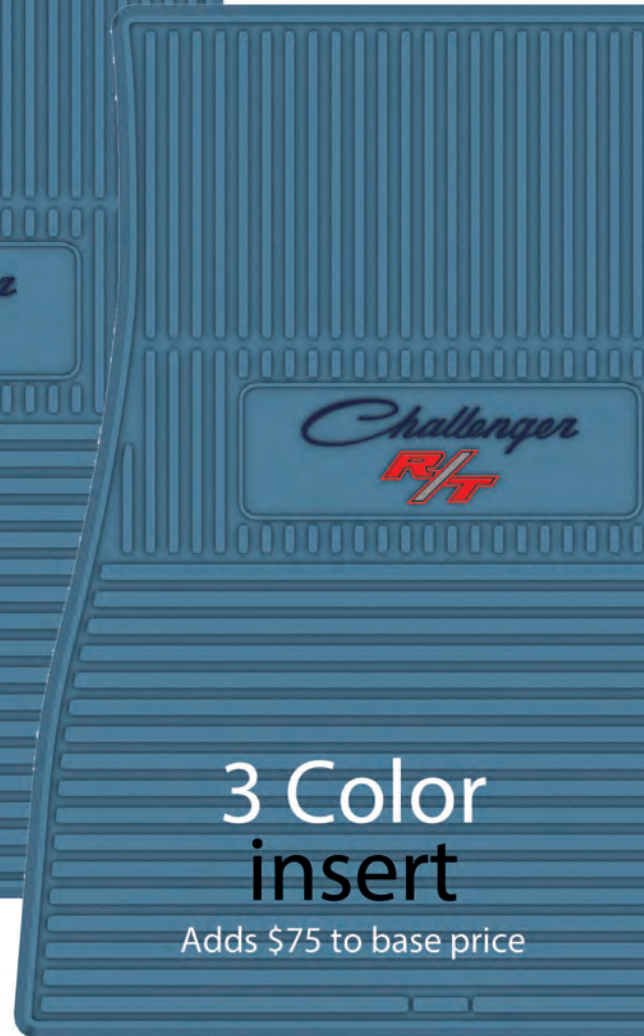

**3 Color
insert**

Adds \$75 to base price

**DESIGN YOUR OWN
INSERTS & COLORS**

www.legendaryautointeriors.com



FLOORMAT BASE & INSERT COLORS

BASE COLORS

001 Black - 002 White - 007 Dark Blue - 011 Medium Blue - 018 Bright Red - 020 Red - 023 Tan - 031 Maroon
 033 Dark Gold - 037 Aqua - 050 Turquoise - 051 Lime Green - 054 Purple - 057 Dk Olive Green
 074 Pink - 079 Gray - 098 Brown - 129 Dark Saddle - 132 Gold

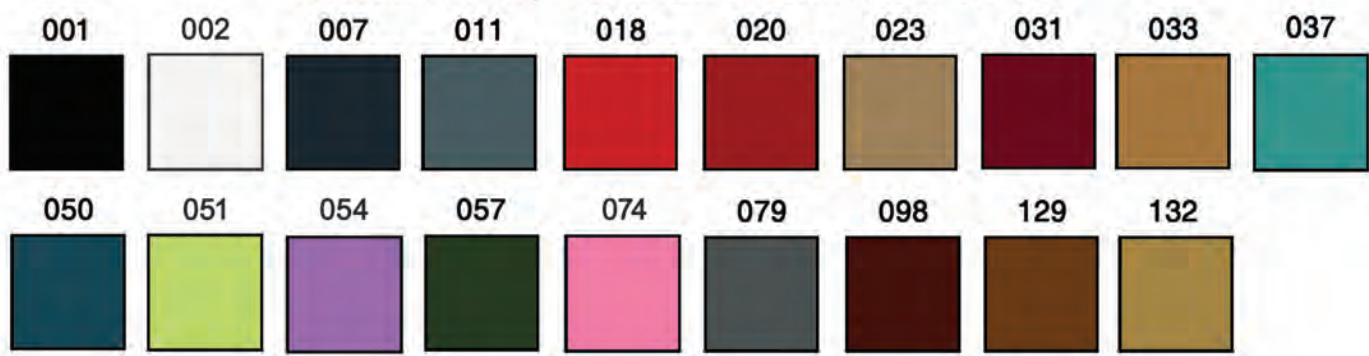

INSERT COLORS

133 Cream - 134 Sandalwood - 137 Aztec Gold - 138 Buckskin - 139 Sienna - 141 Coffee Bean - 142 Football
 143 Basketball - 150 Lemon Twist - 151 Mellow Yellow - 154 Plum Crazy - 156 Sky Blue - 157 Light Blue
 159 Pacific Blue - 160 Caribbean Blue - 161 Royal Blue - 163 Navy Blue - 165 Sassy Grass - 166 Pine
 167 Mint Green - 168 Hunter Green - 169 Antique Green - 170 Aqua Marine - 171 Mango - 173 Sunset Orange
 174 Panther Pink - 176 Cherry Red - 177 Cranberry - 178 Razzberry - 179 Garnet - 180 Smoke
 181 Platinum - 182 Medium Grey - 183 Silver - 184 Charcoal

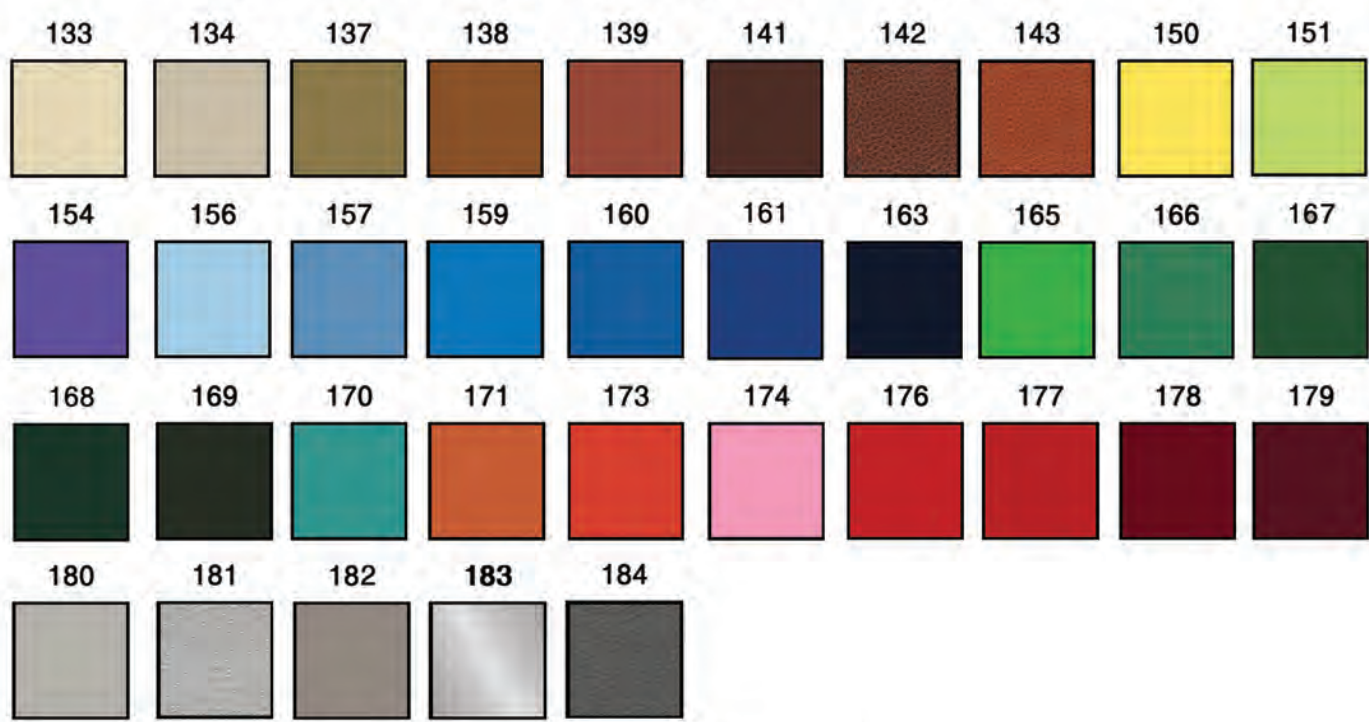

***Note - To order mats with colored inserts please call our sales department**

Actual colors will vary from samples on this page. Contact our Sample Request Department for actual color samples at 1-800-363-8804 or send us an email through our Sample Request Center on our website at www.legendaryautointeriors.com



1964-72 CHEVROLET CHEVELLE & MALIBU

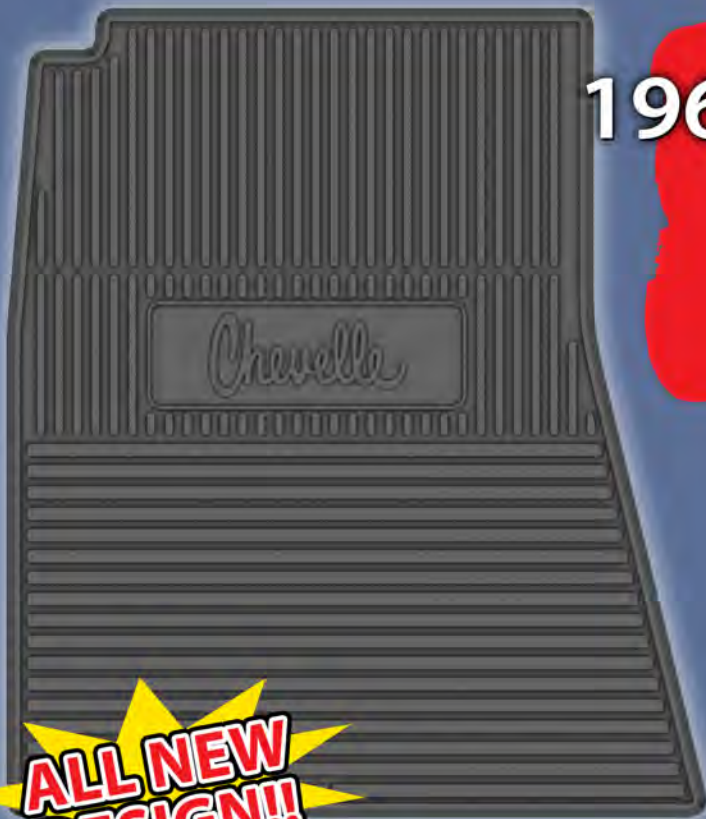

SURE-GRIP™
CORTEX ANTI-SLIP BACKING



www.legendariautointeriors.com

**ALL NEW
DESIGN!!**

**FLOORMAT PRICING:
ALL COLORS - \$229.00/set**

1964 Chevelle - Block letters w/ flag emblem
FMCL0001008(C)

1964 Malibu - Script letters w/ flag emblem
FMCL0001002(C)

1964 Malibu - Script letters w/ SS
FMCL0001003(C)

1965 Malibu Chevelle - Script letters
FMCL0001004(C)

1965 Malibu - Script letters w/ SS
FMCL0001005(C)

1966 Chevelle SS - Super sport
FMCL0001009(C)

1966-67 Chevelle - Block letters w/ flag emblem
FMCL0001001(C)

1966-67 SS - SS 396
FMSS0003003(C)

1966-67 Malibu - Script letters w/ flag emblem
FMCL0001007(C)

1967 Chevelle SS - Super sport
FMCL0001010(C)

1968-69 Chevelle - Script letters
FMCL0002003(C)

1968-69 Chevelle - Script letters w/ SS
FMCL0002006(C)

1968 Malibu - Script letters
FMCL0002001(C)

1968-72 SS - SS 396
FMSS0004006(C)

1969-72 Malibu - Block letters w/ bowtie
FMCL0002005(C)

1970-72 Chevelle - Script letters
FMCL0002004(C)

1970-72 Chevelle - Script letters w/ SS
FMCL0002002(C)

1970-72 SS - SS 454
FMSS0004004(C)

1964 Chevelle



1964 Malibu



1964 Malibu SS



1965 Malibu Chevelle

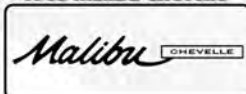

1965 Malibu SS

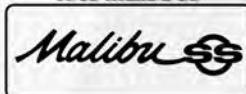

1966 Chevelle SS



1966-67 Chevelle



1966-72 SS 396



1966-67 Malibu

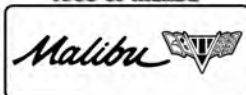

1967 Chevelle SS



1968-69 Chevelle



1968-69 Chevelle SS



1968 Malibu

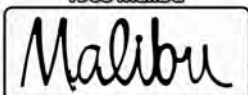

1969-72 Malibu



1970-72 Chevelle

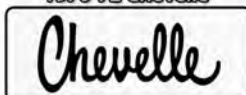

1970-72 Chevelle SS



1970-72 SS 454



1964-72 CHEVROLET EL CAMINO



SURE-GRIP™
CONTRIBUTE ANTI-SKID BACKING



www.legendariautointeriors.com

FLOORMAT PRICING:
ALL COLORS - \$209.00/set

**ALL NEW
DESIGN!!**

1964 El Camino - Block letters w/ bowtie
FMEC0001001(C)

1965 El Camino - Block letters w/ bowtie
FMEC0001004(C)

1966 El Camino - Block letters w/ large bowtie
FMEC0001006(C)

1966-67 SS - SS 396
FMSS0003004(C)

1967 El Camino - Block letters w/ bowtie
FMEC0001008(C)

1968-69 El Camino - Block letters w/ bowtie
FMEC0002001(C)

1968-69 El Camino - Block letters w/ SS
FMEC0002003(C)

1968-72 SS - SS 396
FMSS0004007(C)

1970 El Camino - Block letters w/ bowtie
FMEC0002002(C)

1970-72 El Camino - Block letters w/ SS
FMEC0002004(C)

1970-72 SS - SS 454
FMSS0004005(C)

1971-72 El Camino - Block letters w/ bowtie
FMEC0002005(C)

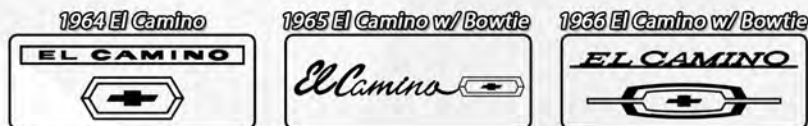



NOW AVAILABLE...

**2010-15
CHEVROLET CAMARO**

CAMARO

**CAMARO
RS**

**CAMARO
SS**

**CAMARO
Z/28**

**ZL1
CAMARO**

gm RESTORATION



1-833-700-3539

WWW.FLEXTREADMATS.COM

FLEXTREAD

FLEXTREAD

**2014-24
SILVERADO/SIERRA
FLOOR MATS**



NOW AVAILABLE FROM FLEXTREAD

**2015-22
COLORADO/CANYON
FLOOR MATS**



833-700-3539

WWW.FLEXTREAMATS.COM

FLEX TREAD®

YOU ASK FOR IT...WE DELIVERED!!

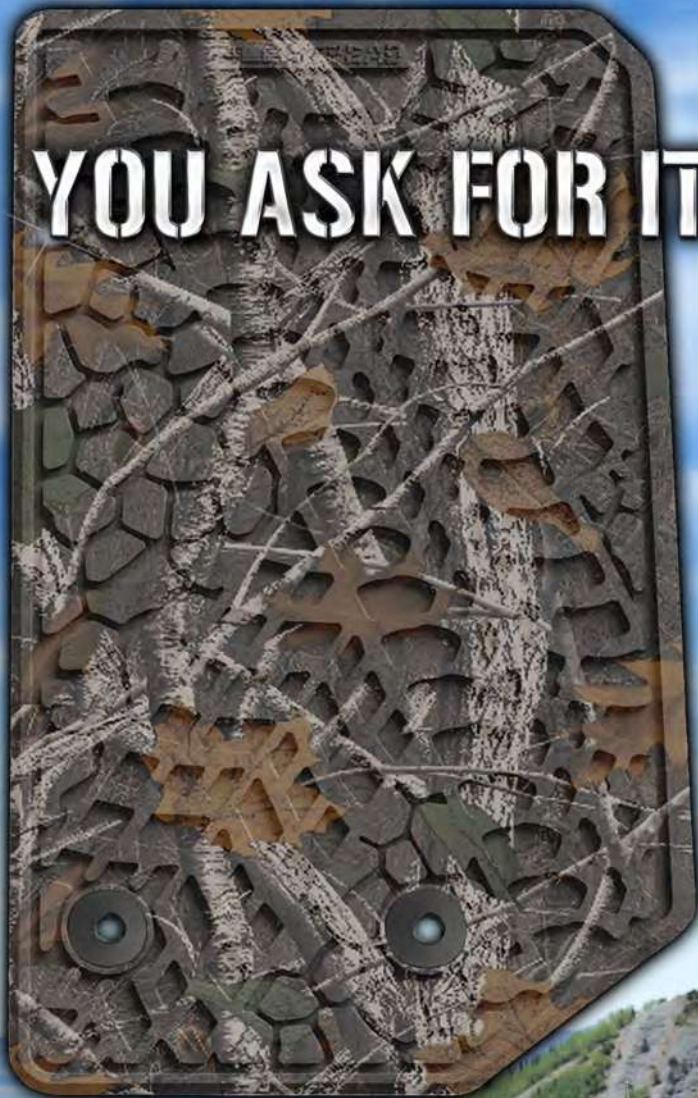

YOU ASK FOR IT...WE DELIVERED!!



Flexthead is providing the most innovative
molded floormats in the industry
RIGHT HERE AT HOME!
All products are 100% assembled, designed
and made in the U.S.A.





THE NEXT GENERATION IN FLOORMATS

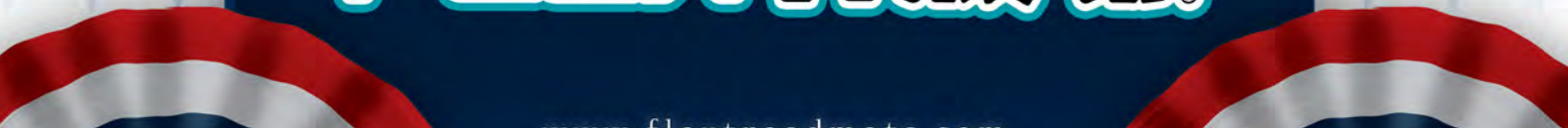

FLEXTREAD®





DASHES, CONSOLES AND ACCESORIES

 facebook.com/legendaryautointeriors
 twitter.com/legendaryautoin

 www.legendaryautointeriors.com
 instagram.com/legendaryautointeriorsltd
 youtube.com/user/legendaryauto

VINYL WRAPPED DASH PADS

These vinyl wrapped dash pads feature proper reproduction and the correct grain for 1964-1972 models. These are the closest to factory original dash pads available on the market. A rustproof rigid fiberglass inner-structure allows for a much better fit and easier damage free installation. Available in all factory colors. Mounting hardware included. Please specify color at time of order.



1964 Chevelle, Malibu & El Camino

DP64GHE01 (1964 Black).....	\$399.00/ea.
DP64GHE03 (1964 Red).....	\$399.00/ea.
DP64GHE04 (1964 Turquoise).....	\$399.00/ea.
DP64GHE18 (1964 Light Blue).....	\$399.00/ea.
DP64GHE26 (1964 Saddle).....	\$399.00/ea.
DP64GHE34 (1964 Fawn).....	\$399.00/ea.

1965 Chevelle, Malibu & El Camino

DP65GHE01 (1965 Black).....	\$399.00/ea.
DP65GHE03 (1965 Red).....	\$399.00/ea.
DP65GHE04 (1965 Turquoise).....	\$399.00/ea.
DP65GHE07 (1965 Dark Blue).....	\$399.00/ea.
DP65GHE18 (1965 Light Blue).....	\$399.00/ea.
DP65GHE34 (1965 Fawn).....	\$399.00/ea.
DP65GHE47 (1965 Dark Fawn).....	\$399.00/ea.

1966 Chevelle, Malibu & El Camino

DP66GHE01 (1966 Black).....	\$399.00/ea.
DP66GHE03 (1966 Red).....	\$399.00/ea.
DP66GHE04 (1966 Turquoise).....	\$399.00/ea.
DP66GHE10 (1966 Bright Blue).....	\$399.00/ea.
DP66GHE18 (1966 Light Blue).....	\$399.00/ea.
DP66GHE28 (1966 Bronze).....	\$399.00/ea.
DP66GHE47 (1966 Dark Fawn).....	\$399.00/ea.

1967 Chevelle, Malibu & El Camino

DP67GHE01 (1967 Black).....	\$399.00/ea.
DP67GHE03 (1967 Red).....	\$399.00/ea.
DP67GHE04 (1967 Turquoise).....	\$399.00/ea.
DP67GHE10 (1967 Bright Blue).....	\$399.00/ea.
DP67GHE18 (1967 Light Blue).....	\$399.00/ea.
DP67GHE32 (1967 Gold).....	\$399.00/ea.

1968-69 Chevelle, Malibu & El Camino

DP68GHE01 (68-69 Black).....	\$299.00/ea.
DP68GHE03 (68-69 Red).....	\$299.00/ea.
DP68GHE07 (68-69 Dark Blue).....	\$299.00/ea.
DP68GHE11 (68-69 Medium Blue).....	\$299.00/ea.
DP68GHE13 (68-69 Dark Green).....	\$299.00/ea.
DP68GHE14 (68-69 Light Green).....	\$299.00/ea.
DP68GHE18 (68-69 Light Blue).....	\$299.00/ea.
DP68GHE27 (68-69 Light Saddle).....	\$299.00/ea.
DP68GHE35 (68-69 Dark Red).....	\$299.00/ea.
DP68GHE46 (68-69 Ivy Gold).....	\$299.00/ea.

1970-1972 Chevelle, Malibu & El Camino With Center Speaker

DP70GHE01 (70-72 Black).....	\$529.00/ea.
DP70GHE03 (1970 Red).....	\$529.00/ea.
DP70GHE07 (70-72 Dark Blue).....	\$529.00/ea.
DP70GHE11 (1970 Medium Blue).....	\$529.00/ea.
DP70GHE12 (1971 Medium Blue).....	\$529.00/ea.
DP70GHE13 (1970 Dark Green).....	\$529.00/ea.
DP70GHE14 (1972 Green).....	\$529.00/ea.
DP70GHE27 (70-72 Light Saddle).....	\$529.00/ea.
With Speakers	
DP70GHE01W (70-72 Black).....	\$529.00/ea.
DP70GHE03W (1970 Red).....	\$529.00/ea.
DP70GHE07W (70-72 Dark Blue).....	\$529.00/ea.
DP70GHE11W (1970 Medium Blue).....	\$529.00/ea.
DP70GHE12W (1971 Medium Blue).....	\$529.00/ea.
DP70GHE13W (1970 Dark Green).....	\$529.00/ea.
DP70GHE14W (1972 Green).....	\$529.00/ea.
DP70GHE27W (70-72 Light Saddle).....	\$529.00/ea.

FIREWALL STEERING COLUMN COVER

Made of ABS plastic, this cover mounts where the steering column meets the firewall holding the carpet in place around the base of the steering column. Mounting hardware included.



1964-66 Chevelle, Malibu & El Camino
TA64GA-COVER (shown bottom).....\$59.00/ea.



1967 Chevelle, Malibu & El Camino
TA67GA-COVER (shown bottom).....\$59.00/ea.



1968-72 Chevelle, Malibu & El Camino
TA68GA-COVER (shown top).....\$49.00/ea.

66-72 CENTER CONSOLES

Replacement center consoles for 1966-72 automatic and 4-speed models. Hardware not included. Available in black only.



1966-67 Chevelle, Malibu & El Camino ^{OS1}
CS66GHS (4-speed) (shown middle).... \$259.00/ea.
CS66GHA (automatic) (shown top)..... \$ 89.00/ea.

1968-72 Chevelle, Malibu & El Camino
CS68GH (shown bottom)..... \$209.00/ea.
☞ Will work for both automatic and 4-speed models.

68-72 CENTER CONSOLE REAR LIGHT PANEL

Features original Madrid grain surface to match console exactly. This panel is injection molded plastic and includes an assembled lens and clips.



1968-72 Chevelle, Malibu & El Camino
CS68GH-RR.....\$39.00/ea.
☞ For both automatic and 4-speed models.



CONSOLE MOUNTING BRACKETS

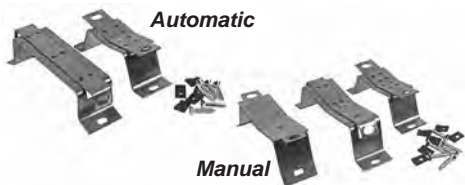

Exact reproduction of the factory console brackets, must be welded to floor.

1966-67 Chevelle, Malibu & El Camino NEW!!!
CS66GHE-BRACKETA (Automatic)\$19.00/ea.
CS66GHE-BRACKETM (Manual).....\$29.00/ea.

66-72 CONSOLE SHIFTER INSERTS

Manufactured to exact factory specifications. These automatic transmission shifter inserts are as original in fit and appearance.



1966-67 Chevelle, Malibu & El Camino
CS66GHA-INSERT (shown) (left)\$49.00/ea.
1968-72 Chevelle, Malibu & El Camino
CS68GHA-INSERT (right).....\$99.00/ea.

66-72 CONSOLE SHIFTER SLIDES



1966-67 Chevelle, Malibu & El Camino
CS66GHA-SLIDE (shown) (left).....\$10.00/ea.
1968-72 Chevelle, Malibu & El Camino
CS68GHA-SLIDE (right)\$19.00/ea.

GLOVEBOX EMBLEMS



Detailed, chrome plated and painted to perfection. These replacements are the highest quality in the industry.

1964 El Camino NEW!!!
GB64GE-EMBLEM\$29.00/ea.
1965 El Camino (shown) NEW!!!
GB65GE-EMBLEM\$29.00/ea.

GLOVEBOX LINERS

Glovebox liners are die-cut and pre-stapled with all mounting hardware attached for easy installation.



1964-65 Chevelle, Malibu & El Camino
GB64GHW/O (w/o A/C).....\$32.00/ea.
GB64GHW/A (with A/C).....\$32.00/ea.
1966-67 Chevelle, Malibu & El Camino
GB66GHW/O (w/o A/C).....\$43.00/ea.
GB66GHW/A (with A/C).....\$43.00/ea.
1968-69 Chevelle, Malibu & El Camino
GB68GHW/O (w/o A/C).....\$43.00/ea.

UNDERDASH INSULATION

Die-cut to original specifications, this insulation eliminates underdash noise and vibration.

1964-67 Chevelle, Malibu & El Camino
UD64GA\$17.00/kit
1968-72 Chevelle, Malibu & El Camino
UD68GA\$43.00/kit

66-72 CONSOLE TOP PLATES

Superbly reproduced center console top plates for 1966-72 models. Made for both automatic and 4-speed models. Console rear top plate (CS66GH-TPRR) is duplicated to exact original dimensions and flawlessly chromed.



1966-67 Chevelle, Malibu & El Camino
CS66GHS-TP (4-speed).....discontinued
CS66GHA-TP (automatic).....\$ 99.00/ea.

1966-67 Chevelle, Malibu & El Camino
CS66GH-TPRR (Rear top plate)\$105.00/ea.
 Will work for both automatic and 4-speed models.

1968-72 Chevelle, Malibu & El Camino
CS68GHS-TP (4-speed).....\$109.00/ea.
CS68GHA-TP (automatic).....\$109.00/ea.

66-72 CONSOLE LID COVERS

Console lids for models with a center console.

1966-67 lid is reproduced in correct diecast metal (black only) with authentic grain pattern while the 1968-72 lid is made of fine quality injection molded plastic. 1966-67 console lid hinge features stainless steel with properly tensioned springs.

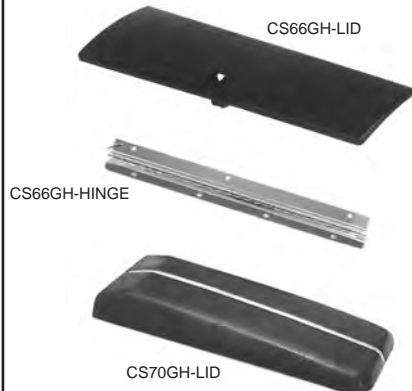

1966-67 Chevelle, Malibu & El Camino
CS66GH-LID\$89.00/ea.
CS66GH-HINGE.....\$41.25/ea.
 Will work for both automatic and 4-speed models.

1968 Chevelle, Malibu & El Camino
CS68GH-LID (1968).....\$79.00/ea.
CS69GH-LID (1969).....\$79.00/ea.
CS70GH-LID (1970-72).....\$99.00/ea.
 Will work for both automatic and 4-speed models.

Chevrolet

SHIFTER BOOTS



Reproduction 4-speed shifter boot for 1964-66 models without a console.

1964-66 Chevelle, Malibu & El Camino
TN64GH-L\$29.00/ea.



Reproduction 4-speed shifter boot for 1964-65 models with a console.

1964-65 Chevelle, Malibu & El Camino
TN64GH-U\$10.00/ea.



Reproduction 4-speed shifter boot for 1966-67 models with a console.

1966-67 Chevelle, Malibu & El Camino
TN66GH-U\$29.00/ea.



Shifter boots made for 1968-72 models with and without consoles. Upper boot fits console models while the lower boot mounts to the tunnel on models without a console.

1968-72 Chevelle, Malibu & El Camino
TN68GH-L (Lower) (Shown Left)\$29.00/ea.
TN68GH-U (Upper) (Shown Right)\$19.00/ea.

PEDAL PADS & BEZELS

Reproduction pedal pads and bezels for accelerators, brake/clutch and parking brake.

ACCELERATORS & BEZELS



1964-67 Chevelle, Malibu & El Camino
PB64GA-A (pad) (shown left)\$29.00/ea.
 ☞ This pad is the closest available to the original.

1968-72 Chevelle, Malibu & El Camino
PB68GHK-A (pad) (shown right)\$ 8.00/ea.
PB68GHK-ABEZ (bezel)\$11.00/ea.

4-SPEED CLUTCH /BRAKE PADS & BEZELS



1964-72 Chevelle, Malibu & El Camino
PB64GA4SP-B/C (pad)\$6.00/ea.
PB64GA4SP-B/CBEZ (bezel)\$10.00/pr.

1967-72 Chevelle, Malibu & El Camino
PB67GA4SP-B/C (pad) (w/ Disc Brakes) ..\$17.00/ea.
 ☞ Brake only. For clutch pad use part #PB64GA4SP-B/C.

AUTOMATIC BRAKE PADS & BEZELS



1964-72 Chevelle, Malibu & El Camino
PB64GA-B (pad)\$15.00/ea.
PB64GG-BBEZ (bezel)\$17.00/ea.



1967-72 Chevelle, Malibu & El Camino
PB67GA-B (pad) (w/ Disc Brakes)\$15.00/ea.

PARKING BRAKE PADS



1964-72 Chevelle, Malibu & El Camino
PB64GA-P (pad)\$6.00/ea.
PB64GA-PBEZ (bezel)\$6.00/ea.

GAS PEDAL SPRING



Correct tension spring for all 68-72 A-Body applications.

1968-72 Chevelle, Malibu & El Camino NEW!!!
PB68GA-SPRING \$7.00/ea.

GAS PEDAL ROD PIN



Dimensionally accurate to the original with the same fit and function.

1968-72 Chevelle, Malibu & El Camino NEW!!!
PB68GA-RODPIN \$7.00/ea.

STEERING COLUMN COVERS



Screws to the bottom of the dash to cover the steering column. Made of rigid ABS plastic with the correct grain.

1967 Chevelle, Malibu & El Camino NEW!!!
TA67GHE-COVER\$59.00/ea.

1968 Chevelle, Malibu & El Camino NEW!!!
TA68GHE-COVER\$79.00/ea.

1969 Chevelle, Malibu & El Camino NEW!!!
TA69GHE-COVER\$49.00/ea.

DASH STEERING COLUMN SEAL

Precision die-cut gasket seals the steering column at the firewall.





1964-67 Chevelle, Malibu & El Camino
GK64GA (shown right)\$17.00/ea.



1968-72 Chevelle, Malibu & El Camino
GK68GA (shown left)\$17.00/ea.





HEADLINERS AND TRIM ACCESORIES

 facebook.com/legendaryautointeriors
 twitter.com/legendaryautoin

 www.legendaryautointeriors.com
 instagram.com/legendaryautointeriorsltd
 youtube.com/user/legendaryauto

Headliner Grains and Colors

Legendary Auto Interiors headliners are manufactured to original specifications and are available in a variety of colors in Perforated or Non-Perforated pattern. Each headliner is assembled with heavy-duty stitching.

If your year/model is not listed please contact our sales department for assistance on availability. Please specify perforated or non-perforated at time of order. Sample approval is highly recommended for colors other than black.

STANDARD *style*

Basketweave (1964-65)



Linedot (1967)



OEM *style*

Linedot (1967)



Ariel (1964)



Tier (1965-67)



Ribbed Bedford (1968-69)



Perforated (1970-72)



HEADLINERS

1964 Chevelle & Malibu

(Ariel Grain)

HL64GH01A (black).....	\$169.00/ea.
HL64GH02A (white).....	\$169.00/ea.
HL64GH58A (powder blue).....	\$169.00/ea.
HL64GH98A (brown).....	\$169.00/ea.

1964 Custom El Camino

(Ariel Grain)

HL64GE02A1 (white) (2-bow).....	\$139.00/ea.
HL64GE02A2 (white) (3-bow).....	\$139.00/ea.

1964-65 Chevelle 300 & 300 Deluxe

(Basketweave Grain)

HL64GH02B (white).....	\$169.00/ea.
HL64GH04B (aqua).....	\$169.00/ea.
HL64GH34B (fawn).....	\$169.00/ea.
HL64GH58B (powder blue).....	\$169.00/ea.

1964-65 El Camino

(Basketweave Grain)

HL64GE02B1 (white) (2-bow).....	\$139.00/ea.
HL64GE02B2 (white) (3-bow).....	\$139.00/ea.
HL64GE04B1 (aqua) (2-bow).....	\$139.00/ea.
HL64GE04B2 (aqua) (3-bow).....	\$139.00/ea.
HL64GE34B1 (fawn) (2-bow).....	\$139.00/ea.
HL64GE34B2 (fawn) (3-bow).....	\$139.00/ea.

1965 Chevelle & Malibu

(Tier Grain)

HL65GH01T (black).....	\$169.00/ea.
HL65GH02T (white).....	\$169.00/ea.
HL65GH58T (powder blue).....	\$169.00/ea.

1965 Custom El Camino

(Tier Grain)

HL65GE02T1 (white) (2-bow).....	\$169.00/ea.
HL65GE02T2 (white) (3-bow).....	\$169.00/ea.

1966 Chevelle & Malibu (Hardtop)

(Tier Grain)

HL66GH01T1 (black).....	\$169.00/ea.
HL66GH02T1 (white).....	\$169.00/ea.
HL66GH03T1 (red).....	\$169.00/ea.
HL66GH10T1 (bright blue).....	\$169.00/ea.
HL66GH11T1 (medium blue).....	\$169.00/ea.
HL66GH50T1 (turquoise).....	\$169.00/ea.

☞ Early 1966 models have a small sail panel board.

1966 Chevelle & Malibu (Hardtop)

(Tier Grain)

HL66GH01T2 (black).....	\$169.00/ea.
HL66GH02T2 (white).....	\$169.00/ea.
HL66GH03T2 (red).....	\$169.00/ea.
HL66GH10T2 (bright blue).....	\$169.00/ea.
HL66GH11T2 (medium blue).....	\$169.00/ea.
HL66GH50T2 (turquoise).....	\$169.00/ea.

☞ Late 1966 models have a full sail panel board.

1966 El Camino

(Tier Grain)

HL66GE01T2 (black) (3-bow).....	\$139.00/ea.
HL66GE03T2 (red) (3-bow).....	\$139.00/ea.
HL66GE11T2 (medium blue) (3-bow).....	\$139.00/ea.

1967 Chevelle & Malibu

(Linedot Grain)

HL67GH01L (black).....	\$169.00/ea.
HL67GH03L (red).....	\$169.00/ea.
HL67GH10L (bright blue).....	\$169.00/ea.
HL67GH11L (medium blue).....	\$169.00/ea.
HL67GH133L (gold).....	\$209.00/ea.
HL67GH50L (turquoise).....	\$169.00/ea.

1967 El Camino

(Linedot Grain)

HL67GE01L2 (black) (3-bow).....	\$139.00/ea.
HL67GE03L2 (red) (3-bow).....	\$139.00/ea.
HL67GE11L2 (medium blue) (3-bow).....	\$139.00/ea.
HL67GE133L2 (gold) (3-bow).....	\$179.00/ea.

1968 Chevelle & Malibu

(Ribbed Grain)

HL68GH501R (black) (5-bow).....	\$169.00/ea.
HL68GH601R (black) (6-bow).....	\$169.00/ea.
HL68GH502R (white) (5-bow).....	\$169.00/ea.
HL68GH602R (white) (6-bow).....	\$169.00/ea.
HL68GH503R (red) (5-bow).....	\$169.00/ea.
HL68GH603R (red) (6-bow).....	\$169.00/ea.
HL68GH511R (med blue) (5-bow).....	\$169.00/ea.
HL68GH611R (med blue) (6-bow).....	\$169.00/ea.
HL68GH518R (light blue) (5-bow).....	\$169.00/ea.
HL68GH618R (light blue) (6-bow).....	\$169.00/ea.
HL68GH546R (ivy gold) (5-bow).....	\$169.00/ea.
HL68GH646R (ivy gold) (6-bow).....	\$169.00/ea.

1968-69 El Camino

(Ribbed Grain)

HL68GE01R (black).....	\$139.00/ea.
HL68GE07R (dark blue).....	\$139.00/ea.
HL68GE11R (medium blue).....	\$139.00/ea.
HL68GE98R (brown).....	\$139.00/ea.

1969 Chevelle & Malibu

(Ribbed Grain)

HL69GH01R (black).....	\$169.00/ea.
HL69GH02R (white).....	\$169.00/ea.
HL69GH03R (red).....	\$169.00/ea.
HL69GH03R (red).....	\$169.00/ea.
HL69GH07R (dark blue).....	\$169.00/ea.
HL69GH13R (dark green).....	\$169.00/ea.

1970-72 Chevelle & Malibu

(Perforated Grain)

HL70GH01P (black).....	\$169.00/ea.
HL70GH02P (white).....	\$169.00/ea.
HL70GH03P (red).....	\$169.00/ea.
HL70GH07P (dark blue).....	\$169.00/ea.
HL70GH13P (dark green).....	\$169.00/ea.
HL70GH17P (buckskin).....	\$169.00/ea.
HL70GH38P (sandalwood).....	\$169.00/ea.
HL70GH98P (brown).....	\$169.00/ea.

1970-72 El Camino

(Perforated Grain)

HL70GE01P (black).....	\$139.00/ea.
HL70GE07P (dark blue).....	\$139.00/ea.
HL70GE11P (medium blue).....	\$139.00/ea.
HL70GE17P (buckskin).....	\$139.00/ea.
HL70GE38P (sandalwood).....	\$139.00/ea.
HL70GE98P (brown).....	\$139.00/ea.

NOS HEADLINERS

Some colors and grains are not reproduced in today's market. We offer NOS (New Old Stock) headliners for those extremely limited items. Many years and models are available. Please call for assistance.

HLNOS \$935.00/ea.
☞ Please specify year and model.

HEADLINER INSULATION

Headliner insulation kits glue directly to the roof and provide protection from noise, heat and cold infiltration.



1964-67 Chevelle & Malibu

HL64GA (4pc.) \$32.00/ea.

1968-72 Chevelle & Malibu

HL68GA (4pc.) \$32.00/ea.

HEADLINER BOW RETAINER CLIPS

Plastic retainer clips slide onto the edge of the inner roof-rail and help secure the headliner bows during installation of headliner.



1964-72 Chevelle & Malibu

HLGA-CLIPS4 (Pkg/4) \$21.00/pk.

1968-72 Chevelle & Malibu

HLGA-CLIPS6 (Pkg/6) \$29.00/pk.

DOME LIGHT LENS & BEZELS

Replacement dome light lenses and bezels for 1964-72 models.



1964-67 Chevelle & Malibu

LL64GH (Lens only).....\$6.00/ea.
LL64GH-BEZ (Bezel only).....\$11.00/ea.



1964-67 El Camino

LL64GE (Lens only).....\$15.00/ea.
LL64GE-BEZ (Bezel only).....\$19.00/ea.



1968-70 Chevelle & Malibu

LL68GA (Lens only).....\$15.00/ea.
LL68GA-BEZ (Bezel only).....\$29.00/ea.



1968-72 El Camino

LL68GE (Lens only).....\$15.00/ea.
LL68GE-BEZ (Bezel only).....\$19.00/ea.



1971-72 Chevelle & Malibu

LL69GA (Lens only).....\$10.00/ea.
LL69GA-BEZ (Bezel only).....\$15.00/ea.

Chevrolet

CONVERTIBLE SUNVISOR BRACKETS



Diecast, high-strength, chromed to perfection. Guaranteed in fit and function to be identical to the original GM part.

1964-65 Chevelle, Malibu & El Camino NEW!!!
SV64GA-BRACKET..... \$139.00/pr.

1966-67 Chevelle, Malibu & El Camino NEW!!!
SV66GA-BRACKET..... \$99.00/pr.



1968-72 Chevelle, Malibu & El Camino NEW!!!
SV68GA-BRACKET..... \$99.00/pr.

1964-72 HARDTOP SUNVISOR SUPPORTS

Chrome sunvisor support with correct tension screw to insure an accurate fit for original and reproduction sunvisors.



1964-72 Chevelle, Malibu & El Camino
SV64GA-SUPPORT..... \$32.00/ea.

SUNVISOR TIP & BUSHING KIT



Sunvisor tips with sleeves for 1964-72 models with double pin sunvisors and a center mounted sunvisor retainer over the rearview mirror. Set includes 2 rubber tips and 2 plastic sleeves.

SVTIP-KIT \$10.00/kit

UPPER WINDSHIELD TRIM

Interior upper windshield trim strip mounts at the top of the windshield and helps hold the headliner in place. Available in black only, paint as required.

1964-67 Chevelle, Malibu & El Camino
WT64GA..... \$27.00/ea.

PILLAR POST MOLDINGS

These urethane-molded, not foam filled pillar moldings feature authentic grain and texture as the originals. Available in Black only, but can be painted to match interior colors.



1968-69 Chevelle, Malibu & El Camino
PP68GA-CPE01 (Black) (Coupe)..... \$129.00/pr.

1968-72 Chevelle & Malibu
PP68GA-CONV01 (Black) (Conv.).... \$129.00/pr.

REAR WINDOW TRIM

Interior rear window trim made of molded plastic features all the correct contours as the originals. This trim snaps into place around the rear window holding the headliner and sail panel boards in place along with providing a finished look. Available in black only, paint as required.

1964-65 Chevelle & Malibu (Hardtop)
RT64GH07 (Complete 7 pc. set)..... \$129.00/set
RT64GH03 (Upper & side pcs. only) .. \$99.00/set
RT64GH-UPPER (Upper corners only) . \$29.00/pr.
RT64GH-LOWER (Lower corners only) \$49.00/pr.

1966-67 Chevelle & Malibu (Hardtop)
RT66GA03 (Complete 3 pc. set)..... \$99.00/set
RT66GA-CTRCAP (Center cap only) \$49.00/ea.

SAIL PANEL BOARDS

Die-cut to original size and shape, these reproduction sail panel boards replace warped or water damaged originals. These panels are located between the package tray and headliner and come pre-covered with headliner material.

NOTE: Due to a special proprietary process used in-house, we guarantee the vinyl WILL NOT bubble or delaminate from the board.

1964 Chevelle/Malibu (Ariel Grain)
SB64GH01A (black)..... \$97.00/pr.
SB64GH02A (white)..... \$97.00/pr.
SB64GH58A (powder blue)..... \$97.00/pr.
SB64GH98A (brown)..... \$97.00/pr.

1964 Custom El Camino (Ariel Grain)
SB64GE02A (white)..... \$80.00/pr.

1964-65 Chevelle 300 (Basketweave Grain)
SB64GH02B (white)..... \$66.00/pr.
SB64GH04B (aqua)..... \$66.00/pr.
SB64GH34B (fawn)..... \$66.00/pr.
SB64GH58B (powder blue)..... \$66.00/pr.

1964-65 El Camino (Basketweave Grain)
SB64GE02B (white)..... \$55.00/pr.
SB64GE04B (aqua)..... \$55.00/pr.
SB64GE34B (fawn)..... \$55.00/pr.

1965 Chevelle/Malibu (Tier Grain)
SB65GH01T (black)..... \$66.00/pr.
SB65GH02T (white)..... \$66.00/pr.
SB65GH58T (powder blue)..... \$66.00/pr.

1965 Custom El Camino (Tier Grain)
SB65GE02T (white)..... \$55.00/pr.

1966 El Camino (Tier Grain)
SB66GE01T (black)..... \$55.00/pr.
SB66GE03T (red)..... \$55.00/pr.
SB66GE11T (medium blue)..... \$55.00/pr.

1967 Chevelle (Linedot Grain)
SB67GH01L (black)..... \$66.00/pr.
SB67GH03L (red)..... \$66.00/pr.
SB67GH10L (bright blue)..... \$66.00/pr.
SB67GH11L (medium blue)..... \$66.00/pr.
SB67GH133L (gold)..... \$97.00/pr.
SB67GH50L (turquoise)..... \$66.00/pr.

1967 El Camino (Linedot Grain)

SB67GE01L (black)..... \$55.00/pr.
SB67GE03L (red)..... \$55.00/pr.
SB67GE11L (medium blue)..... \$55.00/pr.
SB67GE133L (gold)..... \$80.00/pr.

1968-69 Chevelle & Malibu (Ribbed Grain)

SB68GH01R (black)..... \$66.00/pr.
SB68GH02R (white)..... \$66.00/pr.
SB68GH03R (red)..... \$66.00/pr.
SB68GH07R (dark blue)..... \$66.00/pr.
SB68GH11R (medium blue)..... \$66.00/pr.
SB68GH13R (dark green)..... \$66.00/pr.
SB68GH18R (light blue)..... \$66.00/pr.
SB68GH46R (ivy gold)..... \$66.00/pr.

1968-69 El Camino (Ribbed Grain)

SB68GE01R (black)..... \$55.00/pr.
SB68GE07R (dark blue)..... \$55.00/pr.
SB68GE11R (medium blue)..... \$55.00/pr.
SB68GE98R (brown)..... \$55.00/pr.

1970-72 Chevelle & Malibu (Perforated Grain)

SB70GH01P (black)..... \$66.00/pr.
SB70GH02P (white)..... \$66.00/pr.
SB70GH03P (red)..... \$66.00/pr.
SB70GH07P (dark blue)..... \$66.00/pr.
SB70GH13P (dark green)..... \$66.00/pr.
SB70GH17P (buckskin)..... \$66.00/pr.
SB70GH38P (sandalwood)..... \$66.00/pr.
SB70GH98P (brown)..... \$66.00/pr.

1970-72 El Camino (Perforated Grain)

SB70GE01P (black)..... \$55.00/pr.
SB70GE07P (dark blue)..... \$55.00/pr.
SB70GE11P (medium blue)..... \$55.00/pr.
SB70GE17P (buckskin)..... \$55.00/pr.
SB70GE38P (sandalwood)..... \$55.00/pr.
SB70GE98P (brown)..... \$55.00/pr.

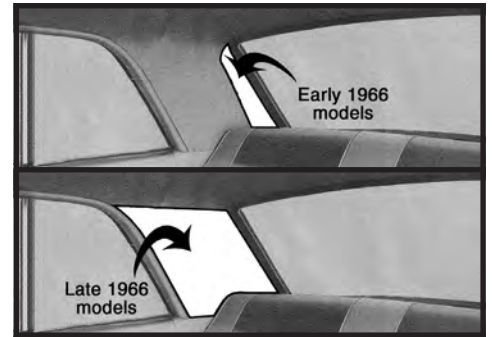

1966 Chevelle & Malibu (Early production) (Tier Grain)

SB66GH01T1 (black)..... \$55.00/pr.
SB66GH02T1 (white)..... \$55.00/pr.
SB66GH03T1 (red)..... \$55.00/pr.
SB66GH10T1 (bright blue)..... \$55.00/pr.
SB66GH11T1 (medium blue)..... \$55.00/pr.
SB66GH50T1 (turquoise)..... \$55.00/pr.

☞ Early 1966 models have a small sail panel.

1966 Chevelle & Malibu (Late production) (Tier Grain)

SB66GH01T2 (black)..... \$66.00/pr.
SB66GH02T2 (white)..... \$66.00/pr.
SB66GH03T2 (red)..... \$66.00/pr.
SB66GH10T2 (bright blue)..... \$66.00/pr.
SB66GH11T2 (medium blue)..... \$66.00/pr.
SB66GH50T2 (turquoise)..... \$66.00/pr.

☞ Late 1966 models have a full sail panel board.



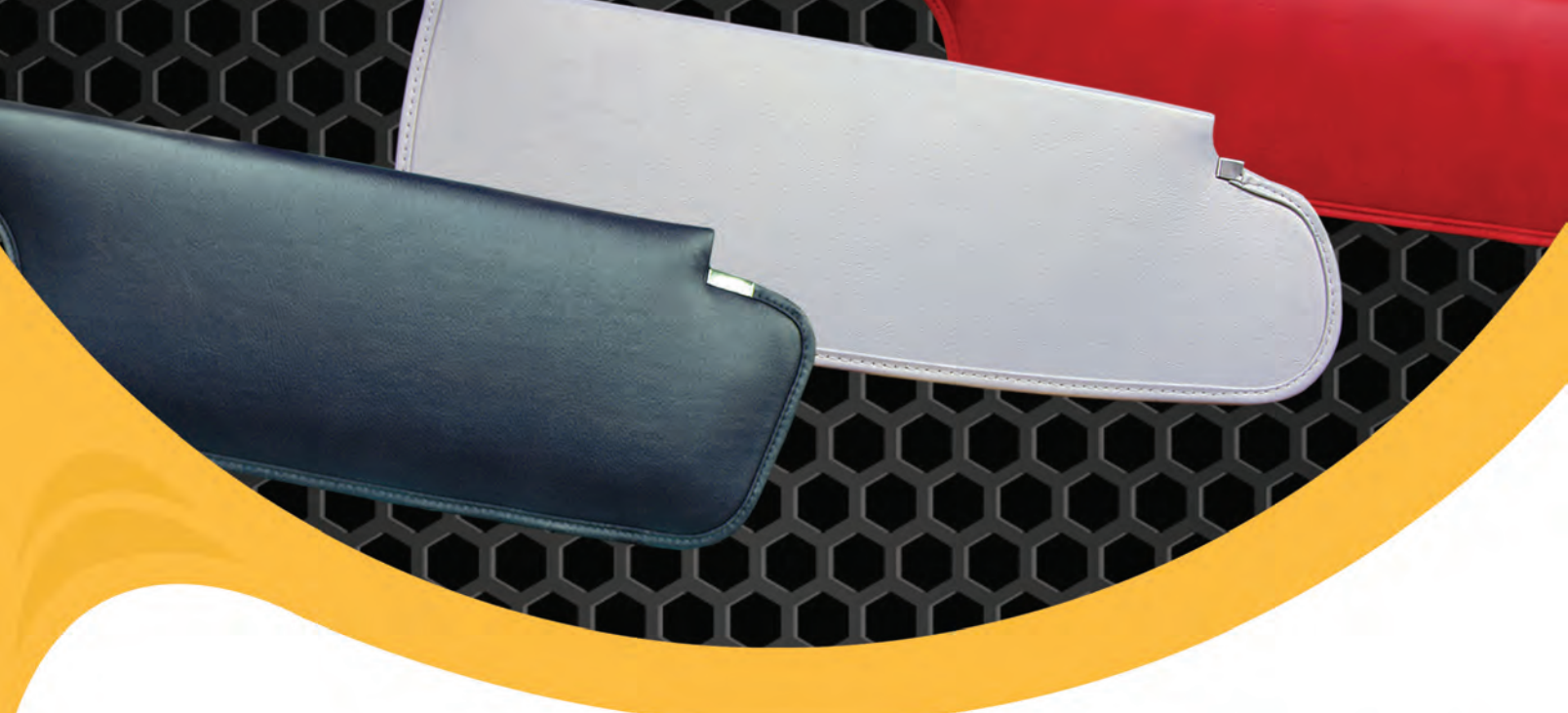

SUNVISORS

Original reproduction sunvisors are made with the correct grains and vinyl colors as applicable by year/make/model to compliment and match your Legendary interior. Superior materials and technology with World Class craftsmanship create the highest quality sunvisors available. Original mounting hardware and metal rod must be reused. Please specify hardtop or convertible and color at time of order.

- Factory correct size, shape, colors and grains by year, make and model
- Original fit and appearance
- Custom colors and grains available
- Limited Lifetime Warranty (*First and only in the industry!!!*)
- Correct multi layer construction applicable by year, make and model
- Available with or without cut-outs for driver and passenger mirror options



Correct multi layer construction & shape applicable by year, make, model & body style

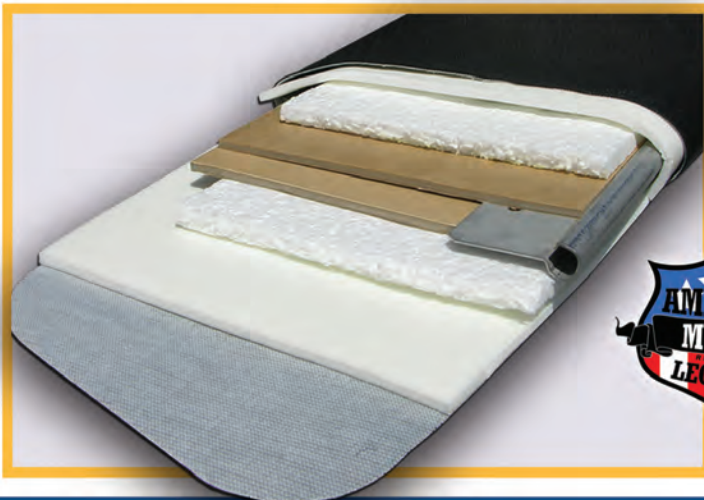

SUNVISORS

HARDTOP SUNVISORS

1964 Chevelle Malibu & Custom El Camino (Ariel Grain)
 SV64GHE01A-PA (Black) \$233.00/pr.
 SV64GHE02A-PA (White) \$233.00/pr.

1964-65 Chevelle 300, 300 Deluxe & El Camino (Basket Weave Grain)
 SV64GHE02B-PA (White) \$168.00/pr.
 SV64GHE04B-PA (Aqua) \$168.00/pr.
 SV64GHE34B-PA (Fawn) \$168.00/pr.

1965 Chevelle Malibu & Custom El Camino (Tier Grain)
 SV65GHE01T-PA (Black) \$168.00/pr.
 SV65GHE02T-PA (White) \$168.00/pr.
 SV65GHE58T-PA (Powder Blue) .. \$168.00/pr.

1966 Chevelle Malibu & El Camino (Tier Grain)
 SV66GHE01T-PA (Black) \$168.00/pr.
 SV66GHE02T-PA (White) \$168.00/pr.
 SV66GHE03T-PA (Red) \$168.00/pr.
 SV66GHE10T-PA (Bright Blue) \$168.00/pr.
 SV66GHE11T-PA (Light Blue) \$168.00/pr.
 SV66GHE50T-PA (Turquoise) \$168.00/pr.

1967 Chevelle Malibu & El Camino (Line Dot Grain)
 SV67GHE01L-PA (Black) \$168.00/pr.
 SV67GHE03L-PA (Black) \$168.00/pr.
 SV67GHE10L-PA (Bright Blue) \$168.00/pr.
 SV67GHE11L-PA (Medium Blue) .. \$168.00/pr.
 SV67GHE13L-PA (Gold) \$168.00/pr.
 SV67GHE50L-PA (Turquoise) \$168.00/pr.

1968 Chevelle Malibu & El Camino (Ribbed Grain)
 SV68GHE01R-PA (Black) \$168.00/pr.
 SV68GHE02R-PA (White) \$168.00/pr.
 SV68GHE03R-PA (Red) \$168.00/pr.
 SV68GHE11R-PA (Medium Blue) .. \$168.00/pr.
 SV68GHE18R-PA (Light Blue) \$168.00/pr.

1969 Chevelle Malibu & El Camino (Ribbed Grain)
 SV69GHE01R-PA (Black) \$168.00/pr.
 SV69GHE02R-PA (White) \$168.00/pr.
 SV69GHE03R-PA (Red) \$168.00/pr.
 SV69GHE07R-PA (Dark Blue) \$168.00/pr.
 SV69GHE13R-PA (Green) \$168.00/pr.
 SV69GHE98R-PA (Brown) \$168.00/pr.

1970 Chevelle Malibu & El Camino (Perforated Grain)
 SV70GHE01P-PA (Black) \$168.00/pr.
 SV70GHE02P-PA (White) \$168.00/pr.
 SV70GHE03P-PA (Red) \$168.00/pr.
 SV70GHE11P-PA (Medium Blue) .. \$168.00/pr.
 SV70GHE13P-PA (Dark Green) \$168.00/pr.
 SV70GHE17P-PA (Buckskin) \$168.00/pr.

1971-72 Chevelle Malibu & El Camino (Perforated Grain)
 SV71GHE01P-PA (Black) \$168.00/pr.
 SV71GHE02P-PA (White) \$168.00/pr.
 SV71GHE07P-PA (Dark Blue) \$168.00/pr.
 SV71GHE13P-PA (Dark Green) \$168.00/pr.
 SV71GHE38P-PA (Sandlewood) ... \$168.00/pr.
 SV71GHE98P-PA (Brown) \$168.00/pr.

CONVERTIBLE SUNVISORS

1964 Chevelle & Malibu (Seville Grain)
 SV64GA100G-PA (Black) \$168.00/pr.
 SV64GA220G-PA (Frost White) \$168.00/pr.
 SV64GA325G-PA (Metallic Blue) \$168.00/pr.
 SV64GA231G-PA (Fawn) \$279.00/pr. (L1)

1965 Chevelle & Malibu (Madrid Grain)
 SV65GA100G-PA (Black) \$168.00/pr.
 SV65GA140G-PA (Slate) \$279.00/pr. (L1)
 SV65GA220G-PA (Frost White) \$168.00/pr.
 SV65GA232G-PA (Fawn) \$279.00/pr. (L1)
 SV65GA235G-PA (Fawn) \$168.00/pr.
 SV65GA325G-PA (Lt. Met. Blue) \$168.00/pr.
 SV65GA343G-PA (Dk. Met. Blue) \$168.00/pr.
 SV65GA420G-PA (Met. Turquoise) ... \$168.00/pr.
 SV65GA501G-PA (Red) \$168.00/pr.
 SV65GA642G-PA (Gold) \$176.00/pr. (L4)
 SV65GA679G-PA (Saddle) \$279.00/pr. (L1)

1966 Chevelle & Malibu (Madrid Grain)
 SV66GA100G-PA (Black) \$168.00/pr.
 SV66GA220G-PA (Frost White) \$168.00/pr.
 SV66GA235G-PA (Fawn) \$168.00/pr.
 SV66GA325G-PA (Lt. Met. Blue) \$168.00/pr.
 SV66GA338G-PA (Bright Blue) \$168.00/pr.
 SV66GA420G-PA (Metallic Aqua) \$168.00/pr.
 SV66GA511G-PA (Red) \$168.00/pr.
 SV66GA526G-PA (Bronze) \$279.00/pr. (L1)

1967 Chevelle & Malibu (Madrid Grain)
 SV66GA100G-PA (Black) \$168.00/pr.
 SV66GA325G-PA (Lt. Met. Blue) \$168.00/pr.
 SV66GA338G-PA (Bright Blue) \$168.00/pr.
 SV66GA424G-PA (Met. Turq) \$176.00/pr. (L4)
 SV66GA501G-PA (Red) \$168.00/pr.

1968 Chevelle & Malibu (Madrid Grain)
 SV68GA100G-PA (Black) \$168.00/pr.
 SV68GA204G-PA (Met. Parchment) ... \$168.00/pr.
 SV68GA333G-PA (Light Blue) \$176.00/pr. (L4)
 SV68GA501G-PA (Red) \$168.00/pr.
 SV68GA645G-PA (Willow Gold) .. \$176.00/pr. (L4)

1969 Chevelle & Malibu (Madrid Grain)
 SV69GA100G-PA (Black) \$168.00/pr.
 SV69GA239G-PA (Met. Parchment) .. \$168.00/pr.
 SV69GA369G-PA (Dark Met Blue) \$168.00/pr.
 SV69GA511G-PA (Red) \$168.00/pr.

1970 Chevelle & Malibu (Madrid Grain)
 SV70GA100G-PA (Black) \$168.00/pr.
 SV70GA202G-PA (Peal White) \$168.00/pr.
 SV70GA310G-PA (Lt. Met. Blue) \$168.00/pr.
 SV70GA513G-PA (Red) \$168.00/pr.
 SV70GA683G-PA (Saddle) \$168.00/pr.

CONVERTIBLE SUNVISORS CONT.

1971 Chevelle & Malibu (Madrid Grain)
 SV70GA100G-PA (Black) \$168.00/pr.
 SV70GA380G-PA (Blue) \$168.00/pr.
 SV70GA415G-PA (Jade Green) \$176.00/pr. (L4)
 SV70GA690G-PA (Saddle) \$168.00/pr.

1972 Chevelle & Malibu (Madrid Grain)
 SV70GA100G-PA (Black) \$168.00/pr.
 SV70GA230G-PA (White) \$168.00/pr.
 SV70GA465G-PA (Green) \$168.00/pr. (L4)



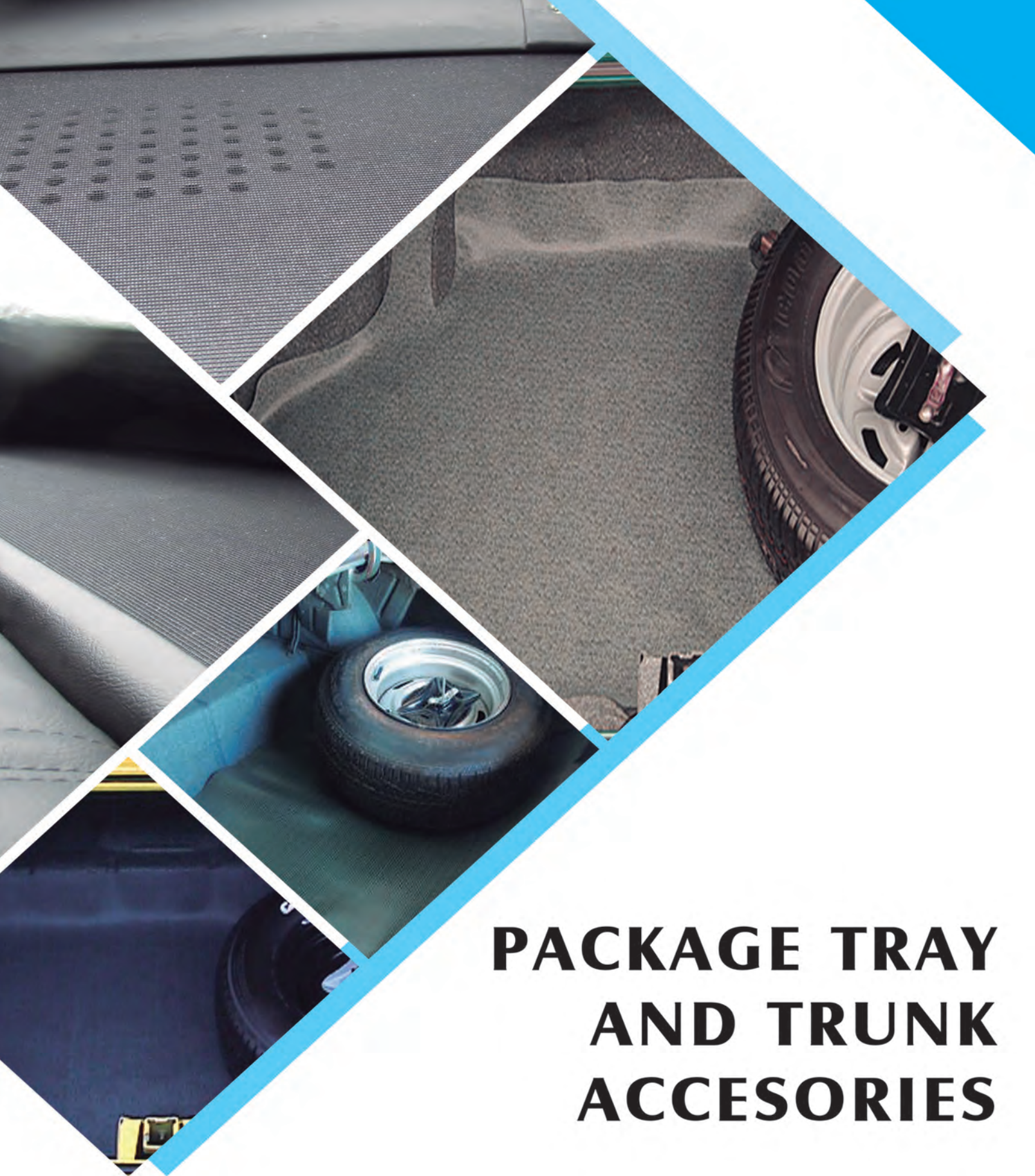



PACKAGE TRAY AND TRUNK ACCESORIES

 facebook.com/legendaryautointeriors

 twitter.com/legendaryautoin

 www.legendaryautointeriors.com

 instagram.com/legendaryautointeriorsltd

 youtube.com/user/legendaryauto

PACKAGE TRAYS AND JUTE INSULATION

Die-cut to original specifications, these reproductions of the original panels go between the top of the rear seat and the back window. Colors are year specific and are available with or without speaker grill cutouts. Die-cut jute insulation helps reduce the amount of noise and heat that would come from the trunk compartment.

PACKAGE TRAYS & JUTE INSULATION

1964 Chevelle & Malibu (Hardtop)

(Without Cuts)

PT64GH100GN (black)	\$79.00/ea.
PT64GH231GN (fawn)	\$79.00/ea.
PT64GH325GN (blue)	\$79.00/ea.
PT64GH419GN (aqua)	\$79.00/ea.
PT64GH508GN (red)	\$79.00/ea.
PT64GH656GN (dark brown)	\$79.00/ea.

(With Cuts)

PT64GH100G (black)	\$119.00/ea.
PT64GH231G (fawn)	\$119.00/ea.
PT64GH325G (blue)	\$119.00/ea.
PT64GH419G (aqua)	\$119.00/ea.
PT64GH508G (red)	\$119.00/ea.
PT64GH656G (dark brown)	\$119.00/ea.
PT64GHJ (jute insulation)	\$25.00/ea.

1965 Chevelle & Malibu (Hardtop)

(Without Cuts)

PT64GH100GN (black)	\$79.00/ea.
PT64GH232GN (fawn)	\$79.00/ea.
PT64GH235GN (fawn)	\$79.00/ea.
PT64GH325GN (blue)	\$79.00/ea.
PT64GH344GN (charcoal blue)	\$79.00/ea.
PT64GH420GN (aqua)	\$79.00/ea.
PT64GH501GN (red)	\$79.00/ea.
PT64GH679GN (dark brown)	\$79.00/ea.

(With Cuts)

PT64GH100G (black)	\$119.00/ea.
PT64GH232G (fawn)	\$119.00/ea.
PT64GH235G (fawn)	\$119.00/ea.
PT64GH325G (blue)	\$119.00/ea.
PT64GH344G (charcoal blue)	\$119.00/ea.
PT64GH420G (aqua)	\$119.00/ea.
PT64GH501G (red)	\$119.00/ea.
PT64GH679G (dark brown)	\$119.00/ea.
PT64GHJ (jute insulation)	\$25.00/ea.

1966 Chevelle & Malibu (Hardtop)

(Without Cuts)

PT66GH100GN (black)	\$79.00/ea.
PT66GH235GN (fawn)	\$79.00/ea.
PT66GH325GN (blue)	\$79.00/ea.
PT66GH338GN (bright blue)	\$79.00/ea.
PT66GH420GN (aqua)	\$79.00/ea.
PT66GH511GN (red)	\$79.00/ea.
PT66GH526GN (bronze)	\$79.00/ea.

(With Cuts)

PT66GH100G (black)	\$119.00/ea.
PT66GH235G (fawn)	\$119.00/ea.
PT66GH325G (blue)	\$119.00/ea.
PT66GH338G (bright blue)	\$119.00/ea.
PT66GH420G (aqua)	\$119.00/ea.
PT66GH511G (red)	\$119.00/ea.
PT66GH526G (bronze)	\$119.00/ea.
PT66GHJ (jute insulation)	\$25.00/ea.

1967 Chevelle & Malibu (Hardtop)*(Without Cuts)*

PT66GH100GN (black)	\$79.00/ea.
PT66GH325GN (blue)	\$79.00/ea.
PT66GH338GN (bright blue)	\$79.00/ea.
PT66GH424GN (met turquoise)	\$79.00/ea.
PT66GH501GN (red)	\$79.00/ea.

(With Cuts)

PT66GH100G (black)	\$119.00/ea.
PT66GH325G (blue)	\$119.00/ea.
PT66GH338G (bright blue)	\$119.00/ea.
PT66GH424G (met turquoise)	\$119.00/ea.
PT66GH501G (red)	\$119.00/ea.
PT66GHJ (jute insulation)	\$25.00/ea.

1968 Chevelle & Malibu (Hardtop)*(Without Cuts)*

PT68GH100GN (black)	\$79.00/ea.
PT68GH331GN (medium blue)	\$79.00/ea.
PT68GH333GN (light blue)	\$79.00/ea.
PT68GH501GN (red)	\$79.00/ea.
PT68GH645GN (willow gold)	\$79.00/ea.

(With Cuts)

PT68GH100G (black)	\$119.00/ea.
PT68GH331G (medium blue)	\$119.00/ea.
PT68GH333G (light blue)	\$119.00/ea.
PT68GH501G (68 red)	\$119.00/ea.
PT68GH645G (68 willow gold)	\$119.00/ea.
PT68GHJ (jute insulation)	\$25.00/ea.

1969 Chevelle & Malibu (Hardtop)*(Without Cuts)*

PT68GH100GN (black)	\$79.00/ea.
PT68GH369GN (met blue)	\$79.00/ea.
PT68GH432GN (light met green)	\$79.00/ea.
PT68GH469GN (dark met green)	\$79.00/ea.
PT68GH511GN (red)	\$79.00/ea.

(With Cuts)

PT68GH100G (black)	\$119.00/ea.
PT68GH369G (met blue)	\$119.00/ea.
PT68GH432G (light met green)	\$119.00/ea.
PT68GH469G (dark met green)	\$119.00/ea.
PT68GH511G (red)	\$119.00/ea.
PT68GHJ (jute insulation)	\$25.00/ea.

1970 Chevelle & Malibu (Hardtop)*(Without Cuts)*

PT70GH100GN (black)	\$79.00/ea.
PT70GH460GN (met green)	\$79.00/ea.
PT70GH513GN (red)	\$79.00/ea.
PT70GH683GN (saddle)	\$79.00/ea.

(With Cuts)

PT70GH100G (black)	\$119.00/ea.
PT70GH460G (met green)	\$119.00/ea.
PT70GH513G (red)	\$119.00/ea.
PT70GH683G (saddle)	\$119.00/ea.
PT70GHJ (jute insulation)	\$25.00/ea.

1971 Chevelle & Malibu (Hardtop)*(Without Cuts)*

PT70GH100GN (black)	\$79.00/ea.
PT70GH380GN (blue)	\$79.00/ea.
PT70GH415GN (jade green)	\$79.00/ea.
PT70GH690GN (saddle)	\$79.00/ea.
PT70GH697GN (sandalwood)	\$79.00/ea.

(With Cuts)

PT70GH100G (black)	\$119.00/ea.
PT70GH380G (blue)	\$119.00/ea.
PT70GH415G (jade green)	\$119.00/ea.
PT70GH690G (saddle)	\$119.00/ea.
PT70GH697G (sandalwood)	\$119.00/ea.
PT70GHJ (jute insulation)	\$25.00/ea.

1972 Chevelle & Malibu (Hardtop)*(Without Cuts)*

PT70GH100GN (black)	\$79.00/ea.
PT70GH380GN (blue)	\$79.00/ea.
PT70GH465GN (green)	\$79.00/ea.
PT70GH695GN (sandalwood)	\$79.00/ea.

(With Cuts)

PT70GH100G (black)	\$119.00/ea.
PT70GH380G (blue)	\$119.00/ea.
PT70GH465G (green)	\$119.00/ea.
PT70GH695G (sandalwood)	\$119.00/ea.
PT70GHJ (jute insulation)	\$25.00/ea.



TRUNK MATS

Original style rubber trunk mats die-cut to factory specifications to assure a correct fit. Please specify material pattern at time of order.

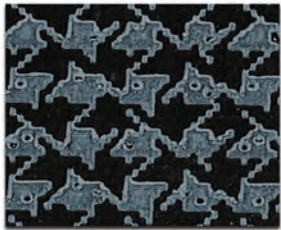

Houndstooth

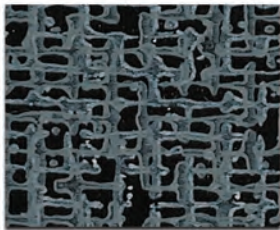

Herringbone

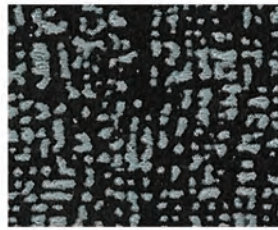

Crowsfoot

SPARE TIRE COVER

Add the finishing touch to your trunk with a spare tire cover to match your trunk mat. Made from the same trunk mat material, these covers will fit any vehicle with a floor mounted spare tire. Please specify material pattern at time of order.



Add the finishing touch to your trunk with a spare tire cover to match your trunk mat. Made from the same trunk mat material, these covers will fit any vehicle with a floor mounted spare tire. Please specify material pattern at time of order.

- 1964-66 Chevelle & Malibu**
- ST64GH-14CF (14" Crowsfoot).....\$65.00/ea.
- ST64GH-15CF (15" Crowsfoot).....\$65.00/ea.

- 1967 Chevelle & Malibu**
- ST67GH-14GHT (14" Gray Houndstooth) ...\$65.00/ea.
- ST67GH-15GHT (15" Gray Houndstooth) ...\$65.00/ea.

- 1968-72 Chevelle & Malibu**
- ST68GH-HB (Felt Herringbone).....\$77.00/ea.

TRUNK DIVIDERS & JUTE INSULATION



Die-cut reproductions of the black fiberboard panel that separates the trunk compartment from the passenger area. Trunk divider jute padding is recommended to provide insulation from moisture and reduces the amount of heat and noise from the trunk compartment.

- 1964-65 Chevelle & Malibu**
- TD64GH(Hardtop models).....\$37.00/ea.
- TD64GHJ (jute insulation).....\$27.00/ea.

- 1966-67 Chevelle & Malibu**
- TD66GH(Hardtop models).....\$37.00/ea.
- TD66GHJ (jute insulation).....\$27.00/ea.

- 1968-72 Chevelle & Malibu**
- TD68GH (Hardtop models).....\$37.00/ea.
- TD68GHJ (jute insulation).....\$27.00/ea.

TRUNK MAT MATERIAL



Legendary Auto Interiors offers an uncut roll of trunk mat material in Houndstooth or Crowsfoot for models not offered. You cut to size.

52" x 80" roll

- TMROLLCF (Crowsfoot).....\$59.00/ea.
- TMROLLHT (Gray Houndstooth).....\$59.00/ea.

1964-72 TRUNK AREA SPEAKER COVER



Die-cut using laminated fiberboard just like the originals, these speaker covers are lined with jute insulator for an exact reproduction.





- 1964-65 Chevelle & Malibu**
- SC64GA (Coupe models).....\$32.00/ea.
- 1966-72 Chevelle & Malibu**
- SC66GA (Coupe models).....\$38.00/ea.



VINYL TOPS CONVERTIBLE TOPS AND ACCESORIES

 facebook.com/legendaryautointeriors
 twitter.com/legendaryautoin

 www.legendaryautointeriors.com
 instagram.com/legendaryautointeriorsltd
 youtube.com/user/legendaryauto



VINYL TOPS

Legendary Auto Interiors, Ltd. "fitted" vinyl tops are manufactured to original specifications with the correct 100% cotton drill backing that gives trouble free installation and long term durability. All seams are double stitched and die-electrically heat-sealed insuring accurate deck width and seam durability. Each top is individually cut and fit for each specific year, make and model to give that perfect Legendary fit. Every Legendary vinyl top carries a (5) year factory warranty, the best in the industry!!

VINYL TOPS

1964-65 Chevelle & Malibu

VTL28GA01S (satin black).....\$399.00/ea.

VTL28GA02S (satin white).....\$399.00/ea.

1966-67 Chevelle & Malibu

VTL29GA01S (satin black).....\$399.00/ea.

VTL29GA02S (satin white).....\$399.00/ea.

1968-69 Chevelle & Malibu

VTL30GHK01S (satin black).....\$399.00/ea.

VTL30GHK02S (satin white).....\$399.00/ea.

1970-71 Chevelle & Malibu

VTL31GHK01S (satin black).....\$399.00/ea.

VTL31GHK02S (satin white).....\$399.00/ea.

1972 Chevelle & Malibu

VTL31GHK01G (gloss black).....\$399.00/ea.

VTL31GHK02G (gloss white).....\$399.00/ea.

1968-71 El Camino

VTL41GE01S (satin black).....\$349.00/ea.

VTL41GE02S (satin white).....\$349.00/ea.

1972 El Camino

VTL41GE01G (gloss black).....\$349.00/ea.

VTL41GE02G (gloss white).....\$349.00/ea.

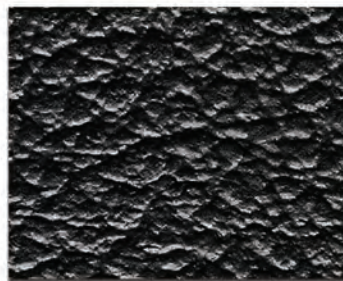

Levant Grain
(Black)

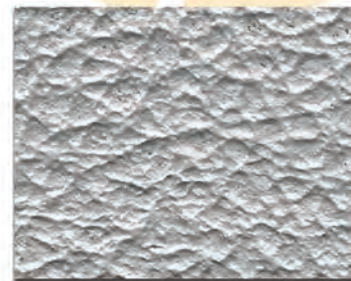

Levant Grain
(White)

NOS VINYL TOPS

Chevrolet offered a variety of vinyl top colors other than black and white for Chevelle and Malibu models. Colors such as blue, teal, green, gold and buckskin have not yet been reproduced. In our efforts to better serve you in your restoration needs, NOS (New Old Stock) vinyl top material is continuously being looked for. Please call for more information.

VTNOS \$1129.00/ea.

☞ Please specify year/make/model and color at time of order.

CONVERTIBLE TOPS AND ACCESSORIES



Legendary Auto Interiors, Ltd. convertible tops are reproduced to factory original specifications using correct heavyweight 36oz. material. Convertible tops are available in the original KV "Pinpoint" grain on all 1964-72 Chevelle & Malibu models. Rear window curtains are available in glass or plastic depending on year and model. We also have convertible tops available for many other models. For colors other than black and white and models not listed, please call for assistance. As with all Legendary Auto Interiors, Ltd. products, these reproduction convertible tops are the finest available and come with a (2) year manufacturer's warranty (glass curtains come with a (1) year warranty) against defects in materials and workmanship.

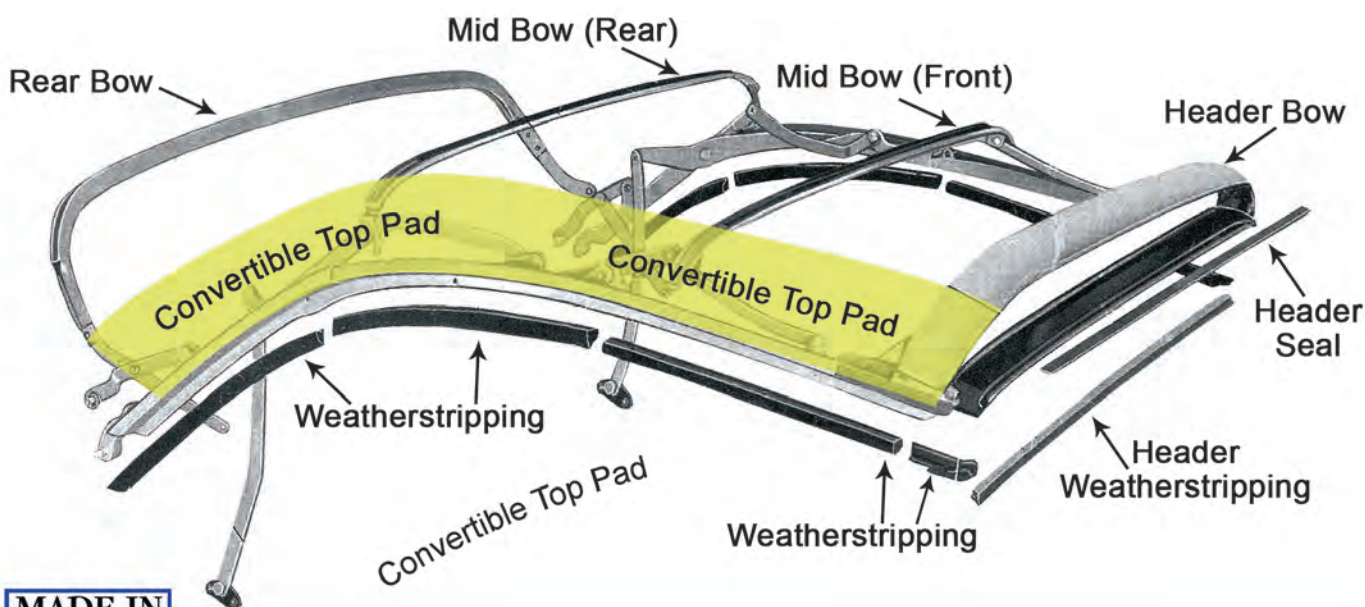

Convertible Top Color Samples

K.V. "Pinpoint Grain"



01 Black

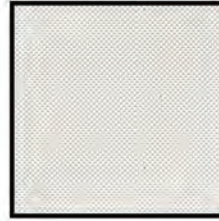

02 White

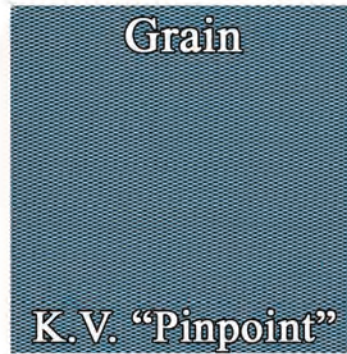

CONVERTIBLE TOPS



1970 Chevelle SS convertible

1964-65 Chevelle & Malibu

CT64GA(C)T (Black and White only) \$399.00/ea.
CT64GA-P (Plastic curtain only) \$229.00/ea.

1968-72 Chevelle & Malibu

CT68GAC)T (Black and White only) \$399.00/ea. 
CG68GA(C) (Glass curtain only)..... \$399.00/ea.

1966-67 Chevelle & Malibu

CT66GA(C)T (Black and White only) \$399.00/ea.
CT66GA-P (Plastic curtain only) \$229.00/ea.

CONVERTIBLE TOP PADS

Universal convertible top pads fit between the top and metal frame rails, protecting the top from wear and damage. Highly recommended with installation of new convertible tops.



CTPAD74STD (1964-67)..... \$79.00/pr.
CTPAD68GA (1968-72)..... \$57.00/pr.

1968-72 CONVERTIBLE HEADER PANEL VINYL

Pre-cut Madrid grain header vinyl wraps over the header bow that attaches to the front of the convertible top frame. Please specify year and color at time of order.



1968-72 Chevelle & Malibu
VV68GAHEADER(C) \$30.00-\$32.00/ea.

1964-72 CONVERTIBLE TOP LATCH HOOKS

Case-hardened steel reproduction hooks secure the top to the upper windshield framing. Chrome plated with pin-holed rubber punch mounting insert included.



1964-72 Chevelle & Malibu
CT64GA-HOOK \$11.00/ea.

1964-72 CONVERTIBLE TOP LATCH HOOK KNUCKLES

Case-hardened steel reproductions are identical to the originals. These latch knuckles pivot at the front end of the latch assembly where the latch hooks (CT64GA-HOOK) thread into place. Complete with rolled press-on attaching pin.



1964-72 Chevelle & Malibu
CT64GA-KNUCKLE..... \$54.00/pr.

CONVERTIBLE TOP TENSION CABLES

These tension cables install into the cable sleeves that are sewn into the convertible top keeping it secure to the top frame.



1964-65 Chevelle & Malibu
CT64GA-CABLE..... \$69.00/pr.

1966-67 Chevelle & Malibu
CT66GA-CABLE..... \$69.00/pr.

1968-72 Chevelle & Malibu
CT68GA-CABLE..... \$49.00/pr.

1964-67 CONVERTIBLE TOP MOTOR COVER

Die-cut black laminated fiber board motor cover has been shape-formed to fit exactly like the original.



1964-67 Chevelle & Malibu
TP64GA..... \$11.00/ea.

1964-65 & 1968-72 CONVERTIBLE TOP GUIDE PIN

These chrome plated pins screw into the top frame and slide into the header panel aligning the convertible top with the front windshield.



1964-65 Chevelle & Malibu
1968-72 Chevelle & Malibu
CT64GA-GUIDE..... \$10.00/ea.

1966-67 CONVERTIBLE TOP PLASTIC GUIDE PINS

These reproduction plastic guide pins, also known as anti-rattle plates, help align the convertible top when latched into place with the windshield header panel.



1966-67 Chevelle & Malibu
CT66GA-GUIDE..... \$39.00/pr.

CONVERTIBLE BOOT DUST COVER

Protect your convertible boot with this convertible boot dust cover made in Levant grain with a satin finish. Comes in Black only



CB67MCBAG01 \$39.00/ea.

CONVERTIBLE BODY SCREW STUDS



5/8" Phillips head stainless steel body screw studs for snap down boot and well liner applications.

CBBOOTBEZSCRW (Pkg/35)..... \$16.00/pk.

CONVERTIBLE BOOTS

Legendary Auto Interior's convertible boots feature protective foam pockets and are sewn to original factory specifications. We are the only manufacturer making "as original" convertible boots using authentic grain vinyls and correct metal snaps or clips by year and model. 1964 models use Seville grain vinyl and 1965-72 models use Madrid grain vinyl. Every Legendary convertible boot carries a (5) year factory warranty, the best in the industry!



1970 Chevelle SS convertible

1964 Chevelle & Malibu CB64GA00017(C)

100G, 220G, 231G
325G, 419G, 508G \$359.00/ea.
656G \$377.00/ea. (L4)

CB64GAP0017(C) *(Plastic Clips)

100G, 220G, 231G
325G, 419G, 508G \$359.00/ea.
656G \$377.00/ea. (L4)

⚠ Plastic Clips are custom and therefore non-returnable, non-refundable

1964 (C) COLOR CODES

(100G) Black	(419G) Light Aqua
(220G) Frost White	(508G) Red
(231G) Fawn	(656G) Saddle
(325G) Metallic Blue	

1965 Chevelle & Malibu

CB65GA00017(C)
100G, 220G, 235G, 325G, 501G \$359.00/ea.
140G, 232G, 420G, 679G \$709.00/ea. (L1)

CB65GAP0017(C) *(Plastic Clips)

(All Colors) \$359.00/ea.
679G \$709.00/ea. (L1)

⚠ Plastic Clips are custom and therefore non-returnable, non-refundable

1965 (C) COLOR CODES

(100G) Black	(325G) Metallic Blue
(140G) Slate	(420G) NOS Lt. Met. Aqua
(220G) Frost White	(501G) Red
(232G) Fawn	(679G) Saddle
(235G) Fawn	

1966 Chevelle & Malibu

CB66GA00017(C)
100G, 220G, 235G, 338G, 511G \$349.00/ea.
420G \$709.00/ea. (L1)
526G \$709.00/ea. (L1)

1966 (C) COLOR CODES

(100G) Black	(338G) Bright Blue
(220G) Frost White	(420G) NOS Lt. Met. Aqua
(235G) Parchment	(511G) Red
(325G) Met. Blue	(526G) NOS Bronze

1967 Chevelle & Malibu

CB66GA00017(C)
100G, 325G, 338G, 501G \$349.00/ea.
424G, 651G \$349.00/ea. (L4)

1967 (C) COLOR CODES

(100G) Black	(424G) Turquoise
(325G) Medium Blue	(501G) Red
(338G) Bright Blue	(651G) Gold

1968 Chevelle & Malibu

CB68GA00017(C)
100G, 204G, 331G, 501G \$349.00/ea.
333G, 645G \$366.00/ea. (L4)

CB68GAE0017(C) (early 68 w/ clips)

100G, 204G, 331G, 501G \$349.00/ea.
333G, 645G \$366.00/ea. (L4)

1968 (C) COLOR CODES

(100G) Black	(333G) Light Blue
(204G) Metallic Parchment	(501G) Red
(331G) Medium Blue	(645G) Willow Gold

1969 Chevelle & Malibu

CB68GA00017(C)
(All Colors) \$349.00/ea.

1969 (C) COLOR CODES

(100G) Black	(511G) Red
(239G) Parchment	
(369G) Dark Blue	

1970 Chevelle & Malibu

CB68GA00017(C)
(All Colors) \$349.00/ea.

1970 (C) COLOR CODES

(100G) Black	(513G) Red
(202G) Pearl White	(683G) Saddle
(310G) Light Metallic Blue	

CONVERTIBLE WELL LINERS

These liners install behind the rear seat protecting your convertible top from wear and damage when placed in the down position. Legendary is the only manufacturer making factory exact well liners available today, backed by a (5) year factory warranty.



1968-72 Well Liner featuring factory correct "crosshatch" material

1964-65 Chevelle & Malibu

WL64GA00016100G (black) \$219.00/ea.
⚠ No plastic strips or snaps. Staples to trim strip before convertible top is installed.

1966-67 Chevelle & Malibu

WL66GA00016100G (black) \$219.00/ea.
⚠ Features a plastic attachment strip.

1968-72 Chevelle & Malibu

WL68GA00016100G (black) \$249.00/ea.
⚠ Features a Rip-Stop plastic pocketed outer lining containing a thick layer of high loft felt. Our well liner is the only correct, as original reproduction well liner available.
⚠ A LEGENDARY AUTO INTERIORS, LTD. EXCLUSIVE

1971 Chevelle & Malibu

CB68GA00017(C)
100G, 690G \$349.00/ea.
415G \$366.00/ea. (L4)

1971 (C) COLOR CODES

(100G) Black	(690G) Saddle
(415G) Jade Green	

1972 Chevelle & Malibu

CB68GA00017(C)
100G, 230G \$349.00/ea.
465G \$366.00/ea. (L4)



1972 (C) COLOR CODES



(100G) Black	(465G) Green
(230G) White	





WEATHERSTRIPING AND ACCESORIES

 facebook.com/legendaryautointeriors
 twitter.com/legendaryautoin

 www.legendaryautointeriors.com
 instagram.com/legendaryautointeriorsltd
 youtube.com/user/legendaryauto

Chevrolet

DOOR WEATHERSTRIPPING

Thick molded rubber weatherstrip includes the necessary clips and correct molded endpads for an excellent fit. These pieces wrap around the bottom and sides of each door.

1964-65 Chevelle & Malibu
WS64GA-DOOR (Hardtop & Conv.).....\$169.00/pr.
WS64GA-DOORS (Sedan).....\$109.00/pr.

1964-65 El Camino
WS64GE-DOOR.....\$159.00/pr.

1966-67 Chevelle & Malibu
WS66GH-DOOR (Hardtop & Conv.).....\$159.00/pr.
WS66GA-DOORS (Sedan).....\$99.00/pr.

1966-67 El Camino
WS66GE-DOOR.....\$109.00/pr.

1968 Chevelle & Malibu
WS68GA-DOOR (Hardtop & Conv.).....\$159.00/pr.

1968-72 Chevelle & Malibu
WS68GA-DOORS (Sedan).....\$99.00/pr.

1968-72 EL Camino
WS68GE-DOOR.....\$99.00/pr.

1969-72 Chevelle & Malibu
WS69GA-DOOR (Hardtop & Conv.).....\$199.00/pr.

HOOD-TO-COWL SEALS

This rubber piece seals the underside of the hood to the cowl. Installs on the front edge of the cowl area where the back edge of the hood meets.

1964-67 Chevelle, Malibu & El Camino
WS64GA-HOOD\$39.00/ea.

1968-72 Chevelle, Malibu & El Camino
WS68GA-HOOD\$29.00/ea.

ROOF RAIL WEATHERSTRIPPING

Thick molded rubber with correct molded endpads. These start at the base of the windshield pillar post and follow along the outer edge of the roofline to the rear of the quarter window.



1964-65 Chevelle & Malibu
WS64GA-ROOF (Hardtop).....\$129.00/pr.

1966-67 Chevelle & Malibu
WS66GA-ROOF (Hardtop).....\$119.00/pr.

1968 Chevelle & Malibu
WS68GA-ROOF (Hardtop).....\$129.00/pr.

1969-72 Chevelle & Malibu (shown)
WS69GA-ROOF (Hardtop).....\$129.00/pr.

TRUNK SEALS

Trunk seal kits feature correct original profile extruded foam for hardtop, sports coupe and convertible models. These seal the trunk lid preventing water leaks. 16' in length.



1964-72 Chevelle & Malibu
TS64GA.....\$29.00/ea.

REAR QUARTER WINDOW SEALS

These seals have a steel core molded inside the rubber and install into the chrome track located on the front edge of the rear roll-up quarter window.



1964-65 Chevelle & Malibu
WS64GA-QTRH (Hardtop).....\$49.00/pr.

1964-65 Chevelle & Malibu
WS64GA-QTRC (Convertible).....\$49.00/pr.

1966-67 Chevelle & Malibu
WS66GH-QTR (Hardtop & Conv.).....\$49.00/pr.

1968-72 Chevelle & Malibu (shown)
WS68GA-QTR (Hardtop & Conv.).....\$59.00/pr.

DOOR LOCK SEALS



These molded rubber "U" shaped seals screw onto the door jamb pillar to seal the front edge of the rear-down windows.

1964-65 Chevelle & Malibu (Hardtop & Conv.)
WS64GA-DOORLK.....\$59.00/pr.

1966-67 Chevelle & Malibu (Hardtop & Conv.)
WS66GA-DOORLK (shown).....\$59.00/pr.

1968-72 Chevelle & Malibu (Hardtop & Conv.)
WS68GA-DOORLK.....\$79.00/pr.

HARDTOP / SEDAN WEATHERSTRIPPING

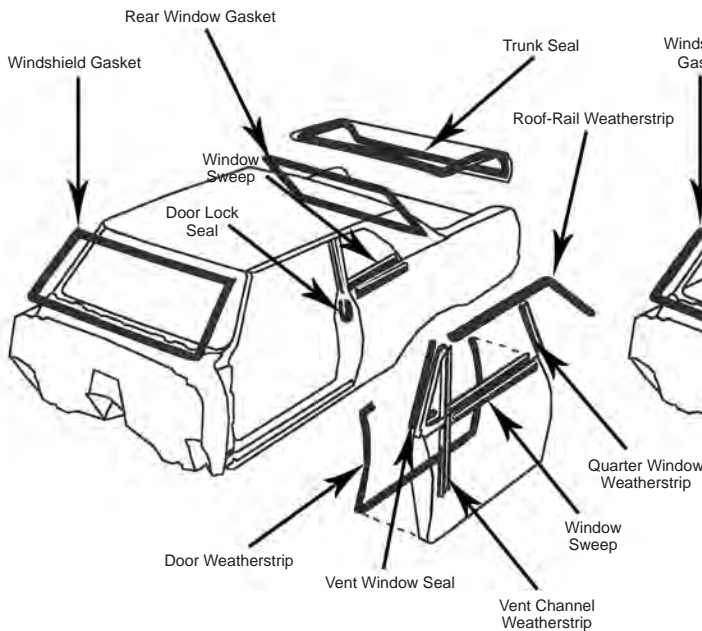

CONVERTIBLE WEATHERSTRIPPING

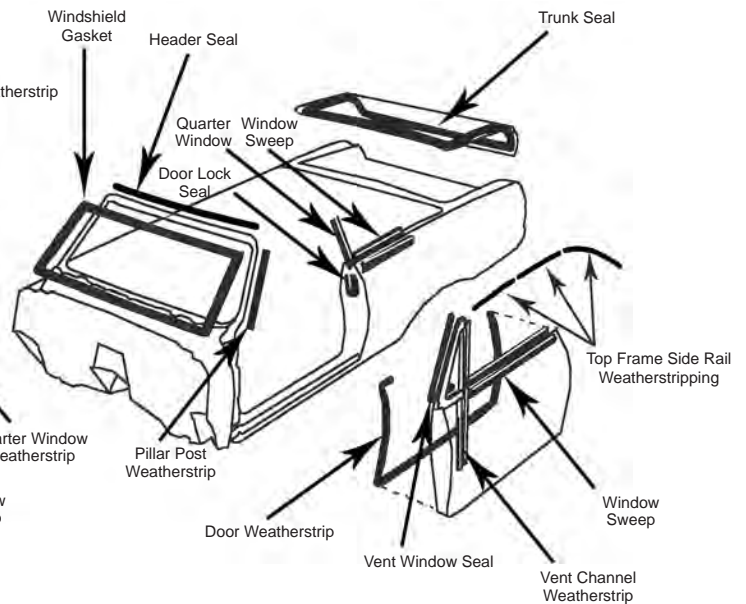

ORIGINAL-STYLE WINDOW SWEEP KITS

Original-style window felts are reproduced with a factory look half-rounded metal bead on the inner and outer channels. Available as complete sets of (8) weather-strips for inner and outer door glass and quarter glass on 2-door models.

1964 Chevelle & Malibu

WS64GHOWINDOWH (Hardtop).....\$164.00/kit
WS64GHOWINDOWC (Convertible)...\$164.00/kit

1964 El Camino

WS64GEOWINDOWS.....\$ 98.00/kit

1965 Chevelle & Malibu

WS65GHOWINDOWH (Hardtop).....\$164.00/kit
WS65GHOWINDOWC (Convertible)...\$164.00/kit

1965 El Camino

WS65GEOWINDOWS.....\$ 98.00/kit

1966-67 Chevelle & Malibu

WS66GHOWINDOWH (Hardtop).....\$195.00/kit
WS66GHOWINDOWC (Convertible)...\$195.00/kit

1966-67 El Camino

WS66GEOWINDOWS.....\$164.00/kit

1968 Chevelle & Malibu

WS68GHOWINDOWH (Hardtop).....\$195.00/kit
WS68GHOWINDOWC (Convertible)...\$195.00/kit

1968-72 El Camino

WS68GEOWINDOWS.....\$164.00/kit

1969 Chevelle & Malibu

WS69GHOWINDOWH (Hardtop).....\$195.00/kit
WS69GHOWINDOWC (Convertible)...\$195.00/kit

1970-72 Chevelle & Malibu

WS70GHOWINDOWH (Hardtop).....\$195.00/kit
WS70GHOWINDOWC (Convertible).\$195.00/kit

HEADER SEALS

Rubber header seal runs along the front of the top and seals against the top of the windshield.

1964-65 Chevelle & Malibu

WS64GA-HS (Convertible).....\$49.00/ea.

1966-67 Chevelle & Malibu

WS66GA-HS (Convertible).....\$79.00/ea.

1968-72 Chevelle & Malibu

WS68GA-HS (Convertible).....\$99.00/ea.

PILLAR POST WEATHERSTRIPPING

These weatherstrip pieces run along the side of the windshield frame A-pillar.

1964-65 Chevelle & Malibu

WS64GA-WSPP (Convertible).....\$99.00/pr.

1966-67 Chevelle & Malibu

WS66GA-WSPP (Convertible).....\$99.00/pr.

1968 Chevelle & Malibu

WS68GA-WSPP (Convertible).....\$99.00/pr.

1969-72 Chevelle & Malibu

WS69GA-WSPP (Convertible).....\$99.00/pr.

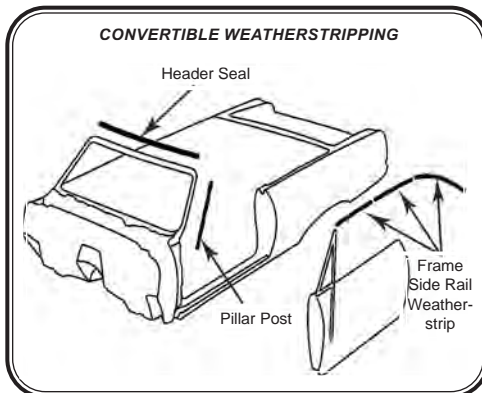

CONVERTIBLE WEATHERSTRIPPING

Header Seal

Pillar Post

Frame Side Rail Weatherstrip

CONVERTIBLE TOP FRAME WEATHERSTRIPPING KITS

Complete convertible top frame kits consist of (1) rubber header seal and (6) molded rubber side rail pieces. (Header seal not shown)



1964-65 Chevelle & Malibu

WS64GA-ROOFC (Convertible)..... \$449.00/kit

1966-67 Chevelle & Malibu

WS66GA-ROOFC (Convertible)..... \$489.00/kit

1968-72 Chevelle & Malibu

WS68GA-ROOFC (Convertible)..... \$449.00/kit

METAL HOOD PAD CLIPS



Reproduction of the original stamped metal hood pad clip for 1964-67 Chevelle, Malibu & El Camino models.

HPGACLIP-M.....\$3.00/ea.

HOOD PAD INSULATION

Die-cut reproductions of the original hood pads come ready to install. These insulating pads help quiet engine noise and absorb heat.

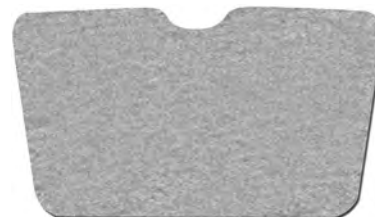

1964 Chevelle, Malibu & El Camino

HP64GH.....\$32.00/ea.

1965 Chevelle, Malibu & El Camino

HP65GH.....\$32.00/ea.

1966 Chevelle, Malibu & El Camino

HP66GH.....\$32.00/ea.

1967 Chevelle, Malibu & El Camino

HP67GH.....\$32.00/ea.

1968-69 Chevelle, Malibu & El Camino

HP68GH.....\$32.00/ea.

1970-72 Chevelle, Malibu & El Camino

HP70GH (without Cowl Induction).....\$32.00/ea.

HP70GH-CI (with Cowl Induction).....\$32.00/ea.

PLASTIC HOOD PAD CLIPS



Reproduction plastic hood pad clips for all 1968-72 Chevelle, Malibu & El Camino models.

HPGACLIP-P.....\$1.00/ea.



Providing the automotive industry
with the world's highest quality
soft trim products and services
RIGHT HERE AT HOME

**STILL ASSEMBLED AND
MADE IN THE** ★★★★★
USA 

THERE REALLY IS A DIFFERENCE!!

Legendary
AUTO INTERIORS LTD.

www.legendaryautointeriors.com



ORDERING INFORMATION

HOW TO ORDER

MAIL, PHONE OR FAXES – When ordering by mail, please fill in all information on the order form that pertains to your vehicle. Print all information and include a telephone number where you can be reached during the day and evening. When ordering for more than one vehicle, please use separate order forms for each vehicle (see order forms in your Legendary Auto Interiors catalog). When ordering by phone, please have your customer number and a list of items ready. You may order conveniently by phone 8:00AM to 6:00PM EST Monday-Friday. Orders may also be sent in by fax 24 hours a day, 7 days a week. Please note that orders faxed in on Saturday or Sunday will not be received and processed until Monday. FAX: 1-800-732-8874

ON-LINE ORDERING – Legendary Auto Interiors, Ltd also offers convenient and easy on-line ordering 24 hours a day, 7 days a week at www.legendaryautointeriors.com. Click on the “Shop Online” tab in the options menu and follow the ordering procedures. Upon completion, Legendary Auto Interiors, Ltd will follow up with an email confirmation so you can verify that your order has been received correctly and is being processed. You may also choose to email your orders by contacting our sales department at sales@legendaryautointeriors.com.

METHODS OF PAYMENT

CREDIT CARDS – Legendary Auto Interiors, Ltd accepts Visa, MasterCard, American Express and Discover for your convenience. Please include the cardholder’s name, billing address, home and business phone, credit card number, expiration date and the 3 or 4 digit security code when placing your orders. Without this information it may slow the processing of your order.

CHECKS AND MONEY ORDERS – Personal Checks will be held 5 business days. To expedite your orders, we suggest paying by Certified Bank Check or Money Order. COD orders are no longer accepted. All payments MUST be in U.S. funds.

SHIPPING SERVICES

DOMESTIC SHIPPING - Legendary Auto Interiors Ltd utilizes both UPS and FedEx Ground for most U.S. parcel shipments which provides our customers the most efficient and cost effective shipping services available. We will ship by the best method for your geographic area unless otherwise specified. We also offer specialized shipping services such as 3 day Select, 2nd day air and Next Day Air for your convenience.

INTERNATIONAL SERVICES – We use the most current and most cost effective international parcel shipping companies available to provide both “Door to Airport” and “Door to Door” services to our overseas customers. We utilize UPS Canadian and FedEx International for Canadian shipments. This provides us with the best possible shipping and brokerage fees for our international customers.

DAMAGES AND SHORTAGES

The carrier is responsible for any merchandise lost or damaged in transit. **Should a package appear to be damaged, OPEN the package while the carrier’s driver is present and note all damages and/or shortages.** If this is not possible and you discover damaged goods or shortages, contact our Customer Service Department immediately! Damages and/or shortage claims must be made within 5 days of receipt of merchandise to ensure our ability to file a claim with the carrier. Please be sure to check all merchandise when you receive it and again before attempting installation.

Legendary Auto Interiors, Ltd. is committed to providing the highest possible level of customer service, however on rare occasions circumstances beyond our control can result in lost or damaged packages. To protect our customers against delays and having to make time consuming phone calls to the carrier, orders will incur a modest \$2.50 insurance fee on each shipment. In the event any products become lost or damaged we will then send replacement parts as quickly as possible, subject to material availability. We will also file the claims and deal with the carrier.

Carriers allow a short period of time to file claims. To take advantage of this service you must notify Legendary Auto Interiors, Ltd. of any damages within 5 days of receiving your delivery. Failure to contact us within this 5 day window will negate Legendary Auto Interiors further involvement.

RETURN POLICY

Legendary Auto Interiors Ltd. will accept returns within the first 30 days of the original invoice date. All items returned within the first 30 days will be subject to a restocking fee of 20-25% depending on item. No returns will be accepted after 30 days. Custom, Special Orders, Specialty Run Materials, Leather and NOS are not eligible for return under any circumstances other than a manufacturing defect. If any product is modified, altered, painted, installed or disassembled in any way without Legendary’s expressed written permission, the item is non-returnable. Legendary always recommends professional installation on all products. Any item which has been altered, painted, installed or deemed non-resalable by Legendary will be returned to the customer at the customer’s expense. Legendary is not responsible or liable for labor fees associated with the installation, modification or repair of any product purchased regardless of the circumstances.

RETURN GOOD INFORMATION

All returns must receive prior approval and an RMA (Return Merchandise Authorization) number prior to return shipping. Packages received by Legendary Auto Interiors Ltd. without prior approval and RMA number will be refused. Return shipping and insurance are the customer’s responsibility. All returned items must be received in as new condition. Examples that render a product non-returnable include, but are not limited to: evidence of attempted installation, parts that have been bent, broken, creased, scratched, soiled, melted or discolored. Also, we will not accept returns for any items that have been altered, painted, repaired or for any reason that has rendered the product non-resalable. Warning: Legendary is not responsible for damaged or lost packages returned by the customer.

CANADIAN CUSTOMER RETURNS

Warranty returns must be clearly marked as follows: **“U.S. GOODS BEING RETURNED FOR REPAIR OR REPLACEMENT UNDER WARRANTY COMMODITY CODE 9801:00V0”**.

PRICES

All prices effective January 1st, 2026 and are subject to change without notice.

HOURS

Monday – Friday 8:00AM to 5:30PM (Eastern Standard Time)

Saturday - By appointment only please

IMPORTANT ADDITIONAL INFORMATION

WARRANTY INFORMATION

Legendary Auto Interiors, Ltd proudly stands behind all of the products and services we offer. All Legendary manufactured sewn interior soft trim products are backed by an exclusive **Limited Lifetime Warranty** for as long as you own your car. In addition, we offer a 5-year warranty on all of our molded, die-electrically heat sealed and exterior soft trim products. Legendary Auto Interiors, Ltd also offers a huge selection of interior components, which we warranty for a maximum of 1 year in accordance with the original manufacturers product warranty. **Product Disclaimer: Normal wear from use or problems due to improper installation are excluded from any warranty.**

LEGENDARY GUARANTEE

All Legendary Auto Interiors, Ltd manufactured products are made to original specifications and are guaranteed to fit. In the event that you experience a problem with any of our products or are dissatisfied with our service, we will make every effort to resolve and correct your issue promptly and do our best to make sure that you are completely satisfied.

INTERIOR COLORS/GRAINS

Legendary Auto Interiors, Ltd offers one of the most diverse product lines available in the marketplace. We feature the correct "color matched" and "grain matching" materials for nearly all models and styles. Due to the extensive number of colors produced by Chrysler, AMC and General Motors, there are some colors, which are simply not available in reproduction form. As the demand for colors increases, we are constantly having previously unavailable colors reproduced. In the event that a vinyl or cloth is not available in reproduction form, the use of NOS material may be required. Please inquire for a current quote, as the price and availability of these NOS materials will vary. To ensure a correct color and grain match, your interior trim code may be required for verification. As color dye lots will vary, we recommend purchasing all your soft trim components at the same time to ensure an exact color match of all components throughout your interior. **Color and grain samples are available upon request at no charge.**

LEATHER INTERIORS

Legendary Auto Interiors, Ltd produces a large number of "as original" leather interiors that are color matched to the original. Special order custom leather interiors are also available upon request. Some applications may require a clean, non-faded sample to ensure the closest possible color match. Leather interior orders may require additional lead-time as well as additional costs, which will be quoted at time of your order. **Note: Due to the variable nature of real leather, minor marks and features are normal and add to the character & individuality of leather products.**

CUSTOM ORDERS

In addition to "As Original" reproduction interiors, Legendary Auto Interiors, Ltd specializes in and is proud to feature "CUSTOM" interiors servicing the Resto-Mod enthusiast. With the introduction of our new & exclusive  product, custom orders have taken on an entirely new look and have given enthusiasts almost limitless options to create a one of a kind interior. Special Order and Custom interiors require approval for all designated materials being used and a signature approval on a "Custom Order" form is also required. Once the Custom work has been approved these orders must be prepaid and are Non-Returnable, Non-Refundable and Non-Cancelable.

INSTALLATION NOTES

Since age deteriorates certain areas of seats due to wear patterns and foam breakdown, certain adjustments and foam repair may be required to complete a perfect fit installation. For this reason, we recommend having a professional automotive interior trim/upholstery shop install your new Legendary Auto Interiors, Ltd soft trim products. As the manufacturer, we know how to install our products better than anyone and we offer complete installation services for both seat upholstery and door panels. For further information, see the **INSTALLATION GUIDE** included with your seat upholstery and door panels or the installation page of this catalog.

PRODUCT DEVELOPMENT & PATTERNS NEEDED

In an effort to develop new upholstery kits, door panels and other soft trim products we work hand in hand with many of our customers who provide their original parts for product development. These items must be ORIGINAL, in fair to good condition and have not been previously repaired or replaced in any way. Our Sales Department must be contacted directly before sending your old upholstery or other soft trim products to us. Since we have no idea about the usability of your parts until we receive them in, you may initially be asked to send photos in an effort to identify the condition of your original parts. Please remember that even if you send in your parts for inspection, we may not be able to use them. **PLEASE NOTE THAT OLD UPHOLSTERY AND OTHER SOFT TRIM ITEMS CANNOT BE RETURNED TO YOU, AS THEY WILL BE DISMANTLED FOR DEVELOPMENT USE.**

MAINTENANCE

All Legendary Auto Interiors, Ltd products may be cleaned with a mild soap and warm water solution. Never scrub or use any kind of harsh pads, brushes or detergents. After cleaning with mild soap and water, lightly clean again with an industrial grade wax and grease remover. (Contact your local auto parts store) Allow surface to dry. LIGHTLY mist with the vinyl protectant of your choice. Install your new parts into your cruising machine. Sit back, enjoy the ride and drive safely!! Note: On leather upholstery applications we recommend using a high-quality mink oil, neatsfoot oil and/or wax. Hand apply, let stand 30-60 minutes and then wipe /buff clean. LIGHTLY rub your soft trim product with oil and wipe excess oil from the surface. **DO NOT USE SILICONE BASED PRODUCTS** as they will deteriorate the thread and dry out leather.

INSTALLATION SERVICES

GM, CHRYSLER & AMC SEAT UPHOLSTERY

(Includes tear down of original upholstery and installation of new upholstery)



Front Buckets Install - \$500.00/pr.
(No Headrest Covers)



Front Buckets w/ Headrest Covers Install - \$600.00/pr.



Front Split Bench Install - \$575.00/ea.



Front Split Bench w/ Headrest Covers Install - \$675.00/ea.



Rear Bench Seat Install - \$400.00/ea.



Headrest Covers Install - \$150.00/pr.

Center Armrest Install - \$150.00/ea.
(for models w/ buckets and no console)



SAVE ON COMPLETE FRONT & REAR INSTALLS!!

Front Buckets & Rear Bench Seat Install - \$750.00/set

Front Buckets w/ Headrest Covers & Rear Bench Seat Install - \$850.00/set

Front Split Bench & Rear Bench Seat Install - \$825.00/set

Front Split Bench w/ Headrest Covers & Rear Bench Seat Install - \$925.00/set

NOTE* Basic installations DO NOT include new foam and cotton replacement or reconstruction, media blasting, painting, welding, frame straightening, polishing or trim detailing. These services are additional and available at an hourly rate. Please call for more details. **1-800-363-8804*

INSTALLATION SERVICES

GM, CHRYSLER & AMC DOOR PANELS

Basic Door Panel Installation

(Includes installation of metal rails and window weatherstrip)

*Convertible rear panel installation DOES NOT include ashtray/well covers
*Ashtray/well covers for General Motors models are available. Call for details



Front Panels (Pair Only) - \$250.00/pr.



Hardtop/Convertible Rear Panels (Pair Only) - \$250.00/pr.

Complete Front & Rear Panels (Pairs Only) - \$500.00/pr.

Deluxe Door Panel Installation

(Includes installation of metal rails, window weatherstrip, metal trim and decorative emblems)

*Convertible rear panel installation DOES NOT include ashtray/well covers
*Ashtray/well covers for General Motors models are available. Call for details



Front Panels (Pair Only) - \$400.00/pr.



Hardtop/Convertible Rear Panels (Pair Only) - \$325.00/pr.

Complete Front & Rear Panels (Pairs Only) - \$725.00/pr.

DOOR PANEL REFURBISHMENT

If we do not list your particular year/make/model vehicle, Legendary Auto Interiors, Ltd. can refurbish your panels back to original for you. The following refurbishing rates include installation of new panels (on your original metal rails), inner window weatherstripping, metal trim and decorative emblems. Please call for instructions before shipping your door panels.

Front Panels (Pair Only) - \$750.00/pr.

Hardtop/Convertible Rear Panels (Pair Only) - \$500.00/pr.

Complete 2-Door Front & Rear Panels (Pairs Only) - \$1250.00/set

Complete 4-Door Front & Rear Panels (Pairs Only) - \$1250.00/set

NOTE Custom refurbishing does not include the refinishing of metal trim and decorative emblems. We highly recommend this work is done before sending the panels.

SHIPPING/HANDLING RATE CHART

<u>Order Value \$</u>	<u>Flat Rate</u>	<u>Oversize Charges</u>	<u>Rate</u>
01-40	\$11	OS1	\$26
41-100	\$23	OS2	\$51
101-200	*\$34	OS3	\$75
201-400	*\$43	*On all orders over \$100	
401-600	*\$58	*NYS Customers - Sales tax will be added	
601-800	*\$78	*AK, HI, PR & International customers call for shipping	
801-1000	*\$113	*Next Day, 2nd Day & 3 Day Select shipping, please call for rates	
1001-1250	*\$165		
1251-1500	*\$172		
1501-1850	*\$216		
1851-2100	*\$259		
2101-2500	*\$296		
2501-2999	*\$334		
3000-up	*\$370		

*Includes \$3.50 for insurance

<u>Oversize Items</u>	<u>Classification</u>	<u>Oversize Items</u>	<u>Classification</u>
Package Tray	OS1	Molded Headliners	OS3
Trunk Divider	OS1	Molded Hood Pads	OS3
Plastic Door Panels	OS1	Pick Up Seat Back Kits	OS3
Pre-Assembled Door Panels	OS1	GM Bench Seat Foam	OS3
2nd Gen F-Body Door Panels	OS1 	E-Body Dash Pads/Caps	OS3
Consoles	OS1	Trunk Packages	OS3
Bucket Molded Foam	OS1		
Install Kits 2-4, 12-15	OS1		
Vinyl Yardage (1yd & up)	OS1		

<u>Oversize Items</u>	<u>Classification</u>
C-Body Carpet Kits	OS2
62-65 B Body Mopar Carpet Kits	OS2
64-69 Cuda Fastback Carpet Kits	OS2
66-67 Charger Fastback Carpet Kits	OS2 
Carpet Yardage	OS2
Sound Dampeners	OS2
Firewall Insulation	OS2
Convertible Glass	OS2
Install Kit 5	OS2

2026 TENTATIVE SHOWS AND DATES

*Spring Carlisle
Chryslers @ Carlisle*

*Fall Carlisle
SEMA*

*Carlisle, PA
Carlisle, PA
Carlisle, PA
Las Vegas, NV*

*April 22 - 26, 2026
July 10 - 12, 2026
Sept 30 - Oct 4, 2026
November 3 - 6, 2026*

Legendary Auto Interiors Ltd. welcomes the opportunity to support the smaller clubs' and organizations' car shows and swap meets. A variety of flyers, catalogs and gift certificates are available to clubs and organizations who sponsor shows nationwide. Please call or write for additional information. The list above is a tentative schedule subject to change without notice. Come visit us at many car shows/swap meets and see what makes a Legendary interior... truly Legendary.



Legendary
AUTO INTERIORS LTD.

Table of Contents - Chevelle, Malibu & El Camino

SEAT UPHOLSTERY & TRIM ACCESORIES C1-C16

Bench Seatback Release Knob.....	C16	Bucket Seat Spring Assembly	C16
Bucket Seat Back Panels	C15	Cotton Rolls	C15
Bucket Seat Back Release Buttons.....	C16	Headrest Covers.....	C2-C3, C6-C10, C12-C14
Bucket Seat Bases	C15	High Density Foam	C15
Bucket Seat Chrome Trim	C15	Hog Ring Plier Kits	C15
Bucket Seat Headrests.....	C16	Muslin	C15
Bucket Seat Headrest Lock Assembly.....	C16	Seat Adjustment Knobs	C15
Bucket Seat Headrest Mounting Kit.....	C16	Seat Back Bumpers.....	C16
Bucket Seat Hinge End Cap.....	C16	Seat Bottom Stretch Panel Boards.....	C15
Bucket Seat Mount Conversion Brackets.	C16	Seat Cover Medallions	C16
		Seat Upholstery.....	C2-C14

MOLDED FOAM & FOAM ACCESORIES C17-C20

Installation Services.....	C20
Molded Foam.....	C18
Seat Upholstery Installation Kits.....	C19

DOOR PANELS & TRIM ACCESORIES C21-C32

Armrest Bases	C28	Door Panel Medallions	C29
Armrest Base Chrome Back Plate.....	C28	Door Panel Trim Molding	C30
Armrest Base Molding	C28	Door Panel Watershields	C29
Armrest Base Screw Set	C29	Door Panel Windlace.....	C30
Armrest Pads.....	C28	Door Sill Plates	C30
Ashtrays.....	C30	Door & Window Handle Plastic Washer	C31
Armrest/Ashwell Covers	C22-C28	Door & Window Handle Retaining Clip.....	C31
Ashwell Installation Pad Kits.....	C29	Hinge to Door Bolts	C32
Conv. Courtesy Light Lens & Bezels	C30	Jute Backing	C32
Door Handles.....	C31	Lower Door Hinge Pins.....	C32
Door Handle & Lock Gaskets	C32	Lower Door Spring.....	C32
Door Hinges.....	C32	Outer Door Handles.....	C32
Door Jamb Windlace	C30	Rear Armrest Panels	C28
Door Lock Ferrules	C29	Seat Belt Bolts	C32
Door Lock Knobs	C29	Upper Door Jamb End Caps	C30
Door Lock Striker.....	C32	Vent Window Cranks	C31
Door Panels.....	C22-C27	Vent Window Handles	C31
Door Panel Clips & Retainers.....	C30	Window Crank Handles	C31
		Window Handles Springs	C31

CARPETS, FLOORMATS & ACCESORIES C33-C42

Carpet.....	C36	Floormats.....	C41-C42
Carpet Color Selector.....	C35	Floormat Color Selector.....	C40
Carpeted Floormats.....	C36	Kick Panels.....	C36
Carpet Yardage	C36	Kick Panel Insulation	C36
Firewall Insulation.....	C36	Sound Deadener	C36
Firewall Guard Fastener	C36	Sound Dampening.....	C36

DASHES, CONSOLES, SHIFTERS & ACCESORIES C47-C50

Center Consoles.....	C48	Firewall Steering Column Cover.....	C48
Center Console Rear Light Panel.....	C48	Gas Pedal Spring & Rod Pin	C50
Console Lid Covers	C49	Glovebox Emblems	C49
Console Mounting Brackets.....	C49	Glovebox Liners.....	C49
Console Shifter Inserts & Slides	C49	Pedal Pads & Bezels	C50
Console Top Plates.....	C49	Shifter Boots.....	C50
Dash Pads.....	C48	Steering Column Covers	C50
Dash Steering Column Seal	C50	Underdash Insulation.....	C49

HEADLINERS & TRIM ACCESORIES C51-C56

Dome Light Lens & Bezels	C53	Rear Window Trim	C54
Convertible Sunvisor Brackets	C54	Sail Panel Boards	C54
Headliners	C53	Sunvisors.....	C56
Headliner Bow Retainer Clips.....	C53	Sunvisor Supports	C54
Headliner Color Selector	C52	Sunvisor Tip & Bushing Kit	C54
Headliner Insulation.....	C53	Upper Windshield Trim	C54
Pillar Post Moldings	C54		

Table of Contents - Chevelle, Malibu & El Camino

PACKAGE TRAY AND TRUNK ACCESORIES C57-C60

Package Tray & Jute Insulation.....	C58-C59
Spare Tire Cover	C60
Trunk Area Speaker Cover	C60
Trunk Divider & Jute Insulation.....	C60
Trunk Mats.....	C60
Trunk Mat Material.....	C60

VINYL TOPS, CONVERTIBLE TOPS & ACCESORIES C61-C66

Convertible Body Screw Studs	C66
Convertible Boots	C66
Convertible Header Panel Vinyl.....	C65
Convertible Tops.....	C64
Convertible Top Color Selector.....	C64
Convertible Top Guide Pin.....	C65
Convertible Top Latch Hooks.....	C65
Convertible Top Latch Hook Knuckles.....	C65
Convertible Top Motor Cover.....	C65
Convertible Top Pads	C65
Convertible Top Plastic Guide Pins	C65
Convertible Top Tension Cables	C65
Convertible Well Liners.....	C66
Vinyl Tops	C62

WEATHERSTRIPPING & ACCESORIES C67-C69

Convertible Top Frame Weatherstrip Kit....	C69
Door Lock Seals	C68
Door Weatherstripping.....	C68
Header Seals.....	C69
Hood Pad Clips.....	C69
Hood Pad Insualtion	C69
Hood to Cowl Seals	C68
Pillar Post Weatherstripping	C69
Rear Quarter Window Seals.....	C68
Roof Rail Weatherstripping.....	C68
Trunk Seals	C68
Window Sweep Kits.....	C69



OVER 225 DIFFERENT INTERIOR STYLES OFFERED FOR CHRYSLER & AMC

1957-76 MOPAR A,B,C,E & F-BODY, 1963-68 DODGE A-100 VAN
1973-79 DODGE TRUCK & 1968-74 AMC JAVELIN/AMX

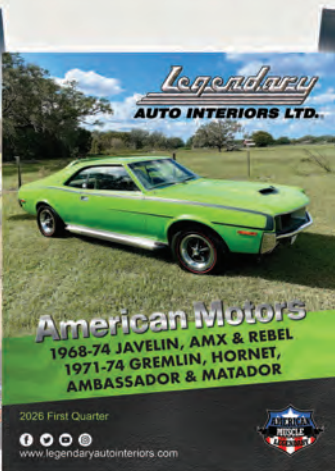
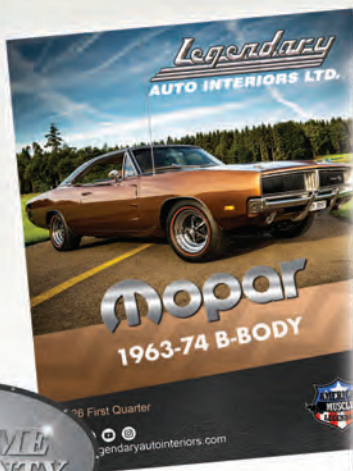

WWW.LEGENDARYAUTOINTERIORS.COM

Legendary Auto Interiors, Ltd.
121 West Shore Blvd
Newark, NY 14513

We're Social!

 facebook.com/legendaryautointeriors

 youtube.com/user/legendaryauto

 x.com/legendaryautoin

 instagram.com/legendaryautointeriorsltd



LEGENDARY AUTO INTERIORS
1-800-363-8804

WWW.LEGENDARYAUTOINTERIORS.COM