

Legendary

AUTO INTERIORS LTD.®



Mopar

**1957-73 C-BODY
& 1964-79 TRUCK**

2026 Second Quarter



www.legendaryautointeriors.com





OVER 225 DIFFERENT INTERIOR STYLES OFFERED FOR CHRYSLER & AMC

1957-76 MOPAR A,B,C,E & F-BODY, 1963-68 DODGE A-100 VAN
1973-79 DODGE TRUCK & 1968-74 AMC JAVELIN/AMX

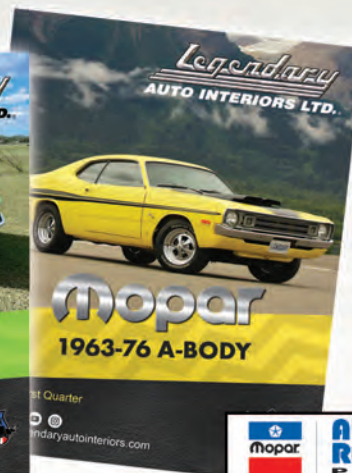
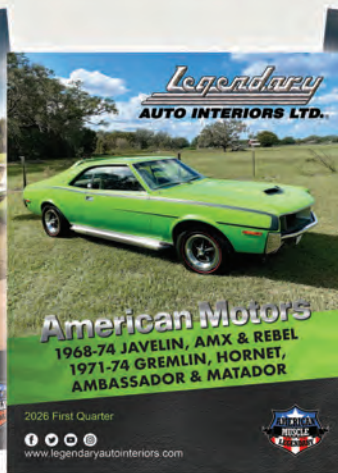
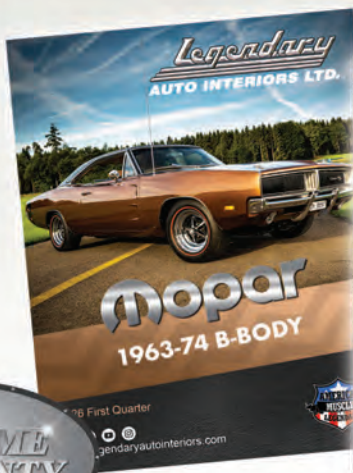

WWW.LEGENDARYAUTOINTERIORS.COM

A Special Message from the President...

For over 4 decades, Legendary Auto Interiors, Ltd has been committed to providing the automotive restoration industry and enthusiast with the world's highest quality soft trim products and services. Available from the most authentic "As Original" interiors to the most extreme "One of a Kind" Custom Resto-Mod interiors, Legendary has been relied upon and Legendary has delivered!

This past decade has been extremely exciting! We continue to set the bar and truly lead by example, establishing industry expectations and standards. Introducing innovative tools such as our exclusive "Custom Design Center", "LegendImagery™" and "Sample Request Center". Whether your preference is "As Original" or a creation of your own vision, we have created a destination where you can let your imagination lead the way! Our commitment to developing and maintaining innovative solutions is a dedicated process that will continue to provide you with great products, service and help grow our restoration industry.

We are looking forward to a very productive future. As owner and President and from all of our proud team here at Legendary Auto Interiors LTD, we would like to thank you for allowing us the opportunity and the privilege of being your automotive soft trim supplier.

Thank you once again for your business, interest and support!

Sincerely yours,

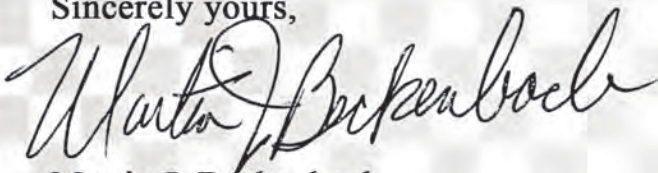

Martin J. Beckenbach
President

PRODUCT DISCLAIMER: Products listed in this catalog have been reproduced and/or remanufactured to resemble original products. All manufacturers names and descriptions are used for reference purposes only. It is therefore understood that the products listed in this catalog are in fact REPRODUCTIONS unless specified otherwise. All parts described and offered for sale in this publication as NOS (New Old Stock) are new parts/materials manufactured by or for Chrysler LLC and General Motors Corporation.

All literature produced by and directly related to Legendary Auto Interiors Ltd., is protected under copyright laws.
All literature cannot be reproduced for any reason unless prior permission is obtained.



FLEX TREAD®

YOU ASK FOR IT...WE DELIVERED!!

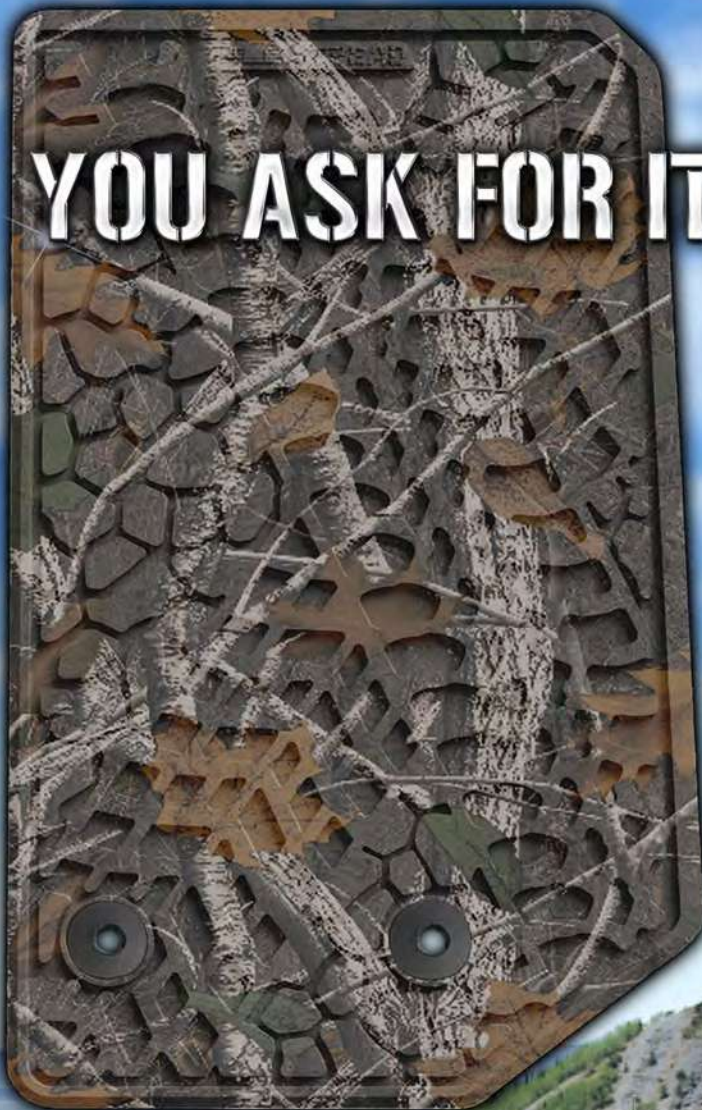

YOU ASK FOR IT...WE DELIVERED!!



Flextread is providing the most innovative
molded floormats in the industry
RIGHT HERE AT HOME!

All products are 100% assembled, designed
and made in the U.S.A.



THE NEXT GENERATION IN FLOORMATS™

FLEXTREAD®



INTRODUCING THE BEST WARRANTY COVERAGE IN THE INDUSTRY!!

Limited Lifetime Warranty

Limited Warranty - Legendary Auto Interiors Ltd. (called "we") warrants that the products it manufactures will be free of defects in materials and workmanship from the date it is first purchased by the retail purchaser. A retail purchaser is any person or any entity who or which purchases the product but does not do so for resale.

Warranty Information - Legendary Auto Interiors, Ltd proudly stands behind all of the products and services we offer. All Legendary manufactured sewn interior soft trim products are backed by an exclusive Limited Lifetime Warranty for as long as you own your car. In addition, we offer a 5-year warranty on all of our molded, die-electrically heat sealed and exterior soft trim products. Legendary Auto Interiors, Ltd also offers a huge selection of interior components, which we warranty for a maximum of 1 year in accordance with the original manufacturers product warranty.

Obligation - If a product is not as warranted, we will either repair or, at our option, replace the defective product. If repair or replacement is not possible within a reasonable time, we will refund the purchase price.

Exclusions from Warranty - This Warranty does not apply to:

1. Conditions resulting from the product being altered, abused, misused, damaged by accident or negligence; being repaired without our authorization; or not being maintained properly in accordance with written instructions provided with the product.
2. Conditions resulting from ordinary wear and tear or including, without limitation, exposure to ultraviolet light.
3. Conditions resulting from the use of Specialty Run Materials (SRM) supplied by the purchaser.
4. Conditions resulting from improper installation by the purchaser or anyone else outside of our control.

Disclaimer - EXCEPT FOR THE LIMITED WARRANTY DESCRIBED ABOVE, WE OFFER NO WARRANTIES, EXPRESSED OR IMPLIED, AND OTHER THAN THE LIMITED WARRANTY EXPRESSLY CONTAINED HEREIN, WE HEREBY DISCLAIM ANY AND ALL WARRANTIES, INCLUDING WITHOUT LIMITATION ANY IMPLIED WARRANTIES OF MERCHANTABILITY, SUITABILITY OR FITNESS FOR A PARTICULAR PURPOSE. Some states do not allow limitations on how long an implied warranty lasts, so the above limitation may not apply to you.

Exclusion of Incidental and Consequential Damages - WE ARE NOT RESPONSIBLE FOR ANY INCIDENTAL OR CONSEQUENTIAL DAMAGES RESULTING FROM BREACH OF THE LIMITED WARRANTY DESCRIBED ABOVE. Some states do not allow the exclusion or limitation of incidental or consequential damages, so the above limitation or exclusion may not apply to you.

Other Legal Rights - This Warranty gives you specific legal rights, and you may also have other rights which vary from state to state.

What To Do If You Have A Warranty Claim - If you have a warranty claim, you must call our sales office for further assistance. Once given a return authorization number please indicate the number on the box and return the product to our facility; Legendary Auto Interiors 121 West Shore Blvd, Newark, NY 14513. We will perform our warranty obligation within a reasonable amount of time after the returned product arrives at our facility.

Eff. 08/01/2024



























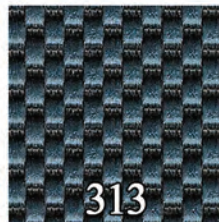







PRODUCT DISCLAIMER: Products listed in this catalog have been reproduced and/or remanufactured to resemble original products. All manufacturers names and descriptions are used for reference purposes only. It is therefore understood that the products listed in this catalog are in fact REPRODUCTIONS unless specified otherwise. All parts described and offered for sale in this publication as NOS (New Old Stock) are new parts/materials manufactured by or for Chrysler Group LLC and General Motors Corporation.

LEGENDARY AUTO INTERIORS LTD., COPYRIGHT 2026

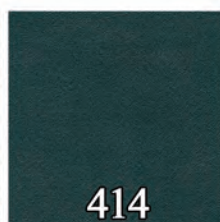
All literature produced by and directly related to Legendary Auto Interiors Ltd., is protected under copyright laws. All literature cannot be reproduced for any reason unless prior permission is obtained.

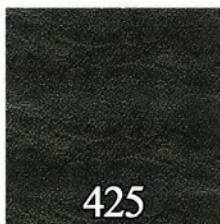
Vinyl Color Chart

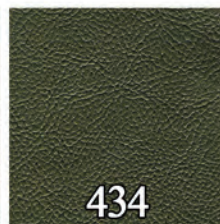
 100 Black	 102 Silver	 112 Dark Gray	 134 Platinum	 200 White	 202 Pearl White
 204 Dark White	 206 Taupe	 230 68 Metallic Parchment	 250 Parchment	 264 Parchment	 266 Metallic Parchment
 302 Blue	 304 Light Blue	 307 Blue	 310 Lt. Met. Powder Blue	 313 Met. Navy/ Black Filled	 314 Metallic Blue
 318 Lt. Metallic Blue	 320 Metallic Navy	 322 Medium Metallic Blue	 330 Dark Met. Blue	 332 Lt. Metallic Blue	 333 Dark Blue
 336 Navy Blue	 339 Metallic Blue	 406 Light Turquoise	 410 Lt. Met. Olive	 412 Light Metallic Turquoise	 414 Dark Metallic Turquoise
 416 Metallic Turquoise	 420 Citron	 425 Green	 430 Dark Metallic Green	 432 Light Metallic Green	 434 Dark Metallic Green

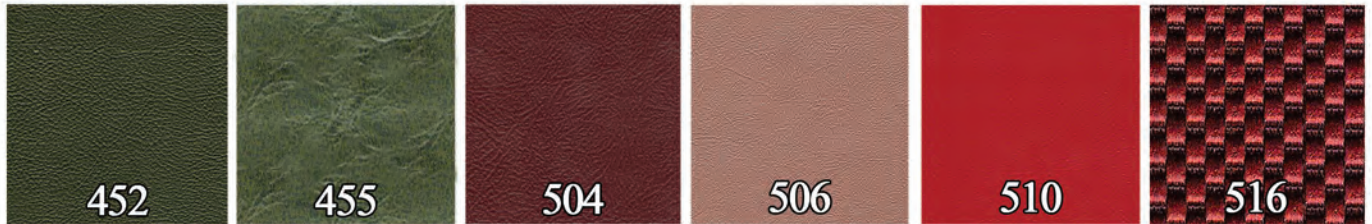

Dark Metallic Green

Antique Green

Dark Red

Metallic Rosewood

Crimson Red

Met. Red/ Blk Filled

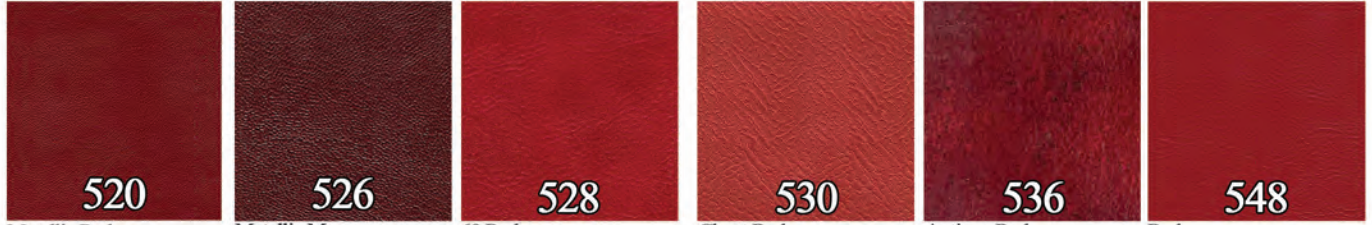

Metallic Red

Metallic Maroon

69 Red

Claret Red

Antique Red

Red



Chestnut

Copper

Copper

Dark Copper

Dk. Brn/ Blk Filled

Metallic Fawn



Gold

Ginger

Light Gold

Copper

Dark Metallic Brown

Dark Copper

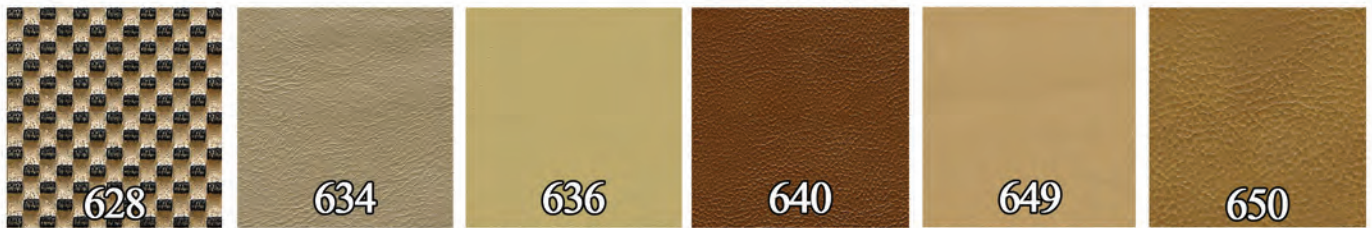

Gold/ Black Filled

Light Metallic Fawn

Ember Gold

Bronze

Tan

Saddle

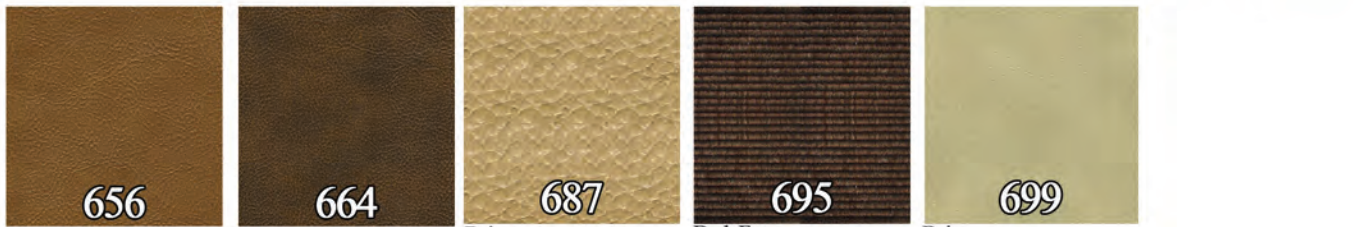

Brown

Brown

Beige

Dark Fawn

Beige

Cloth Color Chart



398

Dodge 440 Cloth Blue



488

Dodge 440 Cloth Olive



498

Dodge 440 Cloth Turquoise



588

Dodge 440 Cloth Red



688

Champagne Cloth

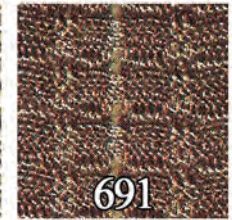

691

NOS Fawn Cloth



760

67 NOS Cloth Blue

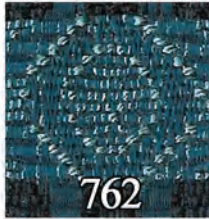

762

67 Fury I Cloth Turquoise



764

67 Fury I Cloth Gold

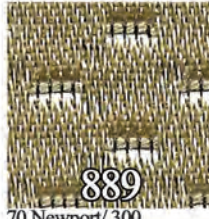

889

70 Newport/300 Tan Cloth



892

Black Cloth



900

64 Fury Blue Cloth



902

64 Fury Fawn Cloth



904

64 Fury Turquoise Cloth



906

64 Fury Red Cloth



908

64 Fury Copper Cloth



938

Black Cloth



939

Navy Cloth

Vinyl Grain Chart

Grain Ascot Grain	Grain Bambino Grain	Grain Bison Grain	Grain Boar Grain
Chrysler Basketweave	Coachman	Cologne	Diamond Waffle
Grain Dorchester Grain	Grain El Paso Grain	Grain Haircell Grain	Grain 1/16" Rib Grain
Oxen Grain	Oxford Grain	Pinpoint	Rosette
Shallow Elk	Star		

Vinyl Yardage

The following grains are available off the roll and come in 1/2 yard increments ONLY

Ascot VVYDASCOT(C) (1 Yard).....\$64.00/yd.  VV1/2YDASCOT(C) (1/2 Yard).....\$32.00/ea. <i>Available colors: 100</i>	Madrid VVYDMADRID(C) (1 Yard).....\$64.00/yd.  VV1/2YDMADRID(C) (1/2 Yard).....\$32.00/ea. <i>Available colors: 100G, 202G, 204G, 210G, 220G, 230G, 235G, 239G, 240G, 310G, 325G, 331G, 333G, 334G, 338G, 342G, 343G, 351G, 369G, 380G, 415G, 420G, 421G, 424G, 429G, 448G, 460G, 465G, 469G, 501G, 511G, 513G, 520G, 631G, 635G, 640G, 642G, 645G, 650G, 651G, 657G, 658G, 670G, 679G, 683G, 690G, 694G, 695G, 697G, 709G, 710G</i>
Bison VVYDBISON(C) (1 Yard).....\$64.00/yd.  VV1/2YDBISON(C) (1/2 Yard).....\$32.00/ea. <i>Available colors: 100, 204, 314, 510, 606, 610</i>	Oxen VVYDOXEN(C) (1 Yard).....\$64.00/yd.  VV1/2YDOXEN(C) (1/2 Yard).....\$32.00/ea. <i>Available colors: 100</i>
Coachman VVYDCOACHMAN(C) (1 Yard).....\$64.00/yd.  VV1/2YDCOACHMAN(C) (1/2 Yard).....\$32.00/ea. <i>Available colors: 100, 130, 140, 200, 330, 338, 340, 432, 434, 452, 528, 540, 550, 560, 640, 650, 656, 664, 666, 670</i>	Oxford VVYDOXFORD(C) (1 Yard).....\$64.00/yd.  VV1/2YDOXFORD(C) (1/2 Yard).....\$32.00/ea. <i>Available colors: 100, 200, 264, 360, 450</i>
Cologne VVYDCOLOGNE(C) (1 Yard).....\$64.00/yd.  VV1/2YDCOLOGNE(C) (1/2 Yard).....\$32.00/ea. <i>Available colors: 100, 102, 10A, 202, 318, 320, 332, 414, 420, 430, 520, 526, 614, 620, 636</i>	Ranger VVYDRANGER(C) (1 Yard).....\$64.00/yd.  VV1/2YDRANGER(C) (1/2 Yard).....\$32.00/ea. <i>Available colors: 100, 200</i>
Doeskin VVYDDOESKIN(C) (1 Yard).....\$64.00/yd.  VV1/2YDDOESKIN(C) (1/2 Yard).....\$32.00/ea. <i>Available colors: 100, 104, 200, 206G, 508G</i>	Shallow Elk VVYDSHALLOWELK(C) (1 Yard).....\$64.00/yd.  VV1/2YDSHALLOWELK(C) (1/2 Yard).....\$32.00/ea. <i>Available colors: 100, 156, 200, 202G, 230G, 341</i>
Dorchester VVYDDORCHESTER(C) (1 Yard).....\$64.00/yd.  VV1/2YDDORCHESTER(C) (1/2 Yard).....\$32.00/ea. <i>Available colors: 100, 202</i>	Sierra VVYDSIERRA(C) (1 Yard).....\$64.00/yd.  VV1/2YDSIERRA(C) (1/2 Yard).....\$32.00/ea. <i>Available colors: 100G, 102G, 200G, 209G, 319G, 528G, 684G, 688G</i>
El Paso VVYDELPASO(C) (1 Yard).....\$64.00/yd.  VV1/2YDELPASO(C) (1/2 Yard).....\$32.00/ea. <i>Available colors: 100, 200</i>	
Krinkle VVYDKRINKLE(C) (1 Yard).....\$64.00/yd.  VV1/2YDKRINKLE(C) (1/2 Yard).....\$32.00/ea. <i>Available colors: 100, 154</i>	

1 YARD AND MORE IS SHIPPED OVERSIZED 1

Specialty Grain Vinyl Yardage

All grain/color combinations not listed above can be produced upon request.
Available in 1/2 yd or 1yd sheets ONLY

1/2 Yard (54"x18")
 TTMOLDSMALL.....\$36.00/ea.
 * Need to specify grain and color

1 Yard (54"x36")
 TTMOLDXL.....\$96.00/ea. 
 * Need to specify grain and color



Providing the automotive industry
with the world's highest quality
soft trim products and services
RIGHT HERE AT HOME

**STILL ASSEMBLED AND
MADE IN THE** ★★★★★
USA 

THERE REALLY IS A DIFFERENCE!!

Legendary
AUTO INTERIORS LTD.

www.legendaryautointeriors.com





UPHOLSTERY AND TRIM ACCESORIES

 facebook.com/legendaryautointeriors

 twitter.com/legendaryautoin

 www.legendaryautointeriors.com

 instagram.com/legendaryautointeriorsltd

 youtube.com/user/legendaryauto

1963 POLARA 500

This Legendary product features as-original
Bison grain inserts with Bison grain accent & Bison grain skirts.

(C) COLOR CODES:

- (113) - Black (100) / White (204) [Trim Code 656]
- (207) - Taupe (206) / White (204) [Trim Code 653]
- (303) - Blue (302) / White (204) [Trim Code 651]
- (407) - Turquoise (406) / White (204) [Trim Code 658]
- (514) - Crimson Red (510) / White (204) [Trim Code 655]

(C) SEATBACK PANEL COLOR CODES:

- (204) - White

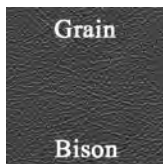

- Front Buckets **AA63CP00010(C)**
- 113, 514.....\$709/pr.
- 207, 303, 407.....\$744/pr. (L4)

*Please specify carpet color of stretch panel at time of order.
*Molded foam is available for this model. See the "Molded Foam" section in this catalog.

- Front Bucket Seatback Panels **SK63CFP0018(C)**
- (Pre-sewn vinyl & carpet panels with new boards)
- 204.....\$204/pr.

*Please specify carpet color art time or order.

- Hardtop Rear Bench..... **AA63CP00040(C)**
- Convertible Rear Bench **AA63CP00050(C)**
- 113, 514.....\$658/ea.
- 207, 303, 407.....\$691/ea. (L4)

1964 POLARA 500

This Legendary product features as-original
Bison grain inserts with Bison grain skirts.

- Front Buckets **AA64CP00010(C)**
- 101, 503.....\$709/pr.
- 611.....\$774/pr. (L4)
- 311, 417.....\$946/pr.
- 413.....\$1370/pr. (L1)

*Specify silver tinsel or color of vinyl cordwelt around seat and back panel inserts at time of order.
*Specify carpet color of stretch panel at time of order.
*Molded foam is available for this model. Please see the "Molded Foam" section in this catalog.

- Front Bucket Seatback Panels **SK64CP00018(C)**
- (Pre-sewn vinyl with new boards)

- 101, 314, 416, 510.....\$193/pr.
- 610.....\$203/pr. (L4)
- 410.....\$352/pr. (L1)

- Hardtop Rear Bench..... **AA64CP00040(C)**
- Convertible Rear Bench **AA64CP00050(C)**

- 101, 503.....\$658/ea.
- 611.....\$691/ea. (L4)
- 311, 417.....\$896/ea.
- 413.....\$1213/ea. (L1)



(C) COLOR CODES:

- (101) - Black with Silver Tinsel welt [Trim Code P4X]
- (311) - Blue (314) w/ Powder Blue (310) Accent [Trim Code P4B]
- (413) - Olive Gold (410) w/ Pearl White (202) Accent [Trim Code P4Y]
- (417) - Turquoise (416) w/ Light Turquoise (412) Accent [Trim Code P4Q]
- (503) - Red (510) w/ Pearl White (202) Accent & Silver Tinsel welt [Trim Code P4R]
- (611) - Fawn Tan (610) w/ Pearl White (202) Accent [Trim Code P4T]

1965 POLARA 500

This Legendary product features as-original
Cologne grain inserts with Bison grain skirts.

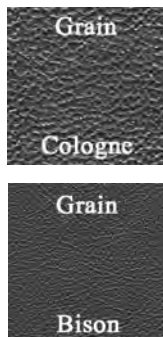

- Front Buckets **AA65CP00010(C)**
- (All colors).....\$709/ea.

*Please specify carpet color of stretch panel at time of order.
*Molded foam is available for this model. See the "Molded Foam" section in this catalog.

- Front Bucket Seatback Panels **SK65CP00018(C)**
- (Pre-sewn vinyl & carpet panels with new boards)

- 100, 314, 520.....\$204/pr.

*Please specify carpet color art time or order.

- Hardtop Rear Bench..... **AA65CP00048(C)**
- (All colors).....\$646/ea.

(C) COLOR CODES:

- (100) - Black [Trim Code L9X]
- (325) - Dark Blue (322) / Light Blue (314) [Trim Code L9B]
- (520) - Red [Trim Code L9R]



1964 POLARA

This Legendary product features as-original Bison grain inserts with heat sealed chrome emblems & Bison grain skirts.

(C) COLOR CODES:

- (100) - Black [Trim Code H4X]
- (314) - Blue [Trim Code H4B]
- (410) - Olive Gold [Trim Code H4Y]
- (416) - Turquoise [Trim Code H4Q]
- (510) - Crimson Red [Trim Code H4R]
- (610) - Fawn Tan [Trim Code H4T]

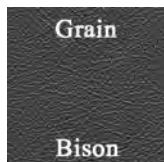

Front Split Bench with Center Armrest	AA64CP00030(C)
100, 314, 416, 510	\$843/ea.
610	\$885/ea. (L4)
410	\$1703/ea. (L1)
Hardtop Rear Bench.....	AA64CP00080(C)
Convertible Rear Bench	AA64CP00060(C)
100, 314, 416, 510	\$736/ea.
610	\$773/ea. (L4)
410	\$1476/ea. (L1)

1964 DODGE 440

This Legendary product features as-original Cloth inserts with Bison grain skirts.

(C) COLOR CODES:

- (399) - Blue Cloth (398) / Blue (314) [Trim Code M1B]
- (489) - Gold Cloth (488) / Olive Gold (410) [Trim Code M1Y]
- (499) - Turquoise Cloth (498) / Turquoise (416) [Trim Code M1Q]
- (589) - Red Cloth (588) / Crimson Red (510) [Trim Code M1R]
- (692) - Fawn Cloth (691) / Fawn Tan (610) [Trim Code M1T]



Front Bench.....	AA64CD4C020(C)
399, 499, 589, 692	\$1115/ea.
489	\$1415/ea.
Hardtop Rear Bench.....	AA64CD4C080(C)
399, 499, 589, 692	\$881/ea.
489	\$1184/ea.

1963 SPORT FURY

This Legendary product features as-original Pinpoint grain inserts & heat sealed center accent strip with chrome emblem with Bison grain skirts.

(C) COLOR CODES:

- (117) - Black (100) with Copper (604) Accent [Trim Code 459]
- (305) - Blue (302) with Light Blue (304) Accent [Trim Code 451]
- (513) - Crimson Red (510) with Dark White (204) Accent [Trim Code 455]

(C) SEATBACK PANEL COLOR CODES:

- (100) - Black
- (302) - Blue
- (510) - Crimson Red

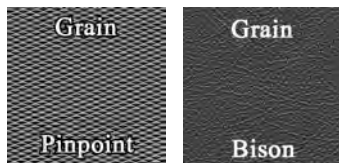

Front Buckets	AA63CF00010(C)
513	\$746/pr.
305	\$783/pr. (L4)
117	\$947/pr. (L1)
*Please specify carpet color of stretch panel at time of order.	
*Molded foam is available for this model. Please see the "Molded Foam" section in this catalog.	
Front Bucket Seatback Panels	SK63CFP0018(C)
(Pre-sewn vinyl and carpet panels with new boards)	
100, 302, 510	\$204/pr.
*Please refer to carpet color selection at time of order.	
Hardtop Rear Bench.....	AA63CF00040(C)
Convertible Rear Bench	AA63CF00050(C)
513	\$691/ea.
305	\$726/ea. (L4)
117	\$883/ea. (L1)

1964 SPORT FURY

This Legendary product features as-original Bison grain inserts with heat sealed upper insert with Bison grain skirts.

Front Buckets	AA64CF00010(C)
101, 503	\$709/pr.
319, 417, 609	\$939/pr. (L1)

*Please specify silver tinsel or color of vinyl cordwelt around seat and back panel inserts at time of order.
*Please specify carpet color of stretch panel at time of order.
*Molded foam is available for this model. See the "Molded Foam" section in this catalog.

Front Bucket Seatback Panels	SK64CF00018(C)
(Pre-sewn vinyl and carpet panels with new boards)	
100, 314, 416, 510	\$204/pr.
606	\$214/pr. (L4)
*Please refer to carpet color selection at time of order.	

Hardtop Rear Bench.....	AA64CF00040(C)
Convertible Rear Bench	AA64CF00050(C)
101, 503	\$658/ea.
319, 417, 609	\$877/ea. (L1)



(C) COLOR CODES:

- (101) - Black with Silver Tinsel welt [Trim Code P4X]
- (319) - Blue (314) w/ Powder Blue (310) Accent & Silver Tinsel welt [Trim Code P4B]
- (417) - Turquoise (416) w/ Light Turquoise (412) Accent & Silver Tinsel welt [Trim Code P4Q]
- (503) - Red (510) w/ Pearl White (202) Accent & Silver Tinsel welt [Trim Code P4R]
- (609) - Copper (606) w/ Rosewood (506) Accent [Trim Code P4U]

1965 SPORT FURY

This Legendary product features as-original heat sealed Cologne grain inserts with chrome accent band & Bison grain skirts.

(C) COLOR CODES:

- (100) - Black [Trim Code P4X]
- (119) - Copper (602) / Black (100) [Trim Code P4U]
- (320) - Navy [Trim Code P4B]
- (414) - Turquoise [Trim Code P4Q]
- (520) - Red [Trim Code P4R]
- (614) - Gold [Trim Code P4Y]

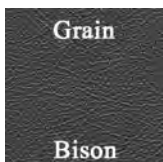
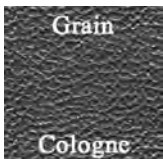

Front Buckets	AA65CF00010(C)
100, 320, 414, 520, 614	\$741/pr.
119	\$1096/pr. (L1)
*Please specify carpet color of stretch panel at time of order.	
*Molded foam is available for this model. See the "Molded Foam" section in this catalog.	
Front Bucket Seatback Panels	SK65CF00018(C)
(Pre-sewn vinyl and carpet panels with new boards)	
100, 320, 414, 520, 614	\$204/pr.
*Please refer to carpet color selection to specify carpet color at time of order.	
Power Seat Rail Carpet Kit	SK65CFM0020(C)
(All colors)	\$91/ea.
*Please refer to carpet color selection at time of order.	
Hardtop Rear Bench	AA65CF00040(C)
Convertible Rear Bench	AA65CF00050(C)
100, 320, 414, 520, 614	\$685/ea.
119	\$1027/ea. (L1)
Rear Speaker Cover with Grommet	SC65CFMP050(C)
(All Colors)	\$98/ea.
Convertible Rear Bench Back Panel	SK64CFMP012
(Board Only)	\$53/ea.
.....	SK6 4CFMP012(C)
(All Colors)	\$81/ea.

1966 SPORT FURY

This Legendary product features as-original heat sealed Cologne grain inserts with Cologne grain skirts and chrome accent band.

(C) COLOR CODES:

- (100) - Black [Trim Code P4X]
- (318) - Blue [Trim Code P4B]
- (420) - Citron [Trim Code P4Y]
- (520) - Red [Trim Code P4R]
- (614) - Gold [Trim Code P4T]

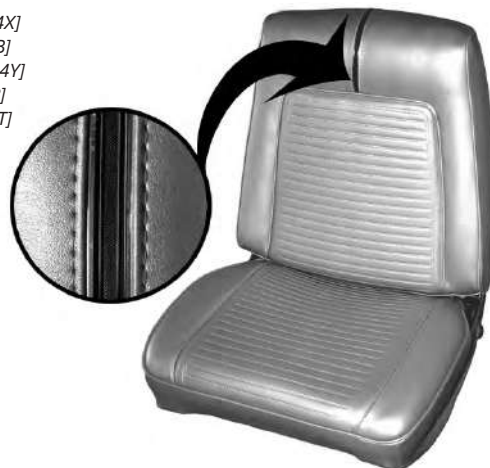
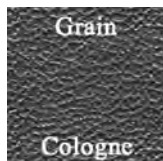

Front Buckets	AA66CF00010(C)
100, 318, 520, 614	\$781/pr.
420	\$820/pr. (L4)
Front Bucket Seatback Panels	SK66CF00018(C)
(Heat sealed vinyl seatback panels with new boards)	
(All colors)	\$133/pr.
Power Seat Rail Carpet Kit	SK65CFM0020(C)
(All colors)	\$91/ea.
*Please refer to carpet color selection at time of order.	
Center Cushion/Armrest	CR66CFM0013(C)
(All colors)	\$163/ea.
*Please refer to carpet color selection at time of order.	
Hardtop Rear Bench	AA66CF00040(C)
Convertible Rear Bench	AA66CF00050(C)
100, 318, 520, 614	\$755/ea.
420	\$793/ea. (L4)
Rear Speaker Cover with Grommet	SC65CFMP050(C)
100, 318, 520, 614	\$98/ea.
420	\$103/ea. (L4)
Convertible Rear Bench Back Panel	SK64CFMP012
(Board Only)	\$53/ea.
.....	SK64CFMP012
100, 318, 520, 614	\$81/ea.
420	\$85/ea. (L4)

1967 SPORT FURY

This Legendary product features as-original Cologne grain inserts with Cologne grain skirts & Bambino grain accent band inlay.

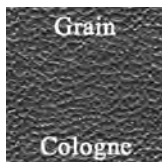

(C) COLOR CODES:

- (100) - Black [Trim Code H6X]
- (202) - Pearl White [Trim Code H6W]
- (321) - Light Blue (318) with Navy (320) Accent [Trim Code H6B]
- (520) - Red [Trim Code H6R]
- (627) - Copper (620) with Dark Copper (626) Accent [Trim Code H6K]

Front Buckets	AA67CF00010(C)
100, 202, 321, 520	\$781/pr.
627	\$1048/pr. (L1)
Front Bucket Seatback Panels	SK67CF00018(C)
(Pre-sewn vinyl & carpet seatback panels with new boards)	
100, 202, 318, 520, 620	\$133/pr.
*Please refer to carpet color selection at time of order.	
Center Cushion/Armrest	CR66CFM0013(C)
100, 202, 318, 520	\$163/ea.
*Please refer to carpet color selection at time of order.	
Rear Bench Hardtop (with speaker cutout)	AA67CFS0048(C)
Convertible	AA67CF00056(C)
100, 202, 321, 520	\$755/ea.
627	\$1017/ea. (L1)
Convertible Top Motor Cover	TP67CFMOTOR
(Cut from black heavy weight panel board)	\$39/ea.



1968 SPORT FURY

This Legendary product features as-original Cologne grain inserts with Cologne grain skirts & Rosette grain accents.

Front BucketsAA68CF00010(C)
100, 202, 350, 431, 527\$761/pr.
231.....\$1529/pr. (L1)
 *Metal emblems *not* included.

Center Cushion/ArmrestCR68CFMP013(C)
100, 202, 332, 430, 520\$163/ea.
230.....\$294/ea. (L1)

Hardtop Rear BenchAA68CF00040(C)
 Convertible Rear BenchAA68CF00050(C)
100, 202, 350, 431, 527\$603/ea.
231.....\$1351/ea. (L1)
 *Metal emblems *not* included.
 *231 Parchment/Ember Gold was not available in convertible model.

Convertible Rear Bench Back PanelSK68CFP0012
100, 202, 332, 430, 520\$81/ea.

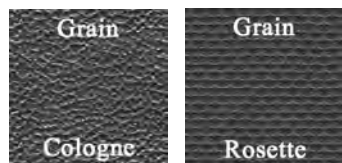

(C) COLOR CODES:

- (100) Black [Trim Codes H6X, S6X]
- (202) Pearl White [Trim Codes H6W, S6W]
- (231) Parchment (230) with Ember Gold (636) Accent [Trim Codes H6Y S6Y]
- (350) Light Blue (332) with Dark Blue (330) Accent [Trim Codes H6B, S6B]
- (431) Dark Green (430) with Light Green (432) Accent [Trim Codes H6F, S6F]
- (527) Red (520) with Maroon (526) Accent [Trim Codes H6R, S6R]

***2-Door Hardtop & Convertible Trim Codes - H6X, H6W, H6Y, H6B, H6F, H6R
 ***2-Door Fast-Top Trim Codes - S6X, S6W, S6Y, S6B, S6F, S6R

1969 SPORT FURY

This Legendary product features as-original Boar grain inserts with Coachman grain skirts.

(C) COLOR CODES:

- (100) Black [Trim Code H6X]
- (134) Platinum [Trim Code H6S]
- (200) White [Trim Code H6W]
- (330) Dark Blue [Trim Code H6D]
- (434) Dark Green [Trim Code H6G]
- (528) Red [Trim Code H6R]
- (650) Saddle [Trim Code H6T]

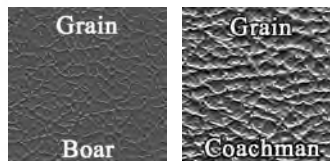

Front BucketsAA69CF00010(C)
100, 200, 330, 434, 528, 650\$761/pr.
134.....\$1529/pr. (L1)

Center Cushion/Armrest (with map pocket).....CR69CM00013(C)
 Center Cushion/Armrest (w/o map pocket)CR69CM00013(C)N
100, 200, 330, 434, 528, 650\$163/ea.
134.....\$273/ea. (L1)

Hardtop Rear BenchAA69CF00040(C)
 Convertible Rear BenchAA69CF00050(C)
100, 200, 330, 434, 528, 650\$603/ea.
134.....\$1351/ea. (L1)
 *434 Green & 650 Saddle were not available in convertible model.

1964 FURY

This Legendary product features as-original 1/16 Rib grain inserts with heat sealed chrome accent band, silver tinsel accent welt & Bison grain skirts.

(C) COLOR CODES:

- (100) Black [Trim Code H4X]
- (312) Dark Blue (333) / Light Blue (314) [Trim Code H4B]
- (422) Dark Turquoise (414) / Light Turquoise (416) [Trim Code H4Q]
- (512) Dark Red (504) / Crimson Red (510) [Trim Code H4R]
- (686) Dark Copper (600) / Copper (606) [Trim Code H4U]

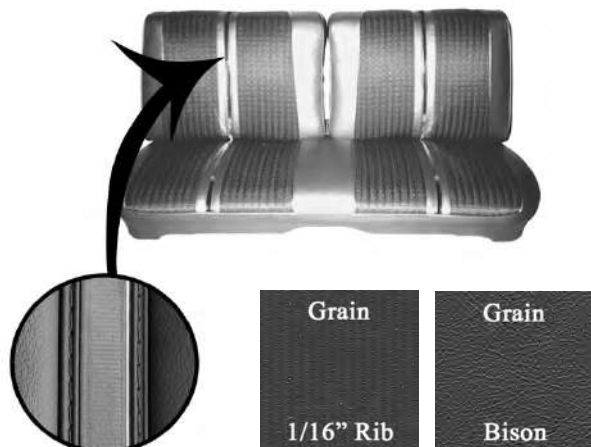

Front Split BenchAA64CF00020(C)
100, 312, 422, 512\$793/ea.
686.....\$833/ea. (L4)

Hardtop Rear BenchAA64CF00080(C)
 Convertible Rear BenchAA64CF00060(C)
100, 312, 422, 512\$595/ea.
686.....\$625/ea. (L4)

1964 FURY "CLOTH STYLE"

This Legendary product features as-original Cloth inserts with heat sealed chrome accent band, silver tinsel accent welt & Bison grain skirts.

(C) COLOR CODES:

- (901) Blue Cloth (900) / Light Blue (314) [Trim Code H1B]
- (903) Fawn Tan Cloth (902) / Fawn Tan (610) [Trim Code H1T]
- (905) Turquoise Cloth (904) / Light Turquoise (416) [Trim Code H1Q]
- (907) Red Cloth (906) / Crimson Red (510) [Trim Code H1R]
- (909) Copper Cloth (908) / Copper (606) [Trim Code H1U]

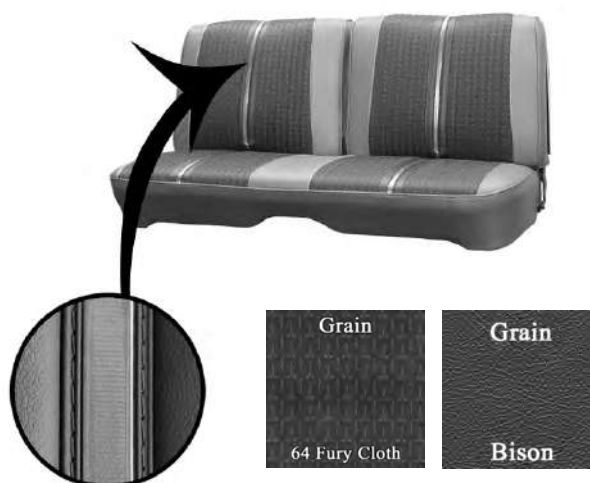

Front Split BenchAA64CFC0020(C)
 (All colors).....\$1162/ea. (L1)

Hardtop Rear BenchAA64CFC0080(C)
 (All colors).....\$983/ea. (L1)

1964 FURY WAGON & FURY 4-DOOR HARDTOP

This Legendary product features as-original 1/16" Rib grain inserts with heat sealed chrome accent band, silver tinsel accent welt & Bison grain skirts.

(C) COLOR CODES:

- (100) Black [Trim Code H4X]
- (312) Dark Blue (333) / Light Blue (314) [Trim Code H4B]
- (422) Dark Turquoise (414) / Light Turquoise (416) [Trim Code H4Q]
- (512) Dark Red (504) / Crimson Red (510) [Trim Code H4R]
- (686) Dark Copper (600) / Copper (606) [Trim Code H4U]
- (697) Dark Fawn Tan (695) / Fawn Tan (610) [Trim Code H4T]



- Front Straight Bench.....AA64CF00023(C)
100, 312, 422, 512.....\$793/ea.
- 686.....\$833/ea. (L4)
- 697.....\$1118/ea. (L1)

- Wagon Rear BenchAA64CF00044(C)
312, 422, 512.....\$595/ea.
- 697.....\$919/ea. (L1)

*100 Black & 686 Dark Copper/Copper were not available in wagon model.

- 4-Door Hardtop Rear Bench.....AA64CF00084(C)
100, 312, 422, 512.....\$595/ea.
- 686.....\$625/ea. (L4)

*697 Dark Fawn Tan/Fawn Tan was not available in 4-Door Hardtop model.

1967 FURY I "CLOTH STYLE"

This Legendary product features as-original Cloth inserts with Cologne grain skirts.

(C) COLOR CODES:

- (761) Blue Cloth (760) / Light Blue (318) [Trim Code E1B]
- (763) Turquoise Cloth (762) / Light Turquoise (416) [Trim Code E1Q]
- (765) Gold Cloth (764) / Light Gold (618) [Trim Code E1T]

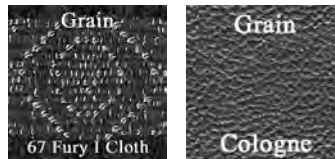

PHOTO N/A
AT TIME OF
PRINTING

- Front Split BenchAA67CF1C020(C)
761, 763.....\$1222/ea. (L1)
- 765.....\$1541/ea. (L1)

- 2-Door Sedan Rear BenchAA67CF1C080(C)
761, 763.....\$951/ea. (L1)
- 765.....\$1233/ea. (L1)

1967 FURY III

This Legendary product features as-original Cologne grain inserts & Cologne grain skirts with Bambino grain accent band inlay.

(C) COLOR CODES:

- (100) Black [Trim Code M4X]
- (202) Pearl White [Trim Code M4W]
- (321) Light Blue (318) with Navy (320) Accent [Trim Code M4B]
- (520) Red [Trim Code M4R]
- (627) Copper (620) with Dark Copper (626) Accent [Trim Code M4K]



- Front Split BenchAA67CF30020(C)
100, 202, 321, 520.....\$797/ea.
- 627.....\$1045/ea. (L1)

- Hardtop Rear Bench.....AA67CF00048(C)
- Convertible Rear BenchAA67CF00056(C)
100, 202, 321, 520.....\$755/ea.
- 627.....\$1017/ea. (L1)

1968 FURY III

This Legendary product features as-original Dorchester grain inserts with Cologne grain skirts.

- Front Split Bench with Center ArmrestAA68CF00030(C)
100, 202, 350, 527\$786/ea.
- 441.....\$1170/ea. (L1)
- 231.....\$1578/ea. (L1)

*Metal buttons not included.

- Headrest Covers.....HC68CLMRW14(C)
100, 202, 332, 430, 520\$110/pr.
- 230.....\$234/pr. (L1)

- Hardtop/Fast Top Rear BenchAA68CF00080(C)
- Convertible Rear BenchAA68CF00060(C)
100, 202, 350, 527\$603/ea.
- 441.....\$994/ea. (L1)
- 231.....\$1351/ea. (L1)

*Metal buttons not included.

- Convertible Rear Seat Back Panel.....SK68CFP0012
100, 202, 332, 430, 520\$77/ea.



(C) COLOR CODES:

- (100) Black [Trim Code M5X]
- (202) Pearl White [Trim Code M5W]
- (231) Parchment (230) with Ember Gold (636) Accent [Trim Code M5Y]
- (350) Light Blue (332) with Dark Blue (330) Accent [Trim Code M5B]
- (441) Antique Green (455) / Dark Green (430) with Light Green (432) Accent [Trim Code M5G]
- (527) Red (520) with Maroon (526) Accent [Trim Code M5R]



1968 FURY III 4-DOOR & SPORT SUBURBAN WAGON

This Legendary product features as-original
Dorchester grain inserts with Cologne grain skirts.

Front Split Bench with Center Armrest	AA68CF00030(C)
100, 350, 527	\$786/ea.
621	\$951/ea. (L1)
454	\$1170/ea. (L1)
231	\$1578/ea. (L1)

*Metal buttons not included.

Headrest Covers	HC68CLMRW14(C)
100, 332, 432, 520	\$110/pr.
230	\$234/pr. (L1)

Wagon Rear Bench	AA68CF00044(C)
100, 350, 527	\$603/ea.
454	\$994/ea. (L1)
621	\$776/ea. (L1)

*Metal buttons not included.

*231 Parchment/Ember Gold was not available in wagon model.

*Rear bench not available for 4-door hardtop & sedan models.

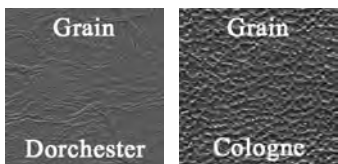

(C) COLOR CODES:

- (100) Black [Trim Code M5X]
- (231) Parchment (230) with Ember Gold (636) Accent [Trim Code M5Y]
- (350) Light Blue (332) with Dark Blue (330) Accent [Trim Code M5B]
- (454) Antique Green (455) / Light Green (432) with Dark Green (430) Accent [Trim Code M5G]
- (527) Red (520) with Maroon (526) Accent [Trim Code M5R]
- (621) Light Fawn (634) with Dark Brown (622) Accent [Trim Code M5T]

1969 FURY III 2-DOOR, 4-DOOR & SPORT SUBURBAN WAGON

This Legendary product features as-original
Boar grain inserts with Coachman grain skirts.

Front Split Bench with Center Armrest	AA69CF00030(C)
100, 200, 351, 435, 528	\$786/ea.
651	\$825/ea. (L4)
134	\$1578/ea. (L1)

*Metal buttons not included.

Headrest Covers	HC69CRW0014(C)
100, 200, 330, 434, 528, 650	\$110/pr.
134	\$234/pr. (L1)

2-Door Hardtop Rear Bench	AA69CF00080(C)
4-Door Hardtop Rear Bench	AA69CF00082(C)
Convertible Rear Bench	AA69CF00060(C)
100, 200, 351, 435, 528	\$603/ea.
651	\$633/ea. (L4)
134	\$1351/ea. (L1)

*Metal buttons not included.

*134 Platinum, 435 Light Green/Dark Green & 651 Bronze/Saddle were not available in convertible model.

*200 White was not available in 4-Door hardtop & sedan model.

*Rear bench not available for sedan & wagon models.

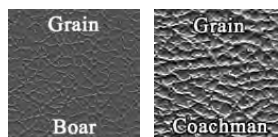

(C) COLOR CODES:

- (100) Black [Trim Code M4X]
- (134) Platinum [Trim Code M4S]
- (200) White [Trim Code M4W]
- (351) Light Blue (332) / Dark Blue (330) [Trim Code M4D]
- (435) Light Green (432) / Dark Green (434) [Trim Code M4G]
- (528) Red [Trim Code M4R]
- (651) Bronze (640) / Saddle (650) [Trim Code M4T]

1957 CHRYSLER 300C "LEATHER STYLE"

This Legendary product features as-original
Leather inserts with Leather skirts.

(C) COLOR CODES:

- (649) Tan [Trim Code 60]



Front Split Bench	AA57CML0020(C)
649	\$1836/ea. (L3)

*Due to complicated construction of this upholstery, we highly recommend that this kit be installed by an experienced professional.

Front Bench Seatback Panel	SK57CML0018(C)
(Heat sealed vinyl on new boards)	
649	\$237/pr. (L3)

Hardtop Rear Bench	AA57CML0080(C)
Convertible Rear Bench	AA57CML0060(C)
649	\$1679/ea.

Convertible Rear Seatback Panel	SK57CML0019(C)
649	\$148/ea. (L3)

1963 CHRYSLER 300

This Legendary product features as-original
heat-sealed Basketweave inserts with Bison skirts.

(C) COLOR CODES:

- (204) Dark White [Trim Code 227]
- (206) Taupe [Trim Code 223]
- (339) Blue [Trim Code 221]
- (406) Turquoise [Trim Code 228]
- (530) Claret Red [Trim Code 225]



PHOTO N/A
AT TIME OF
PRINTING

Front Buckets	AA63CM00010(C)
(All colors)	\$849/pr.

*Molded foam is available for this model. See the "Molded Foam" section in this catalog.
*Specify carpet color of stretch panel at time of order.

Front Bucket Seatback Panels	SK63CM00018(C)
(Pre-sewn vinyl and carpet panels with new boards)	
339, 530	\$211/ea.
204, 206, 406	\$222/ea. (L4)

*Specify carpet color at time of order.

Power Seat Rail Carpet Kit	SK63CFMP020(C)
.....	\$91/ea.

*Specify carpet color at time of order.

Hardtop Rear Bench	AA63CM00040(C)
(All colors)	\$790/ea.

Chrysler, Dodge, Plymouth C-Body

1963 CHRYSLER 300J "LEATHER STYLE"

This Legendary product features as-original
Leather inserts with Bison skirts.

(C) COLOR CODES:

(530) Claret Red [Trim Code 245]

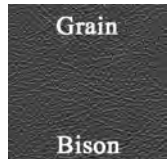

PHOTO N/A
AT TIME OF
PRINTING

Front Buckets	AA63CML0010(C)
530	\$1707/pr. (L3)
<i>*Molded foam is available for this model. See the "Molded Foam" section in this catalog.</i>	
Seatback Panel	SK63CM00018(C)
.....	\$211/ea.
<i>(Pre-sewn vinyl and carpet panels with new boards)</i>	
Power Seat Rail Carpet Kit.....	SK63CFMP02053035
(All colors)	\$91/ea.
Hardtop Rear Bench.....	AA63CML0040(C)
530	\$1850/ea. (L3)

1964 CHRYSLER 300 & 300K

This Legendary product features as-original heat sealed
Basketweave grain inserts with Bison grain skirts.

(C) COLOR CODES:

- (100) Black [Trim Code M4X]
- (202) Pearl White [Trim Code M4W]
- (314) Blue [Trim Code M4B]
- (520) Red [Trim Code M4R]
- (610) Fawn Tan [Trim Code M4T]



Front Buckets	AA64CM00010(C)
100, 202, 314, 520	\$849/pr.
610	\$891/pr. (L4)
<i>*Specify carpet color of stretch panel at time of order.</i>	
<i>*Molded foam is available for this model. See the "Molded Foam" section in this catalog.</i>	
<i>*Bucket seat upholstery is correct for both 2 & 4-Door models.</i>	
Headrest Covers	HC64CM00014(C)
100, 202, 314, 520	\$116/pr.
610	\$122/pr. (L4)
Center Cushion/Armrest.....	CR64CM00013(C)
100, 202, 314, 520	\$163/ea.
610	\$187/ea. (L4)
<i>*Specify carpet color of stretch panel at time of order.</i>	
Power Seat Rail Carpet Kit.....	SK64CFMP020(C)
(All colors)	\$91/ea.
<i>*Specify carpet color at time of order.</i>	
Hardtop Rear Bench (2-Door).....	AA64CM00040(C)
Hardtop Rear Bench (4-Door).....	AA64CM00084(C)
Convertible Rear Bench	AA64CM00050(C)
100, 202, 314, 520	\$790/ea.
610	\$830/ea. (L4)
Convertible Rear Speaker Cover.....	SC64CFMP050(C)
100, 202, 314, 520	\$98/ea.
610	\$103/ea. (L4)
Convertible Rear Bench Back Panel	SK64CFMP012(C) ^{OS1}
(Plain board only)	\$53/ea.
(All colors)	\$81/ea.

1964 CHRYSLER 300 & 300K "LEATHER STYLE"

This Legendary product features as-original Tuck and Roll Leather inserts & collars with Bison grain skirts.

(C) COLOR CODES:

- (100) Black [Trim Code M8X]
- (202) Pearl White [Trim Code M8W]

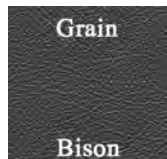

Front Buckets	AA64CML0010(C)
100	\$1448/pr. (L3)
202	\$1707/pr. (L3)
<i>*Molded foam is available for this model. See the "Molded Foam" section in this catalog.</i>	
<i>*Bucket seat upholstery is correct for both 2 & 4-Door models.</i>	
Center Cushion/Armrest.....	CR64CML0013(C)
100	\$198/ea. (L3)
202	\$246/ea. (L3)
<i>*Specify stretch panel carpet color at time of order.</i>	
Power Seat Rail Carpet Kit.....	SK64CFMP020(C)
(All colors)	\$91/ea.
<i>*Specify carpet color at time of order.</i>	
Hardtop Rear Bench (2-Door).....	AA64CML0040(C)
Convertible Rear Bench	AA64CML0050(C)
100	\$1605/ea. (L3)
202	\$1850/ea. (L3)
Convertible Rear Bench Back Panel	SK64CFMP012(C) ^{OS1}
(Plain board only)	\$53/ea.
(All colors)	\$81/ea.



1965 CHRYSLER 300 & 300L

This Legendary product features as-original Basketweave grain inserts with heat sealed upper panels & Cologne grain skirts.

(C) COLOR CODES:

- (100) Black [Trim Codes M4X, P4X]
- (202) Pearl White [Trim Codes M4W, P4W]
- (316) Blue-Black Filled (313) / Blue (322) [Trim Codes M4B, P4B]
- (517) Red-Black Filled (516) / Red (520) [Trim Codes M4R, P4R]
- (605) Dark Brown-Black Filled (607) / Fawn Tan (610) [Trim Codes M4T, P4T]
- (643) Gold-Black Filled (628) / Gold (614) (Requires Sample Approval) [Trim Codes M4L, P4L]

***Chrysler 300 Trim Codes - M4X, M4W, M4B, M4R, M4T, M4L

***Chrysler 300L Trim Codes - P4X, P4W, P4B, P4R, P4T, P4L

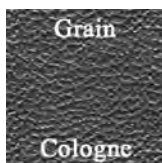

Front Buckets	AA65CM00010(C)
100, 202	\$849/pr.
316, 517, 643	\$1320/pr. (L1)
605	\$1786/pr. (L1)

*All NOS inserts are 2-tone.

*Reproduction inserts also available in single color.

*Specify carpet color of stretch panel at time of order.

*Molded foam is available for this model. See the "Molded Foam" section in this catalog.

*Bucket seat upholstery is correct for both 2 & 4-Door models.

Headrest Covers.....	HC65CM00014(C)
100, 202, 322, 520, 614	\$116/pr.
610	\$122/pr. (L4)

Center Cushion/Armrest	CR65CMN0013(C)
100, 202, 322, 520, 614	\$163/ea.
610	\$187/ea. (L4)

Power Seat Rail Carpet Kit.....	SK65CFMP020(C)
(All colors)	\$91/ea.

*Specify carpet color at time of order.

Hardtop Rear Bench (2-Door).....	AA65CM00040(C)
Convertible Rear Bench	AA65CM00050(C)
100, 202	\$790/ea.
316, 517, 643	\$1085/ea. (L1)
605	\$1426/ea. (L1)

Convertible Rear Speaker Cover.....	SC65CFMP050(C)
100, 202, 322, 520, 614	\$98/ea.
610	\$103/ea. (L4)

Convertible Rear Bench Back Panel	SK64CFMP012(C) 
(Plain board only)	\$53/ea.
(All colors)	\$81/ea.

1965 CHRYSLER 300 & 300L "LEATHER STYLE"

This Legendary product features as-original Tuck & Roll Leather inserts & face with Cologne grain skirts.

(C) COLOR CODES:

- (100) Black [Trim Codes M3X, P3X]
- (520) Red [Trim Codes M3R, P3R]

***Chrysler 300 Trim Codes - M3X, M3R

***Chrysler 300L Trim Codes - P3X, P3R

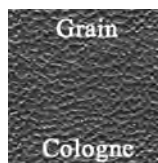

Front Buckets	AA65CML0010(C)
100	\$1448/pr. (L3)
520	\$1707/pr. (L3)

*Specify carpet color of stretch panel at time of order.

*Molded foam is available for this model. See the "Molded Foam" section in this catalog.

*Due to complicated construction of this upholstery, we highly recommend that this kit be installed by an experienced professional.

Headrest Covers.....	HC65CM00014(C)
(All colors)	\$116/pr.

Center Cushion/Armrest.....	CR65CMLN013(C)
100	\$198/ea. (L3)
520	\$246/ea. (L3)

*Specify carpet color at time of order.

Power Seat Rail Carpet Kit.....	SK65CFMP020(C)
(All colors)	\$91/ea.

*Specify carpet color at time of order.

Hardtop Rear Bench (2-Door).....	AA65CML0040(C)
Convertible Rear Bench	AA65CML0050(C)
100	\$1605/ea. (L3)
520	\$1850/ea. (L3)

Convertible Rear Speaker Cover.....	SC65CFMP050(C)
(All colors)	\$98/ea.

Convertible Rear Bench Back Panel	SK64CFMP012(C) 
(Plain board only)	\$53/ea.
(All colors)	\$81/ea.

1966 CHRYSLER 300

This Legendary product features as-original Cologne grain inserts & upper insert with Cologne grain skirts.

(C) COLOR CODES:

- (100) Black [Trim Code M4X]
- (102) Silver [Trim Code M4A]
- (202) Pearl White [Trim Code M4W]
- (320) Navy [Trim Code M4D]
- (520) Red [Trim Code M4R]
- (616) Ginger Tan [Trim Code M4T]

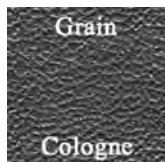

Front Buckets **AA66CM00010(C)**
(All colors).....\$792/pr.

*Bucket seat upholstery is correct for both 2 & 4-Door models.

Front Bucket Seatback Panels **SK66CM00018(C)**
 (Pre-sewn vinyl & carpet back panels with new boards)
(All colors).....\$133/pr.

*Specify carpet color at time of order.

Center Cushion/Armrest..... **CR66CFM0013(C)**
100, 102, 202, 320, 520.....\$163/ea.

*Specify carpet color at time of order.

Hardtop Rear Bench (2-Door)..... **AA66CM00040(C)**
 Convertible Rear Bench **AA66CM00050(C)**
(All colors).....\$681/ea.

Convertible Rear Bench Back Panel **SK64CFMP012(C)** 
(Plain board only).....\$53/ea.
(All colors).....\$81/ea.

1966 CHRYSLER 300 "LEATHER STYLE"

This Legendary product features as-original Leather collars & upper insert with Cologne grain skirts.

(C) COLOR CODES:

- (100) Black [Trim Code M3X]
- (520) Red [Trim Code M3R]

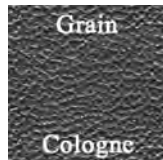

Front Buckets (Reclining passenger)..... **AA66CMLR010(C)**
100.....\$1294/pr. (L3)
520.....\$1640/pr. (L3)

Front Bucket Seatback Panels **SK66CM00018(C)**
 (Pre-sewn vinyl & carpet back panels with new boards)
(All colors).....\$133/pr.

*Specify carpet color at time of order.

Center Cushion/Armrest..... **CR66CML0013(C)**
100.....\$198/ea. (L3)
520.....\$246/ea. (L3)

*Specify carpet color at time of order.

Hardtop Rear Bench (2-Door)..... **AA66CML0040(C)**
 Convertible Rear Bench **AA66CML0050(C)**
100.....\$1128/ea. (L3)
520.....\$1418/ea. (L3)

Convertible Rear Bench Back Panel **SK64CFMP012(C)** 
(Plain board only).....\$53/ea.
(All colors).....\$81/ea.

1966 CHRYSLER 300 "CLOTH STYLE"

This Legendary product features as-original Cologne grain collars & upper insert with Cloth lower insert & Cologne grain skirts.

(C) COLOR CODES:

- (936) Black Cloth (938) / Pearl White (202) [Trim Code M1N]
- (937) Blue Cloth (939) / Navy (320) [Trim Code M1D]

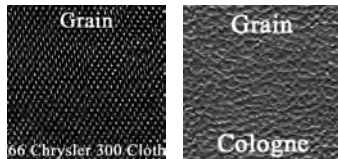

Front Buckets (Reclining passenger)..... **AA66CMCR010(C)**
(All colors).....\$1180/pr. (L1)
 *Bucket seat upholstery is correct for both 2 & 4-Door models.

Front Bucket Seatback Panels **SK66CM00018(C)**
 (Pre-sewn vinyl & carpet back panels with new boards)
202, 320.....\$133/pr.
 *Specify carpet color at time of order.

Center Cushion/Armrest..... **CR66CFM0013(C)**
202, 320.....\$163/ea.
 *Specify carpet color at time of order.

Hardtop Rear Bench (2-Door)..... **AA66CMC0040(C)**
(All colors).....\$947/ea. (L1)



1968 CHRYSLER 300, NEWPORT & NEWPORT CUSTOM

This Legendary product features as-original Oxford grain inserts with Cologne grain skirts.

(C) COLOR CODES:

- (150) Antique Dark Gray (112) / Black (100) [Trim Codes E6X, M6X, L6X]
- (202) Pearl White [Trim Codes E6W, M6W]
- (329) Antique Blue (307) / Dark Blue (330) [Trim Codes E6B, M6B, L6B]
- (436) Antique Green (425) / Dark Green (430) [Trim Codes E6F, M6F, L6F]
- (539) Antique Red (536) / (520) Red [Trim Code E6R, M6R, L6R]

***Newport Trim Codes - E6X, E6W, E6B, E6F, E6R

***Newport Custom Trim Codes - L6X, L6B, L6F, L6R

***Chrysler 300 Trim Codes - M6X, M6W, M6B, M6F, M6R

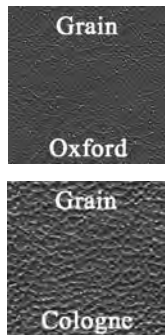

Front Buckets (Non-Reclining passenger).....	AA68CM00010(C)
Front Buckets (Reclining passenger).....	AA68CMR0010(C)
202	\$777/pr.
150, 329, 436, 539	\$1038/pr. (L1)

*Metal emblems not included.

*202 Pearl White made in all Cologne Grain as original.

*202 Pearl White was not available in Newport Custom model.

*Bucket seats were available in both Chrysler 300 & Newport Custom 2 & 4-Door models only.

Headrest Covers.....	HC68CLMRW14(C)
100, 202, 330, 430, 520	\$110/pr.

Center Cushion/Armrest (with map pocket).....	CR68CFMP013(C)
Center Cushion/Armrest (without map pocket).....	CR68CM00013(C)
100, 202, 330, 430, 520	\$163/ea.

Hardtop Rear Bench (2-Door).....	AA68CM00040(C)
Convertible Rear Bench.....	AA68CM00050(C)
202	\$662/ea.
150, 329, 436, 539	\$819/ea. (L1)

*Metal emblems not included.

*202 Pearl White made in all Cologne Grain as original.

*202 Pearl White was not available in Newport Custom model.

*436 Antique Green / Dark Green was not available in convertible models.

*539 Antique Red / Red was not available in Newport 2-Door hardtop model.

1968 CHRYSLER 300 "CLOTH STYLE"

This Legendary product features as-original Cologne grain inserts with Cologne grain skirts.

(C) COLOR CODES:

- (891) Black Cloth (892) / Black (100) [Trim Code M7X]

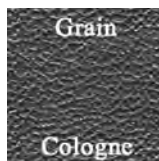

Front Buckets (Reclining passenger).....	AA68CMCR010(C)
891	\$1211/pr. (L1)

*Metal emblems not included.

*Bucket seat upholstery is correct for both 2 & 4-Door models.

Headrest Covers.....	HC68CLMRW14(C)
100	\$110/pr.

Center Cushion/Armrest (with map pocket).....	CR68CFMP013(C)
Center Cushion/Armrest (without map pocket).....	CR68CM00013C)
100	\$163/ea.

Hardtop Rear Bench (2-Door).....	AA68CMC0040(C)
891	\$966/ea. (L1)

*Metal emblems not included.

1969 CHRYSLER 300 & NEWPORT

This Legendary product features as-original Star grain inserts with Coachman grain skirts.

(C) COLOR CODES:

- (100) Black [Trim Codes E6X, M6X]
- (200) White [Trim Codes E6W, M6W]
- (336) Navy [Trim Code M6D]
- (434) Green [Trim Code M6G]
- (650) Saddle [Trim Codes E6T, M6T]

***Newport Trim Codes - E6X, E6W, E6T

***Chrysler 300 Trim Codes - M6X, M6W, M6D, M6G, M6T

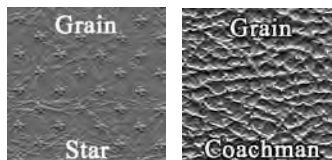

Front Buckets (Non-reclining).....	AA69CM00010(C)
Front Buckets (Reclining passenger).....	AA69CMR0010(C)
(All colors)	\$777/pr.

*Metal emblems not included.

*Bucket seat upholstery is correct for both 2 & 4-Door Chrysler 300 models.

*Reclining passenger seat was only offered in Black for 1969 models.

Center Cushion/Armrest (with map pocket).....	CR69CM00013(C)
Center Cushion/Armrest (without map pocket).....	CR69CM00013(C)N
(All colors)	\$163/ea.

Hardtop Rear Bench (2-Door).....	AA69CM00040(C)
Convertible Rear Bench.....	AA69CM00050(C)
(All colors)	\$662/ea.

*Metal emblems not included.

Chrysler, Dodge, Plymouth C-Body

1969 CHRYSLER 300 "CLOTH STYLE"

This Legendary product features as-original Cloth inserts with Coachman grain skirts.

(C) COLOR CODES:

(689) Tan Cloth (688) / Beige (687) [Trim Code M5L]



Front Buckets (Reclining passenger)..... **AA69CMCR010(C)**
689 \$1237/pr. (L1)
 *Metal emblems not included.
 *Bucket seat upholstery is correct for both 2 & 4-Door Chrysler 300 models.

Center Cushion/Armrest (with map pocket)..... **CR69CM00013(C)**
 Center Cushion/Armrest (without map pocket)..... **CR69CM0013(C)N**
687 \$163/ea.

Hardtop Rear Bench (2-Door)..... **AA69CMC0040(C)**
689 \$951/ea. (L1)
 *Metal emblems not included.

1970 CHRYSLER 300 "CLOTH STYLE"

This Legendary product features as-original Cloth inserts with Coachman grain skirts.

(C) COLOR CODES:

(890) Tan Cloth (889) / Parchment (699) [Trim Code M5L2]



Front Buckets **AA70CMC0010(C)**
890 \$1237/pr. (L1)
 *Metal emblems not included.
 *Bucket seat upholstery is correct for both 2 & 4-Door Chrysler 300 models.

Center Cushion/Armrest (with map pocket)..... **CR69CM00013(C)**
 Center Cushion/Armrest (without map pocket)..... **CR69CM0013(C)N**
699 \$163/ea.

Hardtop Rear Bench (2-Door)..... **AA70CMC0040(C)**
890 \$951/ea. (L1)
 *Metal emblems not included.

1970 CHRYSLER 300 & NEWPORT

This Legendary product features as-original El Paso grain inserts with Coachman grain skirts.

(C) COLOR CODES:

(100) Black [Trim Codes E6X9, M6X9]
 (200) White [Trim Codes E6XW, M6XW]
 (332) Light Blue [Trim Code M6B3]
 (434) Green [Trim Code M6F3]
 (656) Brown [Trim Codes E6T5, M6T5]

***Newport Trim Codes - E6X9, E6XW, E6T5
 ***Chrysler 300 Trim Codes - M6X9, M6XW, M6B3, M6F3, M6T5

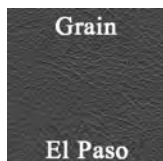

Front Buckets **AA70CM00010(C)**
(All colors) \$777/pr.
 *Metal emblems not included.
 *Bucket seat upholstery is correct for both 2 & 4-Door Chrysler 300 models.

Center Cushion/Armrest (with map pocket)..... **CR69CM00013(C)**
(All colors) \$163/ea.

Convertible Rear Bench **AA70CM00050(C)**
(All colors) \$662/ea.
 *Metal emblems not included.

1970 CHRYSLER 300 HURST EDITION "LEATHER STYLE"

This Legendary product features as-original Tuck & Roll pleated Leather inserts w/ buttons & leather collars - Leather top skirts w/ Coachman grain bottom skirts.

(C) COLOR CODES:

(656) Brown [Trim Code M6T5]



Front Buckets **AA70CMLH010(C)**
656 \$1784/pr. (L3)

Front Bucket Seatback Panels **SK70CM00018(C)**
 (Vinyl bound carpet back panels)
656 \$133/pr.
 *Specify carpet color at time of order.

Center Cushion/Armrest **CR70CMLH013(C)**
656 \$246/ea.

Hardtop Rear Bench **AA70CMLH040(C)**
656 \$1731/ea. (L3)
 *Specify carpet color at time of order.



1971 CHRYSLER 300 & NEWPORT

This Legendary product features as-original Ascot grain inserts & skirts with Coachman grain collars.

(C) COLOR CODES:

- (100) Black [Trim Codes E6X9, S6X9]
- (200) White [Trim Codes E6XW, S6XW]
- (452) Green [Trim Code S6F7]
- (664) Brown [Trim Codes E6T7, S6T7]
- (699) Beige [Trim Code S6L2]

***Newport Trim Codes - E6X9, E6XW, E6T7

***Chrysler 300 Trim Codes - S6X9, S6XW, S6F7, S6T7, S6L2

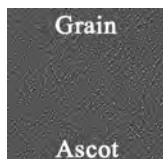

Front Buckets	AA71CM00010(C)
100, 200, 452, 699.....	\$843/pr.
664.....	\$885/pr. (L4)
*Bucket seat upholstery is correct for both 2 & 4-Door models.	
Center Cushion/Armrest (with map pocket).....	CR69CM00013(C)
Center Cushion/Armrest (w/o map pocket)	CR69CM0013(C)N
100, 200, 452, 699.....	\$163/ea.
664.....	\$187/ea. (L4)
Hardtop Rear Bench (2-Door).....	AA71CM00040(C)
100, 200, 452, 699.....	\$730/ea.
664.....	\$767/ea. (L4)

1968 CHRYSLER 300, NEWPORT, TOWN & COUNTRY WAGON

This Legendary product features as-original Oxford grain inserts with Cologne grain skirts with center armrest.

(C) COLOR CODES:

- (150) Antique Dark Gray (112) / Black (100) [Trim Codes E5X, M5X]
- (329) Antique Blue (307) / Dark Blue (330) [Trim Codes E5B, M5B]
- (539) Antique Red (536) / (520) Red [Trim Code E5R]

***Town & Country Wagon & Newport Trim Codes - E5X, E5B, E5R

***Chrysler 300 Trim Codes - M5X, M5B

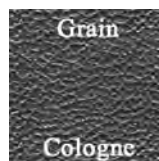

Front Split Bench.....	AA68CM00030(C)
150, 329, 436, 539.....	\$1092/ea. (L1)

1964-68 DODGE/FARGO A-100 VAN & A-100 PICKUP

This Legendary product features as-original heat sealed Bison grain inserts with Bison grain skirts for 1964-1967 models and Coachman grain inserts with Coachman grain skirts for 1968 models.

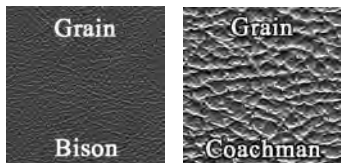

(C) COLOR CODES:

(100) Black

Front Buckets (2" pleat) (1964-67) **AA64CA20010(C)**
 100 \$545/pr.

Front Buckets (2" pleat) (1968 only) **AA68CA20010(C)**
 100 \$545/pr.

☞ Please call for additional color availability

1964-65 DODGE TRUCK CSS "CUSTOM SPORTS SPECIAL"

This Legendary product features as-original heat sealed Bison grain inserts with heat sealed chrome emblem and Bison grain skirts.



(C) COLOR CODES:

(101) Black with Silver Tinsel welt

(C) SEATBACK PANEL COLOR CODES:

(100) Black

Front Buckets **AA64CL00010(C)**
 100 \$725/pr.

☞ Molded foam is available for this model. See the "Molded Foam" section in this catalog.

Front Bucket Seatback Panels **SK64CL00018(C)**
 (Pre-sewn vinyl panels with new boards)
 100 \$193/pr.

Console Carpet Kit **CC62CFPR(C)**
 (80/20 Loop) \$75/kit

1966 DODGE TRUCK CSS "CUSTOM SPORTS SPECIAL"

This Legendary product features as-original Cologne grain inserts and Cologne grain skirts.

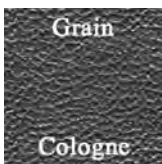

(C) COLOR CODES:

(100) Black

Front Buckets **AA66CL00010(C)**
 100 \$569/pr.

☞ Molded foam is available for this model. See the "Molded Foam" section in this catalog.

Console Carpet Kit **CC62CFPR(C)**
 (80/20 Loop) \$75/kit

1967 DODGE TRUCK CSS "CUSTOM SPORTS SPECIAL"

This Legendary product features as-original heat sealed Cologne grain inserts with Cologne grain skirts.

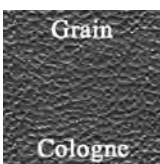

(C) COLOR CODES:

(100) Black

Front Buckets **AA67CL00010(C)**
 100 \$569/pr.

☞ Metal emblems *not* included.

☞ Molded foam is available for this model. See the "Molded Foam" section in this catalog.

Console Carpet Kit **CC62CFPR(C)**
 (80/20 Loop) \$75/kit

1972-73 DODGE TRUCK D/W SERIES

This Legendary product features as-original heat sealed El Paso grain inserts with Coachman grain skirts for conventional cab models only.

(C) COLOR CODES:

(100) - Black [Trim Code KT1]

(250) - Parchment [Trim Code KT4]



Front Buckets	AA73CDT0010(C)
100.....	\$545/pr.
250.....	\$572/pr. (L4)

*Metal emblems not included.

Center Cushion/Armrest.....	CR73CDT0013(C)
(All colors).....	\$142/ea.

1974 DODGE TRUCK D/W SERIES

This Legendary product features as-original heat sealed Oxen grain inserts with Oxford grain skirts for conventional cab models only.

(C) COLOR CODES:

(100) - Black [Trim Code KT1]

(264) - Parchment [Trim Code KT4]

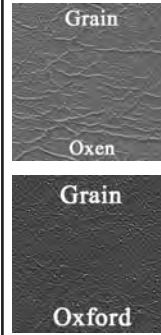

Front Buckets	AA74CDT0010(C)
100.....	\$545/pr.
264.....	\$555/pr. (L4)

*Metal emblems not included.

Center Cushion/Armrest.....	CR74CDT0013(C)
100.....	\$142/ea.
264.....	\$171/ea. (L4)

1975 DODGE TRUCK D/W SERIES

This Legendary product features as-original heat sealed Shallow Elk grain inserts with Oxford grain skirts for conventional cab models only.

(C) COLOR CODES:

(100) - Black [Trim Code KT1]

(267) - Metallic Parchment (266) / Parchment (264) [Trim Code KT4]

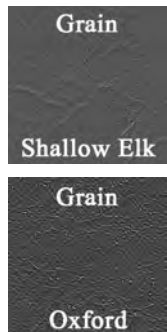

Front Buckets	AA75CDT0010(C)
100.....	\$545/pr.
267.....	\$788/pr. (L1)

*Metal emblems not included.

Center Cushion/Armrest.....	CR74CDT0013(C)
100.....	\$142/ea.
264.....	\$171/ea. (L4)

1976-79 DODGE TRUCK D/W SERIES

Models include: 1976-79 POWER WAGON - 1976-79 WARLOCK - 1976-79 MACHO - 1978 MIDNITE EXPRESS & 1978-79 L.I.L RED EXPRESS

This Legendary product features as-original heat sealed Shallow Elk grain inserts with Oxford grain skirts for conventional cab models only.

(C) COLOR CODES:

(100) - Black [Trim Code KT1] - 1976-1979

(267) - Metallic Parchment / Parchment [Trim Code KT4] - 1976-1977

***Trucks originally equipped with bucket seats would have a KB5 code on the Equipment Identification tag located on the hood.

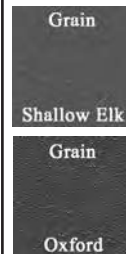

Front Buckets	AA76CDT0010(C)
100.....	\$545/pr.
267.....	\$788/pr. (L1)

*Metal emblems not included.

Center Cushion/Armrest.....	CR76CDT0013(C)
100.....	\$142/ea.
264.....	\$171/ea. (L4)

Back Wall Carpet Kit (Cut-pile) 	SK78CDT00210(C)
(All colors).....	\$204/ea.

*Please refer to carpet color selection at time of order.



1978 DODGE TRUCK D/W SERIES

Models include: POWER WAGON & LI'L RED EXPRESS

This Legendary product features as-original Diamond Waffle grain inserts with Oxford grain skirts for conventional cab models only.

(C) COLOR CODES:

- (100) - Black [Trim Code KT1]
- (548) - Red [Trim Code KT6]



Front Bench **AA78CDT0020(C)**
(All colors)..... \$574/ea.

Back Wall Carpet Kit (Cut-pile)  **SK78CDT00210(C)**
(All colors)..... \$204/ea.

**Please refer to carpet color selection at time of order.*

1979 DODGE TRUCK D/W SERIES

Models include: POWER WAGON & LI'L RED EXPRESS

This Legendary product features as-original El Paso grain inserts with El Paso grain skirts for conventional cab models only.

(C) COLOR CODES:

- (100) - Black [Trim Code KT1]
- (548) - Red [Trim Code KT6]

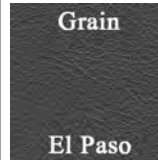

Front Bench **AA79CDT0020(C)**
(All colors)..... \$574/ea.

Back Wall Carpet Kit (Cut-pile)  **SK78CDT00210(C)**
(All colors)..... \$204/ea.

**Please refer to carpet color selection at time of order.*

SEAT SPRING KIT 1962-65 A, B & C-BODY Bucket Seat Top & Bottom Spring Kit

Each kit consists of (4) individual seat top springs and (1) seat bottom spring assembly.

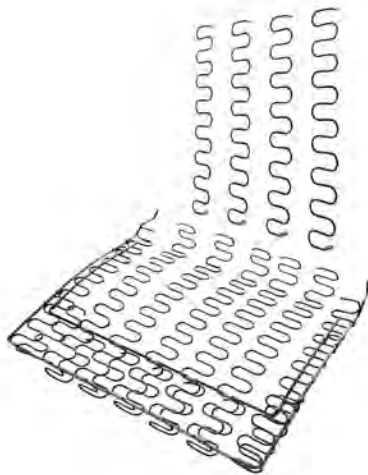

SA62CABC \$159.00/kit
 (1) Kit does (1) complete bucket seat
 (2) Kits must be ordered to do a pair of bucket seats
 Sold as a top and bottom kit only

UNIVERSAL COIL SPRINGS Bench Seat & Rear Seat

Universal coil seat springs used in automotive interiors to absorb shock and give added resilience to the seat. Used in all makes and models dating back to the 1930's.

NOTE: When choosing an upholstery coil seat spring, measure the overall height when not under pressure.



SACOIL4 (4" Tall - 13 Gauge)..... \$7.00/ea.
SACOIL4.5 (4.5" Tall - 13 Gauge) \$7.00/ea.
SACOIL5 (5" Tall - 12 Gauge)..... \$7.00/ea.
SACOIL5.5 (5.5" Tall - 12 Gauge) \$7.00/ea.

 Applications Include: Front Split Bench Seats, Front Straight Bench Seats, Hardtop Rear Seats, Sedan/Coupe Rear Seats & Convertible Rear Seats

3 3/8" INTERLOCKING SPRING

Long Bench Seat & Rear Seat

3 3/8" long spring used in automotive interiors to tie together the coil seat springs which absorb shock and give added resilience to the seat. Used in all makes and models dating back to the 1930's



SASPRING \$2.00/ea.

 Applications Include: Front Split Bench Seats, Front Straight Bench Seats, Hardtop Rear Seats, Sedan/Coupe Rear Seats & Convertible Rear Seats

SEATBACK BOARDS

Seatback boards for 1963 300/300J. These boards are placed on the front of the rear seat bottom frame before installing upholstery. Serves as a kick panel board to protect upholstery from tearing if kicked by rear seat passengers.

SK63CM00012
('63 300/300J Bench) \$25.00/pr.



CENTER ARMREST HINGE WASHER



Side hinge washers made of die-cut polypropylene for bucket seat models with optional center armrest. These washers protect the vinyl from wear when the armrest is folded in the up or down position.

HG66WASHER \$ 4.00/pr.



MOLDED FOAM AND FOAM ACCESORIES

 facebook.com/legendaryautointeriors
 twitter.com/legendaryautoin

 www.legendaryautointeriors.com
 instagram.com/legendaryautointeriorsltd
 youtube.com/user/legendaryauto

**INSTALLATION KITS
FRONT BUCKET SEATS
All 1960-79 Dodge/Chrysler/Plymouth**



INSTALLATION-KIT1 ⁰⁵¹.....\$29.00/ea.
 ☞ Kit includes: 3 yards of burlap, 30 feet of paper coated listing wire, 2.5 yards of 2 inch wide felt & a dust mask.

**HARDTOP AND CONVERTIBLE
REAR SEATS
All 1966-74 Dodge/Chrysler/Plymouth**



INSTALLATION-KIT2 ⁰⁵¹.....\$279.00/ea.
 ☞ Kit includes: (1) 30"x70" 1 1/2" thick foam, (1) 10lb. roll of cotton, 4 yards of burlap, 12 feet of paper coated listing wire, 2 yards of muslin, (1) 3 1/2" x 64" Wire Edge Reinforced Burlap Cotton Support Band & a dust mask.

**INSTALLATION KITS CONT.
SPLIT BENCH & FULL BENCH
FRONT SEATS
All 1962-74 Dodge/Chrysler/Plymouth
*With & Without Center Armrest**



INSTALLATION-KIT4 ⁰⁵¹.....\$279.00/ea.
 ☞ Kit includes: (1) 30"x70" 1 1/2" thick foam, (1) 10lb. roll of cotton, 4 yards of burlap, 12 feet of paper coated listing wire, 2 yards of muslin, 3 yards of 2 inch wide felt, (1) 3 1/2" x 64" Wire Edge Reinforced Burlap Cotton Support Band & a dust mask.

**HARDTOP AND CONVERTIBLE
REAR SEATS
1962-65 Dodge/Chrysler/Plymouth
*With & Without Center Speaker Assembly**



INSTALLATION-KIT12 ⁰⁵¹.....\$279.00/ea.
 ☞ Kit includes: (1) 30"x70" 1 1/2" thick foam, (1) 10lb. roll of cotton, 4 yards of burlap, 12 feet of paper coated listing wire, 2 yards of muslin, (1) 6" x 64" Wire Edge Reinforced Burlap Cotton Support Band & a dust mask.

HOG RING PLIER KITS

Standard Hog Ring Plier Kit
TAHOG.....\$15.00/ea.
 ☞ Kit contains pliers and enough hog rings for a front or rear installation only.

Deluxe Hog Ring Plier Kit
TAHOGHVY.....\$39.00/ea.
 ☞ Kit contains heavy duty pliers and enough hog rings for a complete front and rear installation.

Hog Rings (Pkg/200)
TAHOGRING200.....\$ 5.00/pk.

**INSTALLATION, FOAM &
COTTON ACCESSORIES**

Cotton Batting (1 Roll) ⁰⁵²
TACOTTONROLL.....\$ 48.00/ea.
 ☞ 1 Roll consists of 10 lbs.
 ☞ Must be used in conjunction with Legendary muslin.

Muslin (1 yard)
TAYDMUSLIN.....\$ 3.00/yd.
 ☞ Must be used in conjunction with Legendary cotton batting.

High Density Foam
TAFOAM1 (1.5" thick x 12" x 12").....\$20.00/ea.
TAFOAM2 (1.5" thick x 24" x 24").....\$38.00/ea.
TAFOAM3 (1.5" thick x 30" x 70") ⁰⁵¹.....\$82.00/ea.

Burlap (36" wide)
TABURLAP.....\$ 3.00/yd.

Paper Coated Wire
TAPAPERWIRE.....\$ 2.50/ft.

MOLDED FOAM KITS

1960-65 B & C-BODY BUCKET SEAT FOAM



1960-65 molded foam for all B & C-Body models with bucket seats. Sets consist of a pair of (2) front seat tops and (2) front seat bottoms.

MF60ABCSET ⁰⁵².....\$339.00/set
 ☞ Requires minimal to moderate modification on some models during installation.
 ☞ Professional installation is highly recommended. Please see our installation services page located in the back of this catalog.
 ☞ Bucket seat foam will not work for Chrysler 300 rear bucket seats.

1963-69 A-100 VAN & SUPERSTOCK BUCKET SEAT FOAM

PHOTO N/A AT TIME OF PRINTING

Molded foam kit for 1963-69 A-100 Van, 1964, 65 & 68 Super Stock. Sets consist of a pair of (2) front seat tops and (2) front seat bottoms.

MF64CSS ⁰⁵².....\$369.00/set
 ☞ Requires minimal to moderate modification on some models during installation.
 ☞ Professional installation is highly recommended. Please see our installation services page located in the back of this catalog.



Providing the automotive industry
with the world's highest quality
soft trim products and services
RIGHT HERE AT HOME

**STILL ASSEMBLED AND
MADE IN THE** ★★★★★
USA 

THERE REALLY IS A DIFFERENCE!!



Legendary
AUTO INTERIORS LTD.

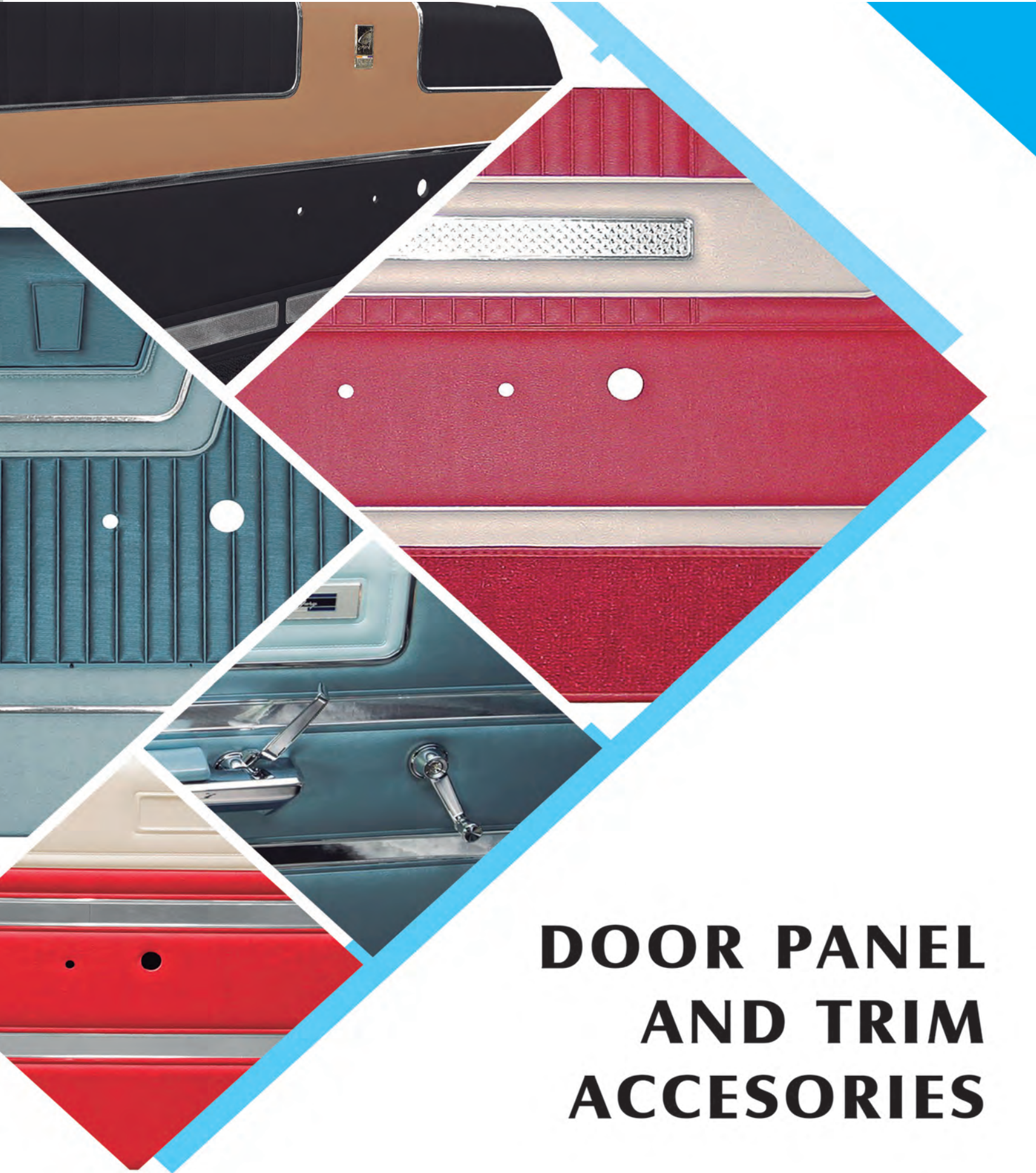

www.legendaryautointeriors.com





DOOR PANEL AND TRIM ACCESORIES

 facebook.com/legendaryautointeriors
 twitter.com/legendaryautoin

 www.legendaryautointeriors.com
 instagram.com/legendaryautointeriorsltd
 youtube.com/user/legendaryauto

1963 SPORT FURY BUCKET STYLE

This Legendary product features as-original Die-electrically heat sealed Pinpoint grain upper and Bison grain middle with carpet lower. Special cutout area in filler board to accommodate armrest base. Padded Multi-Level Construction 3-Dimensional Panel.

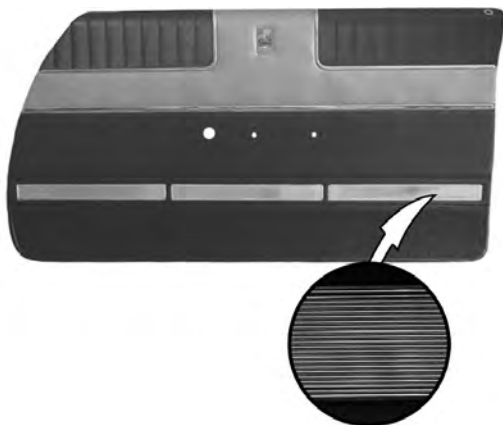
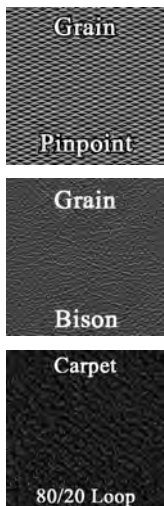

(C) COLOR CODES:

(117) Black (100) w/ Copper (604) Accent
(305) Blue (302) w/ Light Blue (304) Accent
(513) Crimson Red (510) w/ Dark White (204) Accent

Front Panels (Unassembled).....	DO63CF00010(C)
513.....	\$725/pr.
305.....	\$761/pr. (L4)
117.....	\$888/pr. (L1)

☞ Please refer to carpet color selection at time of order.
☞ Customer must reuse original metal trim.

Front Panels (Pre-assembled).....	DO63CF00010(C)-PA
513.....	\$951/pr.
305.....	\$999/pr. (L4)
117.....	\$1109/pr. (L1)

☞ Please refer to carpet color selection at time of order.
☞ Customer must reuse original metal trim.
☞ Includes original style upper metal rail & window felt strip.

Hardtop Rear Panels.....	DO63CF00040(C)
513.....	\$321/pr.
305.....	\$337/pr. (L4)
117.....	\$433/pr. (L1)

☞ Please refer to carpet color selection at time of order.
☞ Customer must reuse original metal trim.

Convertible Rear Panels (w/o rear armrest).....	DO63CF00050(C)
Convertible Rear Panels (with rear armrest).....	DO63CF00L50(C)
513.....	\$277/pr.
305.....	\$291/pr. (L4)
117.....	\$357/pr. (L1)

☞ Please refer to carpet color selection at time of order.
☞ Customer must reuse original metal trim.

1964 SPORT FURY BUCKET STYLE

This Legendary product features as-original Die-electrically heat sealed Bison grain vinyl with chrome accents. Special cutout area in filler board to accommodate armrest base. Padded Multi-Level Construction 3-Dimensional Panel.

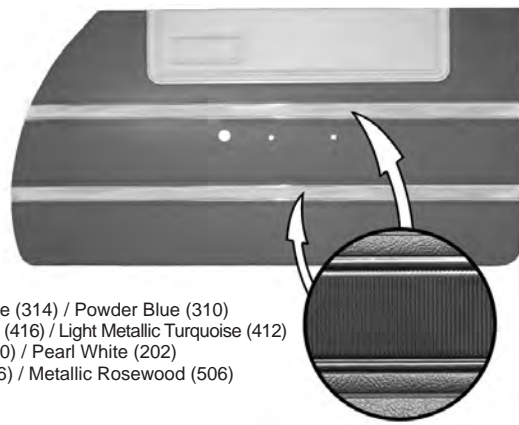

(C) COLOR CODES:

(100) Black
(319) Light Metallic Blue (314) / Powder Blue (310)
(417) Metallic Turquoise (416) / Light Metallic Turquoise (412)
(511) Crimson Red (510) / Pearl White (202)
(609) Dark Copper (606) / Metallic Rosewood (506)

Front Panels (Unassembled).....	DO64CF00010(C)
100, 511.....	\$704/pr.
319, 417, 609.....	\$855/pr. (L1)

☞ Require (16) door clips per panel.

Front Panels (Pre-assembled).....	DO64CF00010(C)-PA
100, 511.....	\$936/pr.
319, 417, 609.....	\$1128/pr. (L1)

☞ Require (16) door clips per panel.

☞ Includes original style upper metal rail & window felt strip.

Hardtop Rear Panels.....	DO64CF00040(C)
100, 511.....	\$309/pr.
319, 417, 609.....	\$408/pr. (L1)

☞ Require (6) door clips per panel.

Convertible Rear Panels.....	DO64CF00050(C)
100, 511.....	\$265/pr.
319, 417, 609.....	\$348/pr. (L1)

☞ Require (6) door clips per panel.



1964 FURY BENCH STYLE

This Legendary product features as-original Die-electrically heat sealed Bison grain vinyl. Special cutout area in filler board to accommodate armrest base. Padded Multi-Level Construction 3-Dimensional Panel.



Grain

(C) COLOR CODES:

- (100) Black
- (312) Dark Blue (333) / Metallic Blue (314)
- (422) Dark Metallic Turquoise (414) / Metallic Turquoise (416)
- (512) Dark Red (504) / Crimson Red (510)
- (658) Dark Metallic Brown (608) / Metallic Fawn (610)
- (686) Chestnut (600) / Copper (606)

Bison

Front Panels (Unassembled).....	DO64CF00020(C)
100, 312, 422, 512.....	\$704/pr.
686.....	\$739/pr. (L4)
658.....	\$936/pr.

☞ Customer must reuse original metal trim.

Front Panels (Pre-assembled).....	DO64CF00020(C)-PA 
100, 312, 422, 512.....	\$936/pr.
686.....	\$983/pr. (L4)
658.....	\$1178/pr.

☞ Customer must reuse original metal trim.
☞ Includes original style upper metal rail & window felt strip.

Hardtop Rear Panels.....	DO64CF00080(C)
100, 312, 422, 512.....	\$309/pr.
686.....	\$324/pr. (L4)
658.....	\$470/pr.

☞ Customer must reuse original metal trim.

Convertible Rear Panels.....	DO64CF00060(C)
100, 312, 422, 512.....	\$265/pr.
686.....	\$278/pr. (L4)

☞ Customer must reuse original metal trim.
☞ Color code 658 was not available in a convertible model.

1965 SPORT FURY BUCKET STYLE

This Legendary product features as-original Die-electrically heat sealed Cologne grain upper and Bison grain middle with carpeted lower. Special cutout area in filler board to accommodate armrest base. Padded Multi-Level Construction 3-Dimensional Panel.

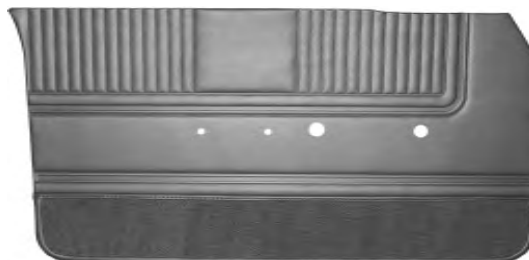

Grain

Grain

(C) COLOR CODES:

- (100) Black
- (119) Copper (602) / Black (100)
- (320) Metallic Navy
- (414) Dark Metallic Turquoise
- (520) Metallic Red
- (614) Gold

Cologne

Bison

Front Panels.....	DO65CF00010(C)
100, 320, 414, 520, 614.....	\$702/pr.
119.....	\$925/pr. (L1)

☞ Please refer to carpet color selection at time of order.
☞ Require (16) door clips per panel.

Hardtop Rear Panels.....	DO65CF00040(C)
100, 320, 414, 520, 614.....	\$309/pr.
119.....	\$470/pr. (L1)

☞ Please refer to carpet color selection at time of order.
☞ Require (6) door clips per panel.

Convertible Rear Panels.....	DO65CF00050(C)
100, 320, 414, 520, 614.....	\$265/pr.
119.....	\$372/pr. (L1)

☞ Please refer to carpet color selection at time of order.
☞ Require (6) door clips per panel.
☞ Professional installation recommended.

1964 POLARA 500 BUCKET STYLE

This Legendary product features as-original Die-electrically heat sealed Bison grain vinyl with carpeted lower section. Special cutout area in filler board to accommodate armrest base. Padded Multi-Level Construction 3-Dimensional Panel.

Front Panels (Unassembled).....	DO64CP00010(C)
100, 124, 511.....	\$725/pr.
611.....	\$761/pr. (L4)
311, 417.....	\$943/pr. (L1)
413.....	\$1022/pr. (L1)

☞ Please refer to carpet color selection at time of order.
☞ Customer must reuse original metal trim.

Front Panels (Pre-assembled).....	DO64CP00010(C)-PA 
100, 124, 511.....	\$951/pr.
611.....	\$999/pr. (L4)
311, 417.....	\$1178/pr. (L1)
413.....	\$1221/pr. (L1)

☞ Please refer to carpet color selection at time of order.
☞ Customer must reuse original metal trim.
☞ Includes original style upper metal rail & window felt strip.

Hardtop Rear Panels.....	DO64CP00040(C)
100, 124, 511.....	\$321/pr.
611.....	\$337/pr. (L4)
311, 417.....	\$471/pr. (L1)
413.....	\$520/pr. (L1)

☞ Please refer to carpet color selection at time of order.
☞ Customer must reuse original metal trim.

Convertible Rear Panels.....	DO64CP00050(C)
100, 124, 511.....	\$277/pr.
611.....	\$291/pr. (L4)
311, 417.....	\$382/pr. (L1)
413.....	\$422/pr. (L1)

☞ Please refer to carpet color selection at time of order.
☞ Customer must reuse original metal trim.

Grain

Bison

Carpet

80/20 Loop

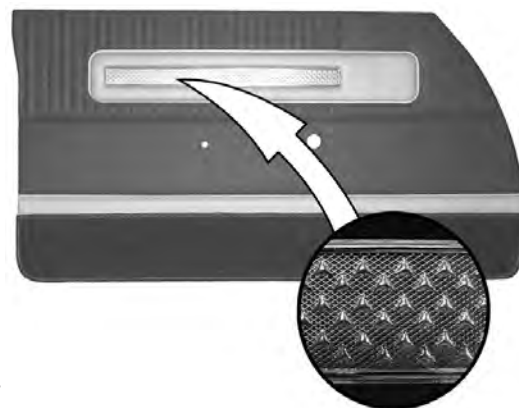

(C) COLOR CODES:

- (100) Black
- (124) Black (100) w/ Pearl White (202) Accent
- (311) Light Metallic Blue (314) w/ Powder Blue (310) Accent
- (413) Light Metallic Olive (410) w/ Pearl White (202) Accent
- (417) Met Turquoise (416) w/ Light Met Turquoise (412) Accent
- (511) Crimson Red (510) w/ Pearl White (202) Accent
- (611) Metallic Fawn (610) w/ Pearl White (202) Accent

ARMREST PADS



1964-66 B-Body reproduction front armrest pads feature the correct Bison grain finish.

AP64ABC01LR (Black)..... \$79.00/pr.
 ☞ These pads may also fit some C-Body models.



1966-70 C-Body, 1966-67 B-Body & 1966-1970 Charger repro-duction 13" front armrest pads.

- AP66CRWX-FRT100 (Black)** \$109.00/pr.
 - AP66CRWX-FRT154 (Charcoal)**..... \$109.00/pr.
 - AP66CRWX-FRT200 (White)**..... \$109.00/pr.
 - AP66CRWX-FRT202 (Pearl White)** \$109.00/pr.
 - AP66CRWX-FRT318 (Light Met. Blue)**.. \$109.00/pr.
 - AP66CRWX-FRT320 (Met. Navy)** \$109.00/pr.
 - AP66CRWX-FRT330 (Dark Met. Blue)**.. \$109.00/pr.
 - AP66CRWX-FRT332 (Light Met. Blue)**.. \$109.00/pr.
 - AP66CRWX-FRT338 (Bright Blue)**..... \$109.00/pr.
 - AP66CRWX-FRT420 (Citron)**..... \$109.00/pr.
 - AP66CRWX-FRT430 (Dark Met. Green)**.. \$109.00/pr.
 - AP66CRWX-FRT434 (Dark Met. Green)**.. \$109.00/pr.
 - AP66CRWX-FRT520 (Met. Red)** \$109.00/pr.
 - AP66CRWX-FRT528 (Red)**..... \$109.00/pr.
 - AP66CRWX-FRT540 (Burnt Orange)**.. \$109.00/pr.
 - AP66CRWX-FRT614 (Gold)** \$109.00/pr.
 - AP66CRWX-FRT620 (Copper)**..... \$109.00/pr.
 - AP66CRWX-FRT630 (Gold)** \$109.00/pr.
 - AP66CRWX-FRT636 (Ember Gold)**.... \$109.00/pr.
 - AP66CRWX-FRT650 (Saddle)** \$109.00/pr.
 - AP66CRWX-FRT656 (Brown)** \$109.00/pr.
 - AP66CRWX-FRT670 ("Dukes" Tan)**.... \$109.00/pr.
- ☞ 13" armrest pads may also fit some C-Body models.
 ☞ Some 1966-67 B-Body models used 9 1/2" front armrest pads. If your armrests measure 9 1/2" please use 1968-70 armrest pad part number at time of order.

ARMREST BASES



1964-65 C-Body reproduction 15" armrest bases. Bases feature correct smooth chrome finish.

AP64ABC-BASE..... \$99.00/pr.

DOOR PANEL CLIPS



Door panel clips for all models except E-Body models.

DOCLIP..... \$1.00/ea.

ASH TRAYS

Reproduction ash trays and bezels for 1966-70 B & C-Body rear armrest, and 1970 E-Body rear side panels & 71-74 B & E-Body rear consoles.

1966-74 B, C & E-Body
AT66BE..... \$59.00/ea.

WINDOW CRANK SPACERS



Front and rear window crank spacers for all 1968-74 B & C-Body models

1968-74 B & C-Body (all models)
CK68SPACER..... \$5.00/ea.
 ☞ Will work for front and rear windows on A, B & C-Body models.
 ☞ Will only work for front windows on E-Body models.

WINDOW CRANK SCREWS



Chrome plated window crank screws with hex like head for all 1968-74 B & C-Body models.

CK68SCREW..... \$2.00/ea.
 ☞ Use (4) per car.

VENT WINDOW CRANKS

1967 B & C-Body (all models)
CK67ABC-VENT..... \$29.00/ea.

WINDOW CRANKS



1963-66 B & C-Body window cranks

CK63ABC-WNDW \$29.00/ea.



1963-66 B & C-Body quarter glass window cranks

CK63ABC-QTR..... \$29.00/ea.



Reproduction front and rear window cranks for all 1967-74 B & C-Body models. Chrome plated with black knob.

1967 B & C-Body (all models)
CK67ABC-WNDW \$29.00/ea.
 ☞ Correct for front and rear windows.

1968-74 B & C-Body (all models)
CK68C-WNDW..... \$59.00/pr.
 ☞ Correct for front and rear windows.
 ☞ Screws and washers not included.

1968-74 B & C-Body (all models)
CK68C-WNDW1..... \$69.00/pr.
 ☞ Correct for front and rear windows.
 ☞ Screws and thin washers included in this kit.



A collage of car interior accessories. The top left shows a black floor mat with the 'Dodge' logo in white. Below it is another black floor mat with the 'Warlock' logo in gold. To the right is a large, dark blue carpet with a clear plastic pocket. Below that is a red, textured carpet. At the bottom left is a close-up of a car's center console with a gear shifter and handbrake.

Dodge

Warlock

CARPETS, FLOORMATS AND ACCESORIES

 facebook.com/legendaryautointeriors

 twitter.com/legendaryautoin

 www.legendaryautointeriors.com

 instagram.com/legendaryautointeriorsltd

 youtube.com/user/legendaryauto



MODEL SPECIFIC CARPET

Legendary brand molded carpets utilize the heaviest face weight cutpile and loop carpet combined with an extra heavy poly coated backing that provides for an accurate and sharply detailed mold formed area. Surged edges and accurately die cut and applied 40oz. felt underlayment is the finishing touch to our vehicle specific carpets.

Bound and Surged Edges

Both Legendary cutpile and loop molded carpets have a heavy duty bound and surged edge that provides for an easy installation and clean appearance.



Underlayment Padding

Legendary molded carpets are made with a 40 oz. felt underlayment padding. All padding is trimmed around seat track mounts, seat belt holes and covers the most area than any carpet in the industry!



80/20 LOOP CARPET COLOR SELECTOR (c)

01 BLACK	03 RED	04 AQUA	05 DARK TEAL	06 FORD BLUE	07 DARK BLUE	08 TEAL	09 SHADE 13 BLUE
10 BRIGHT BLUE	11 MEDIUM BLUE	12 GREEN	13 DARK GREEN	14 DARK OLIVE GREEN	15 BLUE GREEN	16 MOSS GREEN	21 MEDIUM RED
22 BURNT ORANGE	24 ROSE BEIGE	25 DARK BROWN	26 SADDLE	27 LT/MEDIUM SADDLE	28 DARK COPPER	29 DARK SADDLE	31 MAROON
32 GOLD	33 DARK GOLD	34 FAWN	35 RED TUXEDO	36 BLUE TUXEDO	37 AQUA TUXEDO	38 LIGHT GREEN	39 ORANGE
40 PLUM	41 SUNSET GLOW	42 SILVER MINK	44 CORAL	45 EMBER GLOW	46 IVY GOLD	47 FAWN TUXEDO	48 SILVER
49 GUNMETAL GRAY	50 PARCHMENT	51 MIDNIGHT BLUE	53 GOLD TUXEDO	54 COPPER TUXEDO	55 OLIVE TUXEDO	81 CHARCOAL	

****36oz. JUTE PADDING INCLUDED WHERE PADDING WAS ORIGINAL.**

****VINYL BOUND EDGE WHERE THE FRONT AND REAR SECTIONS OF THE CARPET OVERLAP.**

****COLOR MATCHED ORIGINAL HEEL PAD ACCURATELY APPLIED USING THE SAME METHOD AS OEM.**

****MEETS OR EXCEEDS OEM SPECIFICATIONS.**

****DIMMER SWITCH GROMMET INCLUDED.**

****COLOR SAMPLES ARE AVAILABLE FOR COLORS OTHER THAN BLACK.**

****DYE LOTS WILL VARY +/- 10%. THIS IS COMMON IN THE CARPET INDUSTRY. CUSTOMERS ARE ENCOURAGED TO ORDER ALL CARPETED PRODUCTS AT THE SAME TIME TO ENSURE MATCHING DYE LOT.**

****FOR YEARS AND MODELS NOT LISTED PLEASE CALL OUR SALES DEPARTMENT AT 800-363-8804**

CUTPILE

CARPET COLOR SELECTOR (c)

801 BLACK	802 BLUE	807 DK. GRAY	808 TURQUOISE	810 BROWN	812 ROYAL BLUE	815 RED	818 OCEAN BLUE
819 DK. BLUE	820 SADDLE	821 TAUPE	825 MAROON	830 BUCKSKIN	835 FIRETHORNE	839 FED. BLUE	840 NAVY
849 JADE GREEN	850 CHAMOIS	852 SILVER	854 CARAMEL	857 MED. GRAY	869 WILLOW GREEN	871 SANDALWOOD	875 OXBLOOD
877 DOVE GRAY	885 LT. MAROON	897 CHARCOAL	1251 ALMOND	1804 SILVER	4033 MIDNIGHT BLUE	4305 OXBLOOD	4640 SADDLE
4643 POWDER BLUE	4666 SMOKE	4880 SAGE GREEN	7037 CAMEL TAN	7039 CARMINE	7075 OYSTER	7099 ANTELOPE	7130 DK. BLUE
7140 MED. SADDLE	7295 MEDIUM DOESKIN	7298 MAPLE	7500 BRIAR BROWN	7623 MEDIUM SAND GRAY	7701 GRAPHITE	7766 BLUE	8046 SILVER
8075 MED. GRAY	8082 LT. CRYSTAL BLUE	8384 DESERT TAN	8801 FLAME RED	8991 FORD SANDALWOOD	9006 LIGHT MOCHA	9196 MED. OPAL	9197 MEDIUM MOCHA
9199 SMOKE	9229 STEEL BLUE	9304 REGATTA BLUE	9577 MEDIUM DARK OAK	9777 BEIGE	9779 MED. GRAY	9779 TORCH RED	2000 CHROME YELLOW
2947-A RED	2005 HUGGER ORANGE	1998 ROYAL PURPLE	2003 LIMELIGHT GREEN	2004 ELECTRIC BLUE	8500 WHITE	1999 POWER PUMPKIN	2001 FUCHSIA

*For colors other than BLACK, a clean, non-faded sample may be helpful to assure a correct color match when ordering. Samples are available upon request. Dye lots will vary +/- 10%. This is common to industry standards and must be understood by the customer on all colors with or without sample approval. Customers are encouraged to order all carpeted products at one time to ensure the best dye lot matching. Carpeted items include: Seat back panels, Console carpet kits and certain model door panel carpet trim.

CARPET (NYLON LOOP)

The finest available today. Two-piece pre-molded shape made with an original specification blend of 100% Nylon. All carpets include 36oz. jute padding on the backside, dimmer switch grommet, color matched original style heel pad and vinyl bound edge where the front and rear sections overlap. Carpet kits are not shipped with pre-cut holes and must be done during installation of carpet. Some other minor trimming may be needed.

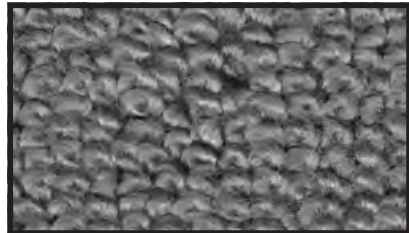

Loop Style

CUT-PILE CARPET

Correct cut pile nylon carpet for 1972 and later cars and trucks. All carpets include 36oz. jute padding on the backside, dimmer switch grommet, color matched original style heel pad and vinyl bound edge where the front and rear sections overlap. Carpet kits not shipped with pre-cut holes and must be done during installation of carpet. Colors other than black require sample approval. Please call for samples.

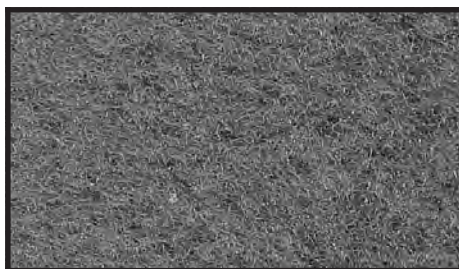

Cut-Pile Style

C-BODY MODELS

- 1972-75 C-Body** ⁰⁵²
CA70CA(C)P (2-door/Automatic) \$275.00/ea.
CA70CS(C)P (2-door/Manual) \$275.00/ea.

DODGE TRUCK

- 1977-91 Truck**
CA77D150A(C)P (Automatic) \$205.00/ea.
 ☞ Available for 2 wheel drive models only.

BACKWALL CARPET



- 1978-79 Lil Red Express** ⁰⁵³
Loop Carpet
SK78CDT002101 (Black) \$204.00/ea.
1978-79 Dodge Truck ⁰⁵³
Cut-Pile Carpet
SK78CDT0021801 (Black) \$204.00/ea.
SK78CDT00217039 (Red) \$204.00/ea.

KICK PANEL INSULATION

Die-cut from the correct yellow insulation to properly fit behind the kick panels and reduce road noise.



- 1963-64 Fury & Sport Fury**
KI63CF \$43.00/kit

FIREWALL INSULATION



Die-cut from black fiberboard with yellow insulation attached to properly fit the firewall. Clips included.

- 1963-64 Fury & Sport Fury** ⁰⁵¹
F163CFW/O (no air) \$54.00/kit
F162CR-HTR (heater delete section) \$32.00/kit
 ☞ F162CR-HTR is the heater delete area only. For the complete firewall pad, F163CRW/O must be ordered with it.
1965-68 C-Body (all models) ⁰⁵¹
F165CFMPW/A (with air) \$69.00/kit
1967-71 Dodge Truck ⁰⁵¹
F167CDTW/O (no air) \$79.00/kit
1972-80 Dodge Truck ⁰⁵¹
F172CDTW/O (no air) \$69.00/kit

OEM FIREWALL INSULATION

Firewalls are cut and punched with standard factory holes and are shipped ready-to-install with the appropriate "period" insulation attached.

- 1965-68 C-Body** ⁰⁵²
F165CFMPO (no air) \$184.00/pr.
F165CFMPO-W/A (with air) \$184.00/pr.

SOUND DEADENER

This rubber/tar material installs under the carpet to reduce heat and noise. Pre-cut to correct shape and size.

- 1963-71 C-Body (all models)** ⁰⁵¹
SD65CFMP \$99.00/ea.
1972/80 Dodge Truck ⁰⁵¹
SD72CDT \$95.00/ea.

CARPET YARDAGE

- Loop Carpet** ⁰⁵²
CAYD(C) (1 yard) \$79.00/yd.
 ☞ For colors other than black please refer to color code list
Loop "Tuxedo" Carpet ⁰⁵²
CAYD(C) (1 yard) \$129.00/yd.
 ☞ For colors other than black please refer to color code list
Cut-pile Carpet ⁰⁵²
CAYD(C)P (1 yard) \$79.00/yd.

JUTE BACKING

This insulating material when placed between the floorpan and molded carpet enhances sound barrier protection from road noise and adds cushion to your carpet. Also helpful for insulating headliners, trunk areas and more. 36"x36" cut.

- TA200ZFELT** (20 oz.) \$19.00/yd.
TA400ZFELT (40 oz.) \$29.00/yd.



LEGENDARY'S CUSTOM VINTAGE RUBBER STYLE FLOORMATS

DESIGNED TO FIT WHOLE FLOORPAN OF CAR LOGOS ON FRONT AND REAR MATS

How many times have you wished for automotive floor mats that have floorpan shapes, that are easily cleanable and also have that "factory original" styling that would make you proud to display them in your classic car? Our "Custom Vintage" rubber style floor mats will please the most discriminating buyer and provide years of carefree use.



www.legendaryautointeriors.com

CUSTOM DESIGN FLOORMATS

AVAILABLE IN ALL YEARS,
MAKES AND MODELS



Warlock II

1 Color
insert

Adds \$25 to base price



Warlock II

2 Color
insert

Adds \$50 to base price

DESIGN YOUR OWN
INSERTS & COLORS

www.legendaryautointeriors.com



FLOORMAT BASE & INSERT COLORS

BASE COLORS

001 Black - 002 White - 007 Dark Blue - 011 Medium Blue - 018 Bright Red - 020 Red - 023 Tan - 031 Maroon
 033 Dark Gold - 037 Aqua - 050 Turquoise - 051 Lime Green - 054 Purple - 057 Dk Olive Green
 074 Pink - 079 Gray - 098 Brown - 129 Dark Saddle - 132 Gold

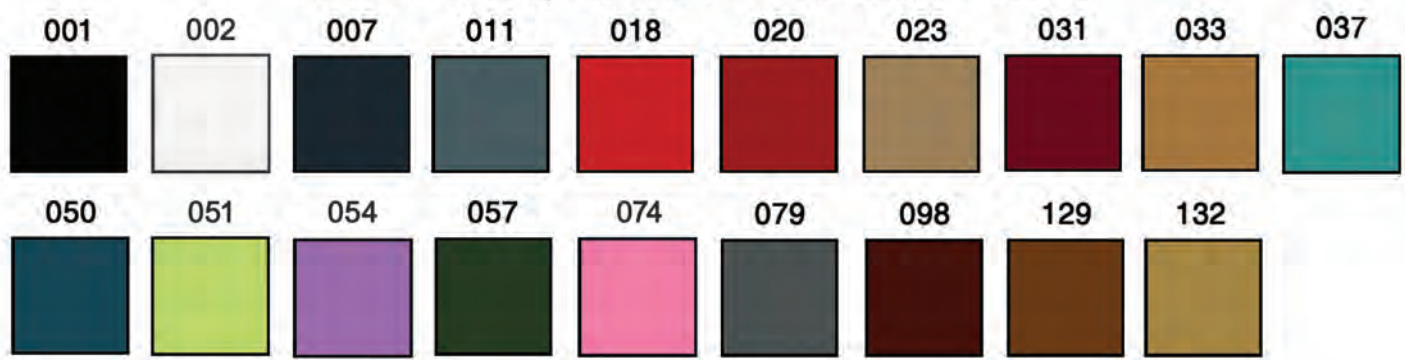

INSERT COLORS

133 Cream - 134 Sandalwood - 137 Aztec Gold - 138 Buckskin - 139 Sienna - 141 Coffee Bean - 142 Football
 143 Basketball - 150 Lemon Twist - 151 Mellow Yellow - 154 Plum Crazy - 156 Sky Blue - 157 Light Blue
 159 Pacific Blue - 160 Caribbean Blue - 161 Royal Blue - 163 Navy Blue - 165 Sassy Grass - 166 Pine
 167 Mint Green - 168 Hunter Green - 169 Antique Green - 170 Aqua Marine - 171 Mango - 173 Sunset Orange
 174 Panther Pink - 176 Cherry Red - 177 Cranberry - 178 Razzberry - 179 Garnet - 180 Smoke
 181 Platinum - 182 Medium Grey - 183 Silver - 184 Charcoal

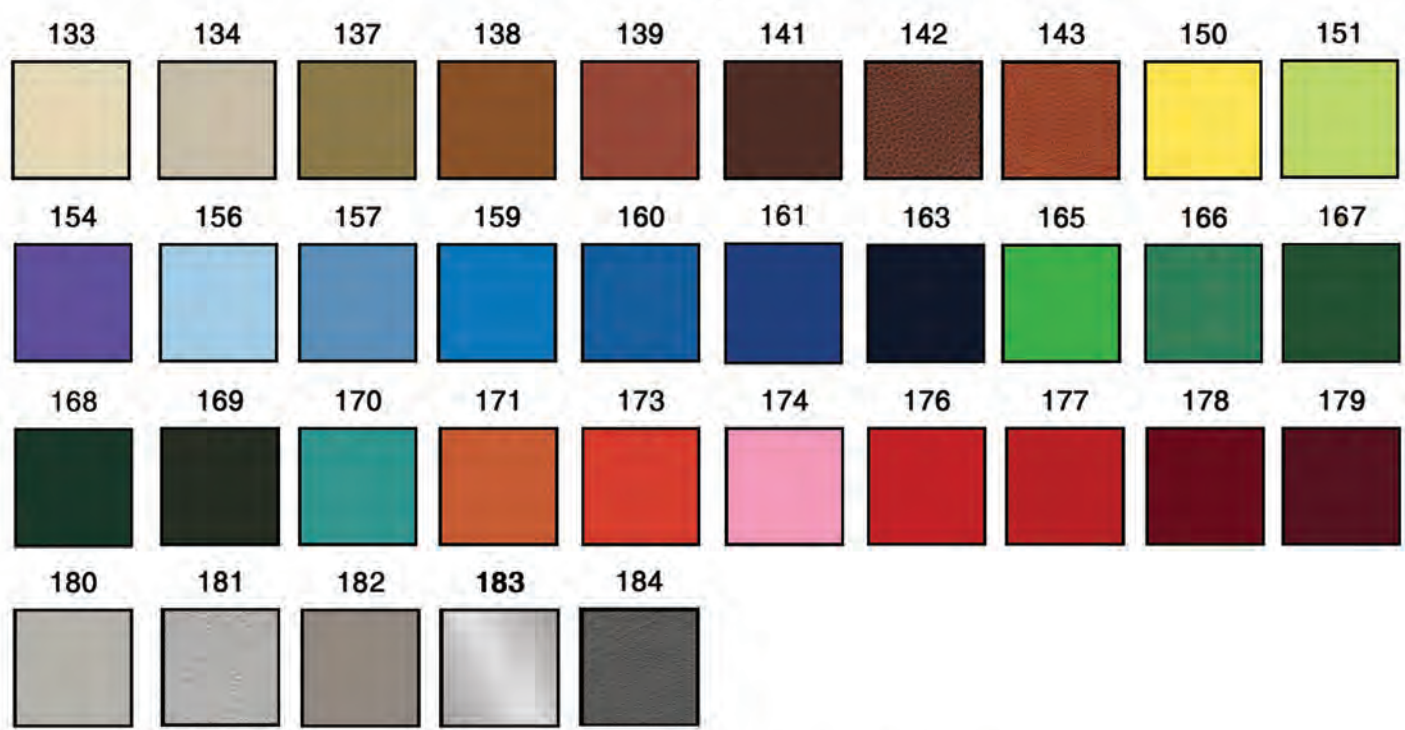

***Note - To order mats with colored inserts please call our sales department**

Actual colors will vary from samples on this page. Contact our Sample Request Department for actual color samples at 1-800-363-8804 or send us an email through our Sample Request Center on our website at www.legendaryautointeriors.com



1972-80 DODGE TRUCK '4WD'



**ALL NEW
DESIGN!!**

SURE-GRIP™
CONVEX ANTI-SKID BACKING



www.legendaryautointeriors.com

FLOORMAT PRICING:
ALL COLORS - \$209.00/set

1972-80 Dodge Truck
FMDT0062079(C)

1972-80 Adventurer
FMDT0062078(C)

1974-80 Ram Charger
FMDT0062076(C)

1976-78 Warlock
FMDT0062077(C)

1977-80 Power Wagon
FMDT0062080(C)

1979 Warlock II
FMDT0062081(C)

1972-80 Dodge Truck

Dodge

1972-80 Adventurer

Adventurer

1974-80 Ram Charger

RAMCHARGER

1976-78 Warlock

Warlock

1979 Warlock II

Warlock II

1977-80 Power Wagon

POWER WAGON

1972-80 DODGE TRUCK '2WD'

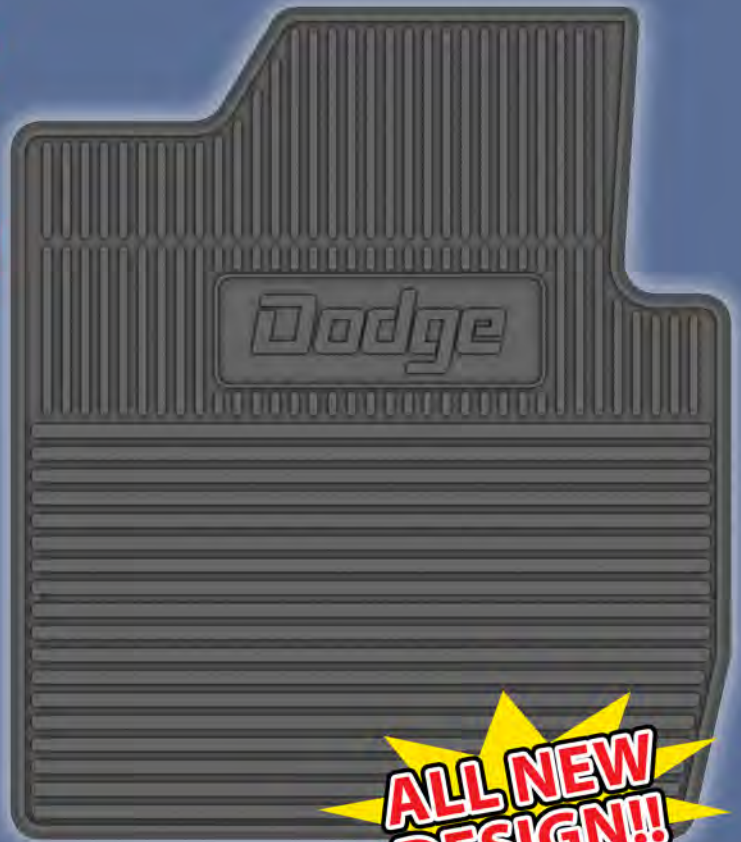

**ALL NEW
DESIGN!!**

SURE-GRIP™
CONVEX ANTI-SKID BACKING



www.legendariautointeriors.com

FLOORMAT PRICING:
ALL COLORS - \$209.00/set

1972-80 Dodge Truck
FMDT0060079(C)

1972-80 Adventurer
FMDT0060078(C)

1975-80 Ram Charger
FMDT0060076(C)

1976-78 Warlock
FMDT0060077(C)

1979 Warlock II
FMDT0060081(C)

1978 Midnite Express
FMDT0060074(C)

1978-79 Li'l Red Express
FMDT0060072(C)

1972-80 Dodge Truck



1972-80 Adventurer



1975-80 Ram Charger



1976-78 Warlock



1979 Warlock II

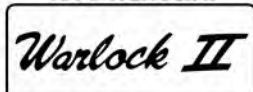

1978 Midnite Express



1978-79 Li'l Red Express



1981-93 DODGE TRUCK '4WD'



**ALL NEW
DESIGN!!**

SURE-GRIP™
CONTOUR ANTI-SKID BACKING



www.legendaryautointeriors.com

FLOORMAT PRICING:
ALL COLORS - \$209.00/set

1981-93 Dodge Truck
FMDT0063079(C)

1981-93 Ram Charger
FMDT0063073(C)

1981-93 Power Ram
FMDT0063075(C)

1981-93 Dodge Truck



1981-93 Ram Charger



1981-93 Power Ram



1981-93 DODGE TRUCK '2WD'

SURE-GRIP™
CHRYSLER ANTI-SKID BACKING



www.legendaryautointeriors.com

FLOORMAT PRICING:
ALL COLORS - \$209.00/set

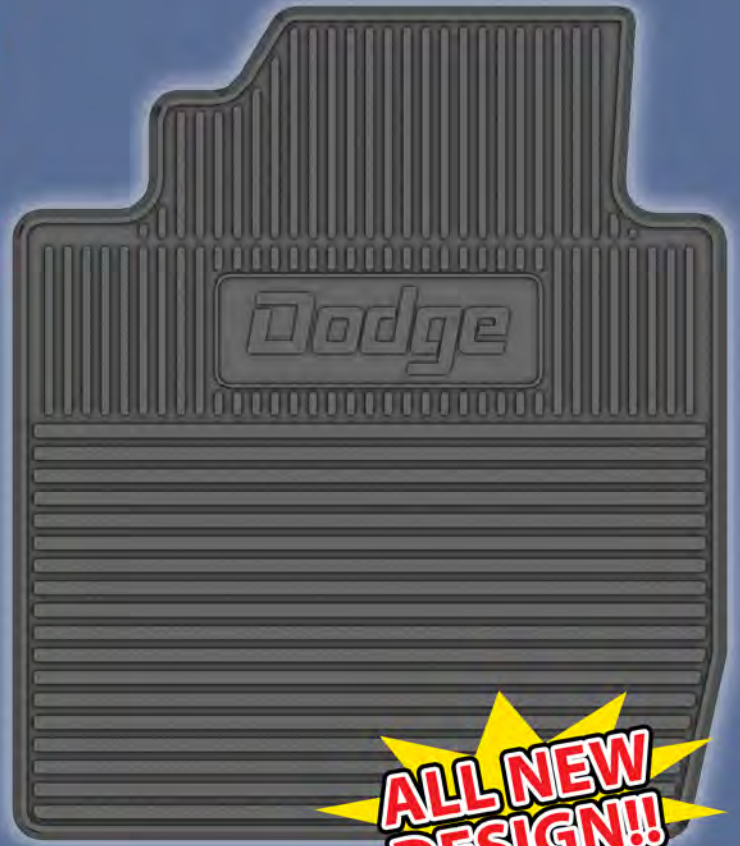

**ALL NEW
DESIGN!!**

1981-93 Dodge Truck
FMDT0061079(C)

1981-93 Ram Charger
FMDT0061073(C)

1981-93 Dodge Truck



1981-93 Ram Charger



NOW AVAILABLE...

2006-24 CHALLENGER & CHARGER!!



 OFFICIAL LICENSED PRODUCT

FLEXTREAD®

CHARGER

CHALLENGER

Challenger

SXT

GT

DAYTONA

R/T

R/T

T/A

SRT

SRT 

HELLCAT 

SRT 

SCAT PACK 

392
HEMI

 DEMON

HEMI

DODGE 

1-833-700-3539 WWW.FLEXTREADMATS.COM

FLEXTREAD®

**NOW AVAILABLE...
FLOOR MATS FOR
2009-24 RAM 1500/2500/3500**



RAM



BIGHORN

LONGHORN

LARAMIE



POWER WAGON

REBEL



WARLOCK





833-700-3539 WWW.FLEXTREADMATS.COM



DASHES, CONSOLES AND ACCESORIES

 facebook.com/legendaryautointeriors
 twitter.com/legendaryautoin

 www.legendaryautointeriors.com
 instagram.com/legendaryautointeriorsltd
 youtube.com/user/legendaryauto

CONSOLE CARPET KITS

Carpet kits for B & C-Body bucket seat interiors with center console option. Ready to install kits come with fully bound carpet attached to die-cut panel board as original where applicable by year.

B-BODY MODELS

1962-63 B-Body (all models)
CC62CFPR(C).....\$75.00/kit
 Please refer to carpet color selection page to specify carpet color at time of order.

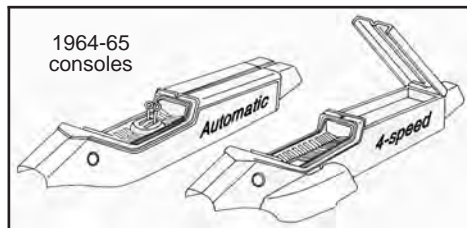
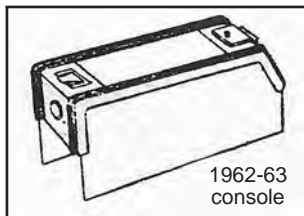

1964 B-Body automatic console carpet

1964 B-Body (all models)
CC64CFPRWA(C) (automatic).....\$153.00/kit
CC64CFPRWS(C) (manual).....\$153.00/kit
 Please refer to carpet color selection page to specify carpet color at time of order.

C-BODY MODELS

1963-64 Chrysler 300 & Newport
CC63CM(C) (automatic).....\$153.00/kit
 Please specify carpet color at time of order.

1965 Chrysler B-Body
CC65CFPRWA(C) (automatic).....\$153.00/kit
CC65CFPRWS(C) (manual).....\$153.00/kit
 Please specify carpet color at time of order.

1965 Chrysler C-Body
CC65CMA(C) (automatic).....\$153.00/kit
CC65CMS(C) (manual).....\$153.00/kit
 Please specify carpet color at time of order.

1966-70 Chrysler 300, Monaco & Polara Newport & Sport Fury
CC66CRWA(C) (automatic).....\$75.00/kit
CC66CRWXS(C) (manual).....\$75.00/kit
 Please specify carpet color at time of order.

4-SPEED CONSOLE SIDE COVER



Reproduction console side cover for 1966-70 B & C-Body models (except '66 Charger) with manual transmission. Molded in black plastic (originals were fiberboard) to original specifications.

CS66CFMPRWX4SP\$110.00/ea.

DASH VENTS

Exact duplicates of the original dash vents found on the top portion of the dash. Available in black only but can be painted to match interior colors. Fastening nuts included.



1962-64 B-Body (all models)
DP62C-VENT\$89.00/pr.

1972-80 Dodge Truck
DP62C-VENT\$89.00/pr.

DASH VENT HOSE KITS

Dash vents and fastening nuts (same as above) with new reproduction vent hoses. Kits include 2 vents with fastening nuts and 2 hoses with clips.



1962-64 B-Body (all models)
DP62C-VHKIT\$139.00/pr.

1972-80 Dodge Truck
DP62C-VHKIT\$139.00/pr.

SHIFTER BOOTS & BEZELS



Clutch release fork boot for 1964-74 B & C-Body 4-Speed & 3-Speed column shift

1964-74 A,B,C & E-Body
TN64ABCE-BOOT\$39.00/ea.

UNDERDASH INSULATION

Die-cut to original specifications, this insulation eliminates underdash noise and vibration.

1965-68 C-Body (all models)
UD65CFMP\$32.00/kit



GLOVEBOX LINERS

Glovebox liners are die-cut and pre-stapled with mounting hardware attached for easy installation. Fuse box doors included where applicable.



B-BODY MODELS

- 1962 Polara, Fury & Sport Fury**
GB62CFP\$32.00/ea.
- 1963 Polara, Belvedere, Fury & Sport Fury**
GB63CFPR\$43.00/ea.
- 1964 Polara, Belvedere, Fury & Sport Fury**
GB64CFRP (no air)\$32.00/ea.
GB64CFRPA (with air)\$32.00/ea.

C-BODY MODELS

- 1960-62 Chrysler 300 & Newport**
GB60CM (no air)\$54.00/ea.
GB60CMA (with air)\$54.00/ea.
- 1963-64 Chrysler 300 & Newport**
GB63CM (no air)\$54.00/ea.
GB63CMA (with air)\$54.00/ea.
- 1965-66 Fury & Sport Fury**
GB65CF\$32.00/ea.
- 1965-66 Polara & Monaco**
GB65CP (no air)\$32.00/ea.
GB65CPA (with air)\$43.00/ea.
- 1967-68 Chrysler 300 & Newport**
GB67CM\$54.00/ea.
- 1967-68 Fury & Sport Fury**
GB67CF\$43.00/ea.
- 1967-68 Polara & Monaco**
GB67CP\$43.00/ea.
- 1969-70 Chrysler 300**
GB69CM\$54.00/ea.
- 1969-72 Fury & Sport Fury**
GB69CF (no air)\$43.00/ea.
GB69CFA (with air)\$43.00/ea.

DODGE TRUCK & VAN

- 1961-66 Dodge Truck**
GB61CDT\$32.00/ea.
- 1967-71 Dodge Truck**
GB67CDT\$32.00/ea.
- 1964-70 A-100 Van**
GB64CDV\$32.00/ea.

PEDAL PADS & BEZELS

Reproduction pedal pads and bezels for accelerators, brake/clutch and parking brake on B-Body models.

ACCELERATORS & BEZELS



- 1962-64 B-Body**
PB63AB-A (pad w/ raised dots)\$59.00/ea.

AUTOMATIC BRAKE PADS & BEZELS

- 1962-64 B-Body**
PB63ABA-B (pad w/ raised dots)\$39.00/ea.

4-SPEED CLUTCH /BRAKE PADS & BEZELS



- 1962-64 B-Body**
PB63AB4SP-B/C (pad w/ dots)\$19.00/ea.

PARKING BRAKE PADS



- 1962-64 B-Body**
PB63AB-P (pad w/ dots) (shown)\$19.00/ea.



Providing the automotive industry
with the world's highest quality
soft trim products and services
RIGHT HERE AT HOME

STILL ASSEMBLED AND
MADE IN THE ★★★★★
USA 

THERE REALLY IS A DIFFERENCE!!



Legendary
AUTO INTERIORS LTD.



www.legendaryautointeriors.com





HEADLINERS AND TRIM ACCESORIES

 facebook.com/legendaryautointeriors
 twitter.com/legendaryautoin

 www.legendaryautointeriors.com
 instagram.com/legendaryautointeriorsltd
 youtube.com/user/legendaryauto

Headliner Grains and Colors

Legendary Auto Interiors headliners are manufactured to original specifications and are available in a variety of colors in Perforated or Non-Perforated pattern. Each headliner is assembled with heavy-duty stitching.

If your year/model is not listed please contact our sales department for assistance on availability. Please specify perforated or non-perforated at time of order. Sample approval is highly recommended for colors other than black.

STANDARD style

Non-Perforated

01 Black	02 White	03 Red	07 Dark Blue
11 Medium Blue	13 Dark Green	17 Buckskin	18 Light Blue
20 Bright Red	31 Maroon	38 Sandalwood	98 Brown

Perforated

01 Black	02 White	03 Red	07 Dark Blue
11 Medium Blue	13 Dark Green	17 Buckskin	18 Light Blue
20 Bright Red	31 Maroon	38 Sandalwood	98 Brown

OEM style

Legendary Auto Interiors, Ltd. is pleased to announce another first in the industry. "As Original" headliners and sail panels are now available for 1965-66 and 1969-72 Dodge, Plymouth and Chrysler cars. All new headliner styles have a heavier cotton/poly cloth backing with more vibrant colors and finishes like the ORIGINAL!! This will assure longevity to these new products as the vinyl and backing are much higher quality than other vinyls offered in today's automotive marketplace.

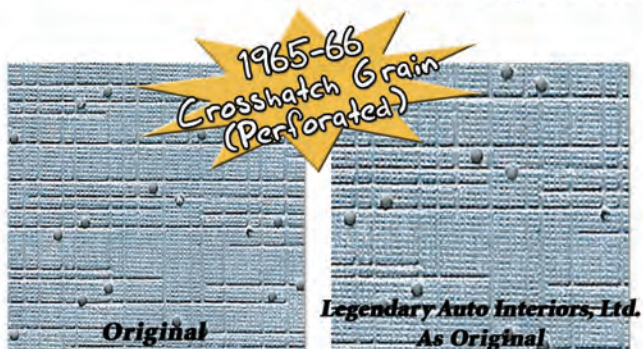

101 Black	102 White
111 Light Met. Blue	121 Metallic Red

101 Black	102 White	107 Dark Blue
110 Bright Blue	113 Dark Green	122 Burnt Orange

HEADLINERS AND ACCESSORIES

B-BODY MODELS

1963 Polara 500
Hardtop - (Perforated Grain)
 HL63CP01 (Black)..... \$169.00/ea.
 HL63CP02 (White)..... \$169.00/ea.

1963 Fury & Sport Fury
Hardtop - (Perforated Grain)
 HL63CF01 (Black)..... \$169.00/ea.
 HL63CF02 (White)..... \$169.00/ea.
 ☞ For 1963 Sport Fury with black & red interiors, the headliners were always white. Any other color is considered custom. No custom charge will be applied.

1964 Polara & Polara 500
1964 Fury & Sport Fury
Hardtop - (Perforated Grain)
 HL64CFPR01 (Black)..... \$169.00/ea.
 HL64CFPR02 (White)..... \$169.00/ea.

1964 Fury
2 & 4 Door Sedan (Perforated Grain)
 HL64CFPRW01 (Black)..... \$169.00/ea.
 HL64CFPRW02 (White)..... \$169.00/ea.

C-BODY MODELS

1963 Chrysler 300
2 Door Hardtop - (Perforated Grain)
 HL63CM02P (White)..... \$174.00/ea.

1964 Chrysler 300
2 Door Hardtop - (Perforated Grain)
 HL64C300K02 (White)..... \$279.00/ea.

1965 Chrysler 300 & Newport
2 Door Hardtop - (Perforated Grain)
 HL65CM01 (Black)..... \$198.00/ea.
 HL65CM02 (White)..... \$198.00/ea.

1965 Chrysler 300 & Newport
2 Door Hardtop - OEM Style
(Crosshatch Grain)
 HL65CM101 (Black)..... \$270.00/ea.
 HL65CM102 (White)..... \$270.00/ea.
 HL65CM111 (Light Metallic Blue)..... \$270.00/ea.
 HL65CM121 (Metallic Red)..... \$270.00/ea.

1966 Chrysler 300
2 Door Hardtop - (Perforated Grain)
 HL66CM01 (Black)..... \$198.00/ea.
 HL66CM02 (White)..... \$198.00/ea.
 HL66CM07 (Dark Blue)..... \$198.00/ea.
2 Door Hardtop - OEM Style
(Crosshatch Grain)
 HL66CM101 (Black)..... \$270.00/ea.
 HL66CM102 (White)..... \$270.00/ea.
 HL66CM121 (Metallic Red)..... \$270.00/ea.

1967 Chrysler 300, Newport & New Yorker
2 Door Hardtop - (Perforated Grain)
 HL67CM01 (Black)..... \$198.00/ea.
 HL67CM02 (White)..... \$198.00/ea.
 HL67CM11 (Medium Blue)..... \$198.00/ea.

1968 Chrysler 300, Newport & New Yorker
2 Door Hardtop - (Perforated Grain)
 HL68CM01 (Black)..... \$198.00/ea.
 HL68CM02 (White)..... \$198.00/ea.
 HL68CM31 (Maroon)..... \$198.00/ea.

C-BODY MODELS CONT.

1965 Polara, 880 Custom & Monaco
1965 Fury III & Sport Fury
4 Bow Hardtop - (Perforated Grain)
 HL65CFP401 (Black)..... \$198.00/ea.
 HL65CFP402 (White)..... \$198.00/ea.
4 Bow Hardtop - OEM Style
(Crosshatch Grain)
 HL65CFP4101 (Black)..... \$255.00/ea.
 HL65CFP4102 (White)..... \$255.00/ea.
 HL65CFP4111 (Light Metallic Blue) ... \$255.00/ea.
 HL65CFP4121 (Metallic Red)..... \$255.00/ea.

1966 Polara & Monaco
1966 Fury III & Sport Fury
4 Bow Hardtop - (Perforated Grain)
 HL66CFP401 (Black)..... \$198.00/ea.
 HL66CFP402 (White)..... \$198.00/ea.

1966 Polara & Monaco
1966 Fury III & Sport Fury
4 Bow Hardtop - OEM Style
(Crosshatch Grain)
 HL66CFP4101 (Black)..... \$270.00/ea.
 HL66CFP4111 (Light Metallic Blue) ... \$270.00/ea.
 HL66CFP4121 (Metallic Red)..... \$270.00/ea.
5 Bow Hardtop - (Perforated Grain)4
 HL66CFP501 (Black)..... \$198.00/ea.
 HL66CFP502 (White)..... \$198.00/ea.

1966 Polara & Monaco
1966 Fury III & Sport Fury
5 Bow Hardtop - OEM Style
(Crosshatch Grain)
 HL66CFP5111 (Light Metallic Blue) ... \$270.00/ea.
 ☞ Please specify 4 or 5 bows at time of order.

1967 Fury III & Sport Fury
Hardtop - (Perforated Grain)
 HL67CFH01 (Black)..... \$198.00/ea.
Hardtop - OEM Style - (Fine Pembroke Grain)
 HL67CFH101 (Black)..... \$270.00/ea.
 HL67CFH102 (White)..... \$270.00/ea.
 HL67CFH107 (Dark Blue)..... \$270.00/ea.
Fastop - OEM Style - (Fine Pembroke Grain)
 HL67CFF101 (Black)..... \$270.00/ea.
 HL67CFF102 (White)..... \$270.00/ea.
 HL67CFF107 (Dark Blue)..... \$270.00/ea.
 HL67CFF113 (Dark Green)..... \$270.00/ea.

1968 Polara & Monaco
Hardtop - (Perforated Grain)
 HL68CF01 (Black)..... \$198.00/ea.
 HL68CP11 (Medium Blue)..... \$198.00/ea.
Hardtop - OEM Style - (Fine Pembroke Grain)
 HL68CF101 (Black)..... \$270.00/ea.
 HL68CP102 (White)..... \$270.00/ea.

1968 Fury III & Sport Fury
Hardtop - (Perforated Grain)
 HL68CF3H01 (Black)..... \$198.00/ea.
 HL68CF3H02 (White)..... \$198.00/ea.
 HL68CF3H13 (Dark Green)..... \$198.00/ea.
Hardtop - OEM Style - (Fine Pembroke Grain)
 HL68CF3H101 (Black)..... \$270.00/ea.
 HL68CF3H102 (White)..... \$270.00/ea.
 HL68CF3H113 (Dark Green)..... \$270.00/ea.
Fastop - (Perforated Grain)
 HL68CF01F (Black)..... \$198.00/ea.
 HL68CF02F (White)..... \$198.00/ea.
 HL68CF13F (Dark Green)..... \$198.00/ea.
Fastop - OEM Style - (Fine Pembroke Grain)
 HL68CF101F (Black)..... \$270.00/ea.
 HL68CF102F (White)..... \$270.00/ea.
 HL68CF113F (Dark Green)..... \$270.00/ea.

HEADLINER RETAINING CLIPS



Metal u-shaped retaining clips slide onto the edge of the roof-rail and help hold the headliner in place.

HLCLIP (Pkg/12).....\$5.00/pk.

HEADLINER BOW RETAINER CLIPS



Metal retainer clips slide onto the edge of the roof-rail and help secure headliner bows during installation of headliner.

HLRETAIN (Pkg/10).....\$39.00/pk.

HEADLINER INSULATION

Headliner insulation kits glue directly to the roof and provide protection from noise, heat and cold infiltration.

1963-64 B-Body
 HI63CFPRW.....\$32.00/kit

1969-72 C-Body
 HI69CFMP.....\$54.00/kit

NOS HEADLINERS

Some colors and grains are not reproduced in today's market. We offer NOS (New Old Stock) headliners for those extremely limited items. Many years and models are available. Please call for assistance.

HLNOS..... \$935.00/ea.

☞ Please specify year and model.

DOME LIGHT LENS



Round plastic dome light lens for 1966-74 B & C-Body models.

LL66ABCE-DOME.....\$10.00/ea.

SAIL PANEL BOARDS



Die-cut to original size and shape, these reproduction sail panel boards replace warped or water damaged originals. Available covered with headliner material or plain where applicable by year and model.

NOTE: Due to a special proprietary process used in-house, we guarantee the vinyl WILL NOT bubble or delaminate from the board.

C-BODY MODELS

1965 Polara/Polara 500 & Monaco

OEM Style - (Crosshatch Grain)

SB65CP101 (Black) \$97.00/pr.

SB65CP111 (Light Metallic Blue) \$97.00/pr.

SB65CP121 (Metallic Red) \$97.00/pr.

COURTESY LIGHT LENSES

Round plastic courtesy light lenses located on the sail panels for 1964-66 B & C-Body models.

LL65BC-CRTSY \$29.00/pr.

REAR WINDOW TRIM



Reproduction molded plastic trim replaces frequently cracked or broken original trim. Available in black only or can be painted to match other interior colors.

1964 B-Body

(2 & 4-door Hardtop & Sedan)

RT64C-B03 (3 pc.) \$ 79.00/kit





SUNVISORS

Original reproduction sunvisors are made with the correct grains and vinyl colors as applicable by year/make/model to compliment and match your Legendary interior. Superior materials and technology with World Class craftsmanship create the highest quality sunvisors available. Original mounting hardware and metal rod must be reused. Please specify hardtop or convertible and color at time of order.

- Factory correct size, shape, colors and grains by year, make and model
- Original fit and appearance
- Custom colors and grains available
- Limited Lifetime Warranty (*First and only in the industry!!!*)
- Correct multi layer construction applicable by year, make and model
- Available with or without cut-outs for driver and passenger mirror options



Correct multi layer construction & shape applicable by year, make, model & body style

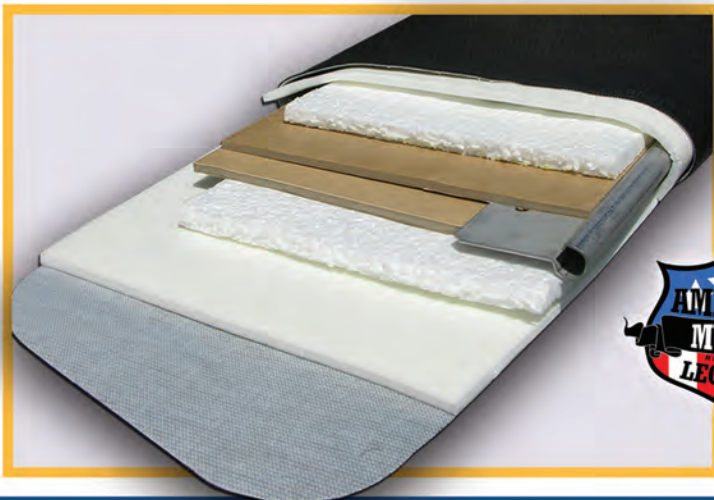

SUNVISORS

B-BODY MODELS

1963-64 Polara, Polara 500, Fury & Sport Fury Hardtop (Weymouth Perforated Grain)

- SV63CFPRW01-PA (Black).....\$168.00/pr.
- SV63CFPRW02-PA (White).....\$168.00/pr.
- SV63CFPRW11-PA (Medium Blue).....\$168.00/pr.
- SV63CFPRW20-PA (Bright Red).....\$168.00/pr.
- SV63CFPRW38-PA (Sandalwood).....\$168.00/pr.

Convertible (Bison Grain)

- SV63CFPRW100C-PA (Black).....\$168.00/pr.
- SV63CFPRW206C-PA (Taupe).....\$176.00/pr. (L4)
- SV63CFPRW302C-PA (Blue).....\$176.00/pr. (L4)
- SV63CFPRW314C-PA (Met Blue).....\$168.00/pr.
- SV63CFPRW406C-PA (Lt Turquoise).....\$176.00/pr. (L4)
- SV63CFPRW410C-PA (Lt Met Olive).....\$168.00/pr.
- SV63CFPRW416C-PA (Met Turq.).....\$168.00/pr.
- SV63CFPRW510C-PA (Crimson Red).....\$168.00/pr.
- SV63CFPRW606C-PA (DK Copper).....\$176.00/pr. (L4)
- SV63CFPRW610C-PA (Met Fawn).....\$176.00/pr. (L4)

C-BODY MODELS

1963-64 Chrysler 300

Convertible - (Bison Grain)

- SV63CM100C-PA (Black).....\$182.00/pr.
- SV63CM202C-PA (Pearl White).....\$182.00/pr.
- SV63CM204C-PA (Dark White).....\$191.00/pr. (L4)
- SV63CM206C-PA (Taupe).....\$191.00/pr. (L4)
- SV63CM314C-PA (Metallic Blue).....\$182.00/pr.
- SV63CM339C-PA (Metallic Blue).....\$182.00/pr.
- SV63CM406C-PA (Turquoise).....\$191.00/pr. (L4)
- SV63CM520C-PA (Metallic Red).....\$182.00/pr.
- SV63CM530C-PA (Claret Red).....\$182.00/pr.
- SV63CM610C-PA (Metallic Fawn).....\$191.00/pr. (L4)

1963-64 Chrysler 300

Hardtop - (Non-Perforated Grain)

- SV63CM02-PA (White).....\$182.00/pr.

1965-66 Chrysler 300, Newport, Polara, Monaco, Fury & Sport Fury

Hardtop OEM Style (Crosshatch Grain)

- SV65CFMP101-PA (Black).....\$245.00/pr.
- SV65CFMP102-PA (White).....\$245.00/pr.
- SV65CFMP111-PA (Lt Met Blue).....\$245.00/pr.
- SV65CFMP121-PA (Metallic Red).....\$245.00/pr.

1965-66 Chrysler 300 & Newport

Convertible (Cologne Grain)

- SV65CM100C-PA (Black).....\$182.00/pr.
- SV65CM102C-PA (Silver).....\$182.00/pr.
- SV65CM202C-PA (Pearl White).....\$182.00/pr.
- SV65CM320C-PA (Met Navy).....\$182.00/pr.
- SV65CM322C-PA (Med Met Blue).....\$182.00/pr.
- SV65CM520C-PA (Metallic Red).....\$182.00/pr.
- SV65CM610C-PA (Metallic Fawn).....\$191.00/pr. (L4)
- SV65CM614C-PA (Gold).....\$182.00/pr.
- SV65CM614C-PA (Ginger).....\$182.00/pr.

1966-68 Chrysler 300, Newport, New Yorker, Polara, Monaco, Fury & Sport Fury

Hardtop (Cologne Grain)

- SV66CFMP100-PA (Black).....\$182.00/pr.
- SV66CFMP202-PA (Pearl White).....\$182.00/pr.
- SV66CFMP318-PA (Lt Metallic Blue).....\$182.00/pr.
- SV66CFMP320-PA (Metallic Navy).....\$182.00/pr.
- SV66CFMP330-PA (Dark Met. Blue).....\$182.00/pr.
- SV66CFMP332-PA (Lt Metallic Blue).....\$182.00/pr.
- SV66CFMP420-PA (Citron).....\$191.00/pr. (L4)
- SV66CFMP430-PA (Dark Green).....\$182.00/pr.
- SV66CFMP520-PA (Metallic Red).....\$182.00/pr.
- SV66CFMP614-PA (Gold).....\$182.00/pr.
- SV66CFMP616-PA (Ginger).....\$182.00/pr.
- SV66CFMP620-PA (Copper).....\$182.00/pr.

C-BODY MODELS CONT.

1969-70 Chrysler 300, Newport, New Yorker, Polara, Monaco, Fury & Sport Fury Convertible (Coachman Grain)

- SV69CFMP100C-PA (Black).....\$182.00/pr.
- SV69CFMP200C-PA (White).....\$182.00/pr.
- SV69CFMP330C-PA (Dark Blue).....\$182.00/pr.
- SV69CFMP332C-PA (Light Blue).....\$182.00/pr.
- SV69CFMP336C-PA (Navy).....\$182.00/pr.
- SV69CFMP434C-PA (Dark Green).....\$182.00/pr.
- SV69CFMP528C-PA (Red).....\$182.00/pr.
- SV69CFMP650C-PA (Saddle).....\$182.00/pr.
- SV69CFMP656C-PA (Brown).....\$182.00/pr.

1970-71 Chrysler 300, Newport, New Yorker, Polara, Monaco, Fury & Sport Fury Hardtop (Coachman Grain)

- SV70CFMP100-PA (Black).....\$182.00/pr.
- SV70CFMP200-PA (White).....\$182.00/pr.
- SV70CFMP332-PA (Lt Met Blue).....\$182.00/pr.
- SV70CFMP434-PA (Dk Met Green).....\$182.00/pr.
- SV70CFMP452-PA (Dk Met Green).....\$182.00/pr.
- SV70CFMP540-PA (Burnt Orange).....\$182.00/pr.
- SV70CFMP656-PA (Brown).....\$182.00/pr.
- SV70CFMP660-PA (Gold).....\$191.00/pr. (L4)
- SV70CFMP664-PA (Brown).....\$191.00/pr. (L4)
- SV70CFMP699-PA (Beige).....\$182.00/pr.

DODGE TRUCK

1978 Lil Red Express & Warlock (Oxford Grain)

- SV78CDT0000100 (Black).....\$168.00/pr.
- SV78CDT0000548 (Red).....\$168.00/pr.

1979 Lil Red Express & Warlock (Oxford Grain)

- SV79CDT0000100 (Black).....\$168.00/pr.
- SV79CDT0000548 (Red).....\$168.00/pr.

PLASTIC SUNVISOR TIPS



Reproduction 1962-65 Dodge & Plymouth sunvisor tips made of Delrin plastic.

- SV62TIP.....\$29.00/pr.

RUBBER SUNVISOR TIPS



Dodge & Plymouth rubber sunvisor tips for 1966 and up models with 2-pin sunvisors and a center mounted sunvisor retainer over the rearview mirror.

- SVTIP-RUBBER.....\$3.00/pr.





Providing the automotive industry
with the world's highest quality
soft trim products and services
RIGHT HERE AT HOME

STILL ASSEMBLED AND
MADE IN THE ★★★★★
USA 

THERE REALLY IS A DIFFERENCE!!

Legendary
AUTO INTERIORS LTD.

www.legendaryautointeriors.com



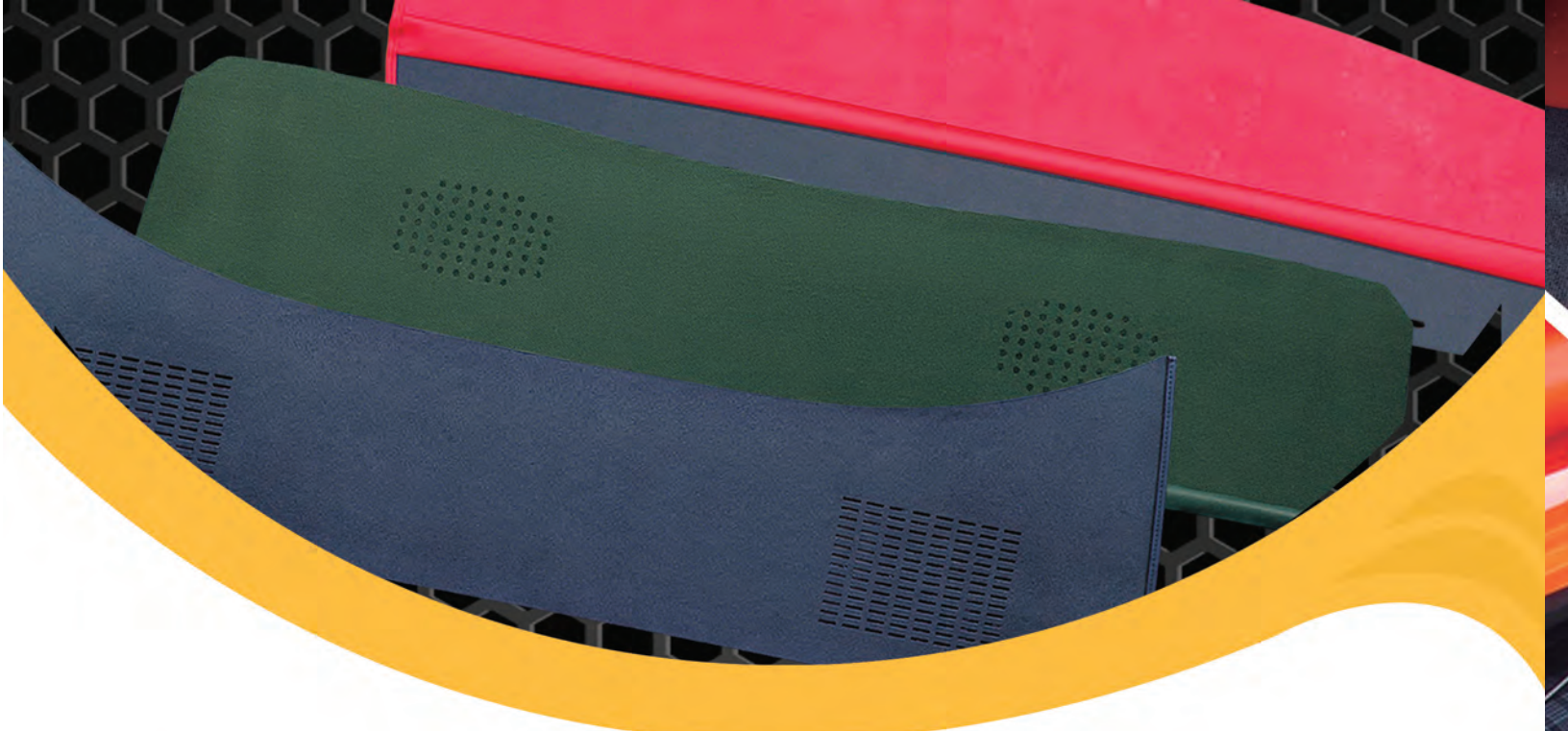





PACKAGE TRAYS AND JUTE INSULATION

Die-cut to original specifications, these reproductions of the original panels go between the top of the rear seat and the back window. Colors are year specific and are available with or without speaker grill cutouts. Die-cut jute insulation helps reduce the amount of noise and heat that would come from the trunk compartment.



PACKAGE TRAY AND TRUNK ACCESORIES

 facebook.com/legendaryautointeriors
 twitter.com/legendaryautoin

 www.legendaryautointeriors.com
 instagram.com/legendaryautointeriorsltd
 youtube.com/user/legendaryauto

PACKAGE TRAYS & JUTE INSULATION

B-BODY MODELS

**1963 Polara & Polara 500
1963 Fury & Sport Fury** 

- Hardtop w/o Cuts**
- PT63CF100N (Black) \$79.00/ea.
 - PT63CF206N (Taupe) \$79.00/ea.
 - PT63CF302N (Blue) \$79.00/ea.
 - PT63CF406N (Light Turquoise) \$79.00/ea.
 - PT63CF510N (Crimson Red) \$79.00/ea.
- Hardtop w/ Cuts**
- PT63CF100 (Black) \$119.00/ea.
 - PT63CF206 (Taupe) \$119.00/ea.
 - PT63CF302 (Blue) \$119.00/ea.
 - PT63CF406 (Light Turquoise) \$119.00/ea.
 - PT63CF510 (Crimson Red) \$119.00/ea.
 - PT63CFJ (jute insulation) \$27.00/ea.

1964 Polara, Fury 

- 4 Door w/o Cuts**
- PT64CFPRW314N (Metallic Blue) \$79.00/ea.
 - PT64CFPRW510N (Crimson Red) \$79.00/ea.
 - PT64CFPRW610N (Metallic Fawn) \$79.00/ea.
 - PT64CFPRWJ (jute insulation) \$27.00/ea.
- ☞ Fits 4-door hardtop & 4-door sedan models.

**1964 Polara & Polara 500
1964 Fury & Sport Fury**

- Hardtop w/o Cuts**
- PT64CRW100N (Black) \$79.00/ea.
 - PT64CRW314N (Metallic Blue) \$79.00/ea.
 - PT64CRW410N (Light Met. Olive) \$79.00/ea.
 - PT64CRW416N (Met. Turquoise) \$79.00/ea.
 - PT64CRW510N (Crimson Red) \$79.00/ea.
 - PT64CRW520N (Metallic Red) \$79.00/ea.
 - PT64CRW606N (Dark Copper) \$79.00/ea.
 - PT64CRW610N (Metallic Fawn) \$79.00/ea.
 - PT64CRW614N (Gold) \$79.00/ea.
- Hardtop w/ Cuts**
- PT64CRW100 (Black) \$119.00/ea.
 - PT64CRW314 (Metallic Blue) \$119.00/ea.
 - PT64CRW410 (Light Met. Olive) \$119.00/ea.
 - PT64CRW416 (Met. Turquoise) \$119.00/ea.
 - PT64CRW510 (Crimson Red) \$119.00/ea.
 - PT64CRW520 (Metallic Red) \$119.00/ea.
 - PT64CRW606 (Dark Copper) \$119.00/ea.
 - PT64CRW610 (Metallic Fawn) \$119.00/ea.
 - PT64CRW614 (Gold) \$119.00/ea.
- Hardtop w/ Center Cut**
- PT64CRW100C (Black) \$119.00/ea.
 - PT64CRW314C (Metallic Blue) \$119.00/ea.
 - PT64CRW410C (Light Met. Olive) \$119.00/ea.
 - PT64CRW416C (Met. Turquoise) \$119.00/ea.
 - PT64CRW510C (Crimson Red) \$119.00/ea.
 - PT64CRW520C (Metallic Red) \$119.00/ea.
 - PT64CRW606C (Dark Copper) \$119.00/ea.
 - PT64CRW610C (Metallic Fawn) \$119.00/ea.
 - PT64CRW614C (Gold) \$119.00/ea.
 - PT64CRWJ (jute insulation) \$27.00/ea.

B-BODY MODELS CONT.

**1964 Polara & Polara 500
1964 Fury & Sport Fury** 

- Hardtop w/o Cuts**
- PT64CRW100N (Black) \$79.00/ea.
 - PT64CRW314N (Metallic Blue) \$79.00/ea.
 - PT64CRW410N (Light Met. Olive) \$79.00/ea.
 - PT64CRW416N (Met. Turquoise) \$79.00/ea.
 - PT64CRW510N (Crimson Red) \$79.00/ea.
 - PT64CRW520N (Metallic Red) \$79.00/ea.
 - PT64CRW606N (Dark Copper) \$79.00/ea.
 - PT64CRW610N (Metallic Fawn) \$79.00/ea.
 - PT64CRW614N (Gold) \$79.00/ea.
- Hardtop w/ Cuts**
- PT64CRW100 (Black) \$119.00/ea.
 - PT64CRW314 (Metallic Blue) \$119.00/ea.
 - PT64CRW410 (Light Met. Olive) \$119.00/ea.
 - PT64CRW416 (Met. Turquoise) \$119.00/ea.
 - PT64CRW510 (Crimson Red) \$119.00/ea.
 - PT64CRW520 (Metallic Red) \$119.00/ea.
 - PT64CRW606 (Dark Copper) \$119.00/ea.
 - PT64CRW610 (Metallic Fawn) \$119.00/ea.
 - PT64CRW614 (Gold) \$119.00/ea.
- Hardtop w/ Center Cut**
- PT64CRW100C (Black) \$119.00/ea.
 - PT64CRW314C (Metallic Blue) \$119.00/ea.
 - PT64CRW410C (Light Met. Olive) \$119.00/ea.
 - PT64CRW416C (Met. Turquoise) \$119.00/ea.
 - PT64CRW510C (Crimson Red) \$119.00/ea.
 - PT64CRW520C (Metallic Red) \$119.00/ea.
 - PT64CRW606C (Dark Copper) \$119.00/ea.
 - PT64CRW610C (Metallic Fawn) \$119.00/ea.
 - PT64CRW614C (Gold) \$119.00/ea.
 - PT64CRWJ (jute insulation) \$27.00/ea.

C-BODY MODELS

☞ On All C-Body Models, please specify color package tray at time of order.

1965-66 Polara & Fury 

- Hardtop w/ Cuts**
- PT65CFP(C)N (Hardtop w/o cuts) \$79.00/ea.
 - PT65CFP(C)W (Hardtop w/ cuts) \$119.00/ea.
 - PT65CFPJ (jute insulation) \$27.00/ea.





TRUNK MATS

Original style rubber trunk mats die-cut to factory specifications to assure a correct fit. Please specify material pattern at time of order.

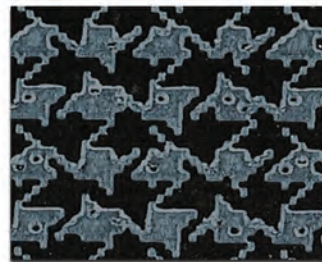

Houndstooth

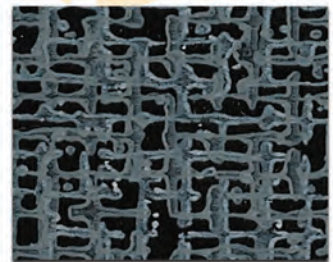

Herringbone

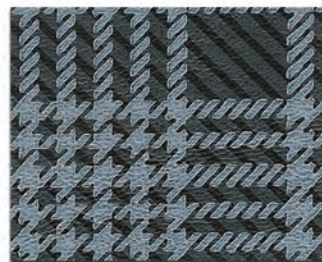

Gray Plaid

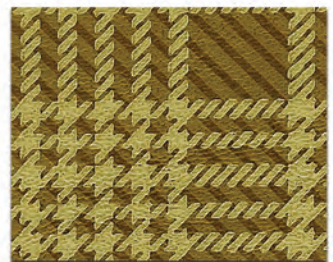

Tan Plaid

B-BODY MODELS

1962 Fury & Sport Fury

TM62CFGP (Hardtop)	\$99.00/ea.
TM62CFHT (Hardtop)	\$99.00/ea.
TM62CFTP (Hardtop)	\$99.00/ea.

1962 Polara & Polara 500 1962-64 Dodge 440

TM62CWGP (Hardtop)	\$99.00/ea.
TM62CWHT (Hardtop)	\$99.00/ea.
TM62CWTP (Hardtop)	\$99.00/ea.

1963 Polara & Polara 500

TM63CPGP (Hardtop)	\$99.00/ea.
TM63CPHT (Hardtop)	\$99.00/ea.
TM63CPTP (Hardtop)	\$99.00/ea.
TM63CPGPC (Convertible)	\$99.00/ea.
TM63CPHTC (Convertible)	\$99.00/ea.
TM63CPTPC (Convertible)	\$99.00/ea.

1963 Fury & Sport Fury

TM63CFRGP (Hardtop)	\$99.00/ea.
TM63CFRHT (Hardtop)	\$99.00/ea.
TM63CFRTP (Hardtop)	\$99.00/ea.
TM63CFGPC (Convertible)	\$99.00/ea.
TM63CFHTC (Convertible)	\$99.00/ea.
TM63CFTPC (Convertible)	\$99.00/ea.

☞ Convertible trunk mat not for Belvedere models.

1964 Polara & Polara 500

TM64CPGP (Hardtop)	\$99.00/ea.
TM64CPHT (Hardtop)	\$99.00/ea.
TM64CPTP (Hardtop)	\$99.00/ea.
TM64CPGPC (Convertible)	\$99.00/ea.
TM64CPHTC (Convertible)	\$99.00/ea.
TM64CPTPC (Convertible)	\$99.00/ea.

1964 Fury & Sport Fury

TM64CFGP (Hardtop)	\$99.00/ea.
TM64CFHT (Hardtop)	\$99.00/ea.
TM64CFTP (Hardtop)	\$99.00/ea.
TM64CFGPC (Convertible)	\$99.00/ea.
TM64CFHTC (Convertible)	\$99.00/ea.
TM64CFTPC (Convertible)	\$99.00/ea.

TRUNK MATS

C-BODY MODELS

1965-66 Fury I, II, III & Sport Fury

TM65CFGP (Sedan & Hardtop)	\$99.00/ea.
TM65CFHT (Sedan & Hardtop)	\$99.00/ea.

1965 Fury III & Sport Fury

TM65CFGPC (Convertible)	\$99.00/ea.
TM65CFHTC (Convertible)	\$99.00/ea.

1966 Fury III & Sport Fury

TM66CF(C)C (Convertible)	\$99.00/ea.
--------------------------------	-------------

1967 Fury III & Sport Fury

TM67CFGP (Hardtop)	\$99.00/ea.
TM67CFHT (Hardtop)	\$99.00/ea.
TM67CFTP (Hardtop)	\$99.00/ea.
TM67CFGPC (Convertible)	\$99.00/ea.
TM67CFHTC (Convertible)	\$99.00/ea.
TM67CFTPC (Convertible)	\$99.00/ea.

1967 Polara & Monaco

TM67CPGP (Hardtop)	\$99.00/ea.
TM67CPHT (Hardtop)	\$99.00/ea.
TM67CPGPC (Convertible)	\$99.00/ea.
TM67CPHTC (Convertible)	\$99.00/ea.

1968 Chrysler 300, Newport & New Yorker

1968 Polara & Monaco

1968 Fury III & Sport Fury

TM68CFMPGP (Hardtop)	\$99.00/ea.
TM68CFMPHT (Hardtop)	\$99.00/ea.
TM68CFGPC (Convertible)	\$99.00/ea.
TM68CFHTC (Convertible)	\$99.00/ea.

☞ Conv. trunk mat not for 1968 Polara & Monaco models.

1969 Fury III & Sport Fury

TM69CF4GP (Hardtop)	\$99.00/ea.
TM69CF4GPC (Convertible)	\$99.00/ea.

1969-70 Chrysler 300

TM69CMGP (Hardtop)	\$99.00/ea.
TM69CMHB (Hardtop)	\$99.00/ea.
TM69CMHT (Hardtop)	\$99.00/ea.
TM69CMGPC (Convertible)	\$99.00/ea.
TM69CMHBC (Convertible)	\$99.00/ea.

1970 Fury III & Sport Fury

TM70CFHB (Hardtop)	\$99.00/ea.
TM70CFHBC (Convertible)	\$99.00/ea.

SPARE TIRE COVER



Add the finishing touch to your trunk with a spare tire cover to match your trunk mat. Made from the same trunk mat material, these covers will fit any vehicle with a floor mounted spare tire. Please specify material pattern at time of order.

ST14-15GP (Gray Plaid)	\$65.00/ea.
ST14-15HT (Houndstooth)	\$65.00/ea.
ST14-15HB (Herringbone)	\$65.00/ea.
ST14-15TP (Tan Plaid)	\$65.00/ea.

☞ 1970 and later A, B & E-Body models used Herringbone.

TRUNK MAT MATERIAL

Legendary Auto Interiors offers an uncut roll of trunk mat material in Houndstooth, Gray or Tan Plaid and Herringbone for models not offered. You cut to size this 52" x 80" roll.

TMROLLHT (Houndstooth)	\$99.00/ea.
TMROLLGP (Gray Plaid) (shown)	\$99.00/ea.
TMROLLTP (Tan Plaid)	\$99.00/ea.
TMROLLHB (Herringbone)	\$99.00/ea.



TRUNK DIVIDERS & JUTE INSULATION

Die-cut reproduction of the black fiberboard panel that separates the rear seat from the trunk compartment.
Die-cut jute Insulation helps reduce the amount of noise and heat from the trunk compartment.

B-BODY MODELS

1963 Chrysler B-Body

TD63CFPRW ⁰⁵¹..... \$41.00/ea.
TD63CFPRWJ (jute insulation) \$39.00/ea.

1964 Chrysler B-Body

TD64CFPRW ⁰⁵¹..... \$41.00/ea.
TD64CFPRWJ (jute insulation) \$39.00/ea.

C-BODY MODELS

1963 Chrysler 300

TD63CM ⁰⁵¹..... \$41.00/ea.

1965 Polara

1965 Fury III & Sport Fury

TD65CFP ⁰⁵¹..... \$41.00/ea.
TD65CFPJ (jute insulation) \$34.00/ea.

1965 Fury I & Fury II

TD65CF (Sedan) ⁰⁵¹..... \$45.00/ea.
TD65CFPJ (jute insulation) \$34.00/ea.

1967 Fury III & Sport Fury

TD67CF ⁰⁵¹..... \$59.00/ea.
TD67CFJ (jute insulation)..... \$34.00/ea.



TRUNK SIDE PANEL COVERS

Die-cut reproduction side panels made of black fiberboard dress-up the trunk compartment by concealing the inner quarter panels.



1963 Polara ⁰⁵³

TP63CP (Hardtop - 4 pc.)..... \$143.00/kit
TP63CPC (Convertible - 4 pc.)..... \$143.00/kit

1963 Fury & Sport Fury ⁰⁵³

TP63CF (Hardtop - 4 pc.)..... \$143.00/kit
TP63CFC (Convertible - 4 pc.)..... \$143.00/kit

TRUNK FLOOR FILLER BOARDS

Die-cut reproduction trunk boards fill in the area between the trunk floor outer edges and inner quarter panels.



1962 Dodge B-Body (all models)

TB62CLP (Htp/Conv. - 2 pc.) \$32.00/kit

1963-64 Dodge B-Body (all models)

TB63CP (Htp/Conv. - 2 pc.) \$32.00/kit

1963-64 Fury & Sport Fury

TB63CF (Htp/Conv. - 2 pc.) \$54.00/kit

1964 Dodge B-Body (all models)

TB64CPW (Htp/Conv. - 2 pc.) \$49.00/kit



Providing the automotive industry
with the world's highest quality
soft trim products and services
RIGHT HERE AT HOME

STILL ASSEMBLED AND
MADE IN THE ★★★★★
USA 

THERE REALLY IS A DIFFERENCE!!



Legendary
AUTO INTERIORS LTD.®



www.legendaryautointeriors.com





VINYL TOPS CONVERTIBLE TOPS AND ACCESORIES

 facebook.com/legendaryautointeriors
 twitter.com/legendaryautoin

 www.legendaryautointeriors.com
 instagram.com/legendaryautointeriorsltd
 youtube.com/user/legendaryauto



VINYL TOPS

Legendary Auto Interiors, Ltd. "fitted" vinyl tops are manufactured to original specifications with the correct 100% cotton drill backing that gives trouble free installation and long term durability. All seams are double stitched and die-electrically heat-sealed insuring accurate deck width and seam durability. Each top is individually cut and fit for each specific year, make and model to give that perfect Legendary fit. Every Legendary vinyl top carries a (5) year factory warranty, the best in the industry!!

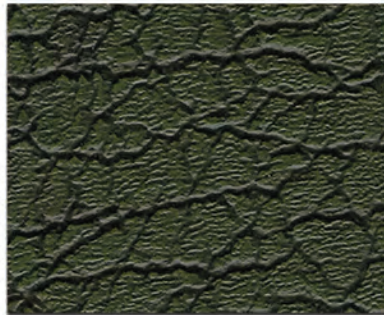

Boar Grain
(1967-74)



ORIGINAL REPRODUCTION BOAR GRAIN



01 - Black



02 - White

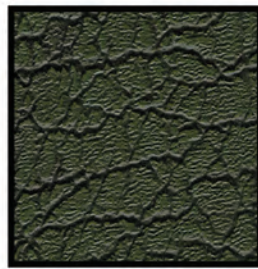

03 - Antique Green

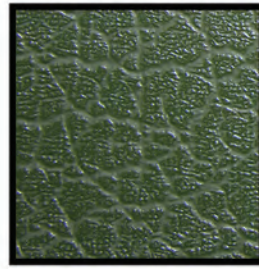

13 - Green



22 - Pearl White

Chrysler, Dodge, Plymouth C-Body

VINYL TOPS

1967-68 Newport, New Yorker, 300

1967-68 Monaco, Monaco 500, Polara & Polara 500

1967-68 Fury, Sport Fury, VIP

VTL119MP01 (45" center deck width w/ pillar post & <u>no</u> valance).....	\$539.00/ea.
VTL119MP02 (45" center deck width w/ pillar post & <u>no</u> valance).....	\$539.00/ea.
VTL119MP03 (45" center deck width w/ pillar post & <u>no</u> valance).....	\$539.00/ea.
VTL119MP22 (45" center deck width w/ pillar post & <u>no</u> valance).....	\$539.00/ea.

☞ Fits 2dr. "Fast-Top" models only.

1969-71 Fury, Sport Fury, VIP

VTL116F01 (46" center deck width w/ pillar post & valance).....	\$539.00/ea.
VTL116F02 (46" center deck width w/ pillar post & valance).....	\$539.00/ea.
VTL116F03 (46" center deck width w/ pillar post & valance).....	\$539.00/ea.
VTL116F13 (46" center deck width w/ pillar post & valance).....	\$599.00/ea. (L4)
VTL116F22 (46" center deck width w/ pillar post & valance).....	\$539.00/ea.

☞ Fits 2dr. "Formal Roof" models with a rear window measurement of 22" x 64" only.

1969-71 Fury, Sport Fury, VIP

1969-71 Monaco, Monaco 500, Polara & Polara 500

VTL16P01 (46" center deck width w/ pillar post & valance).....	\$539.00/ea.
VTL16P02 (46" center deck width w/ pillar post & valance).....	\$539.00/ea.
VTL16P03 (46" center deck width w/ pillar post & valance).....	\$539.00/ea.
VTL16P13 (46" center deck width w/ pillar post & valance).....	\$599.00/ea. (L4)
VTL16P22 (46" center deck width w/ pillar post & valance).....	\$539.00/ea.
VTL16F151 (Gator Grain 46" center deck w/ pillar post & valance) ...	\$1495.00/ea. (L1)

☞ Fits Fury, Sport Fury & VIP 2dr. HTP models with rear window measurement of 24" x 58" only.

1969-71 Newport, New Yorker & 300

VTL18M01 (46" center deck width w/ pillar post & valance).....	\$539.00/ea.
VTL18M02 (46" center deck width w/ pillar post & valance).....	\$539.00/ea.
VTL18M03 (46" center deck width w/ pillar post & valance).....	\$539.00/ea.
VTL18M13 (46" center deck width w/ pillar post & valance).....	\$599.00/ea. (L4)
VTL18M22 (46" center deck width w/ pillar post & valance).....	\$539.00/ea.

☞ Fits Newport, New Yorker & 300 2dr. HTP models with rear window measurement of 24" x 58" only.

1972-73 Newport & New Yorker

1972-73 Monaco & Polara

1972-73 Fury, Sport Fury & Gran Coupe

VTL19F01 (46" center deck width w/ pillar post & valance).....	\$539.00/ea.
VTL19F02 (46" center deck width w/ pillar post & valance).....	\$539.00/ea.
VTL19F13 (46" center deck width w/ pillar post & valance).....	\$539.00/ea. (L4)

NOS VINYL TOPS

Chrysler offered special order vinyl top colors and grain options such as Gator, Tortoise, Gold Reptile and Mod along with many others that are no longer manufactured and have not been reproduced. In our efforts to better serve you in your restoration needs, NOS (New Old Stock) vinyl top material is continuously being looked for. Please call for more information.

VTNOS \$1129.00/ea.

☞ Please specify year/make/model, color, grain, with or without pillar posts, with or without rear valance & center deck width at time of order.

VINYL TOP TERMINOLOGY

Pillar post - The "A" pillar connects the roof to the body located between the windshield and door window. A vinyl top with pillar post runs all the way down the pillar to the bottom of the windshield.



Valance - This is the area under the rear window. If you have a vinyl top with a valance, then the vinyl top would wrap around the underside of the rear window.



Center Deck - The distance between the roof top seams measuring from the center of left seam (driver side) to the center of right seam (passenger side).



COLOR CODES & YEARS APPLICABLE

(01) Black (1966-1974)	(13) Green (1971-1973) (L4)
(02) White (1966-1967 & 1970-74)	(22) Pearl White (1968-1969)
(03) Antique Green (1968-1970)	



CONVERTIBLE TOPS AND ACCESSORIES



Legendary Auto Interiors, Ltd. convertible tops are reproduced to factory original specifications. Convertible tops are available in original KV "Pinpoint" grain (1962-67 models) and Crush "Colonial" grain (1968-70 models). Convertible tops are handcrafted using correct heavyweight 36oz. material. Rear window curtains are available in glass or plastic depending on year, make and model. We also have convertible tops available for most 1950 to present models. For colors other than black and white and models not listed, please call for assistance. As with all Legendary Auto Interiors, Ltd. products, these reproduction convertible tops are the finest available and come with a (2) year manufacturer's warranty (glass curtains come with (1) year warranty) against defects in materials and workmanship.

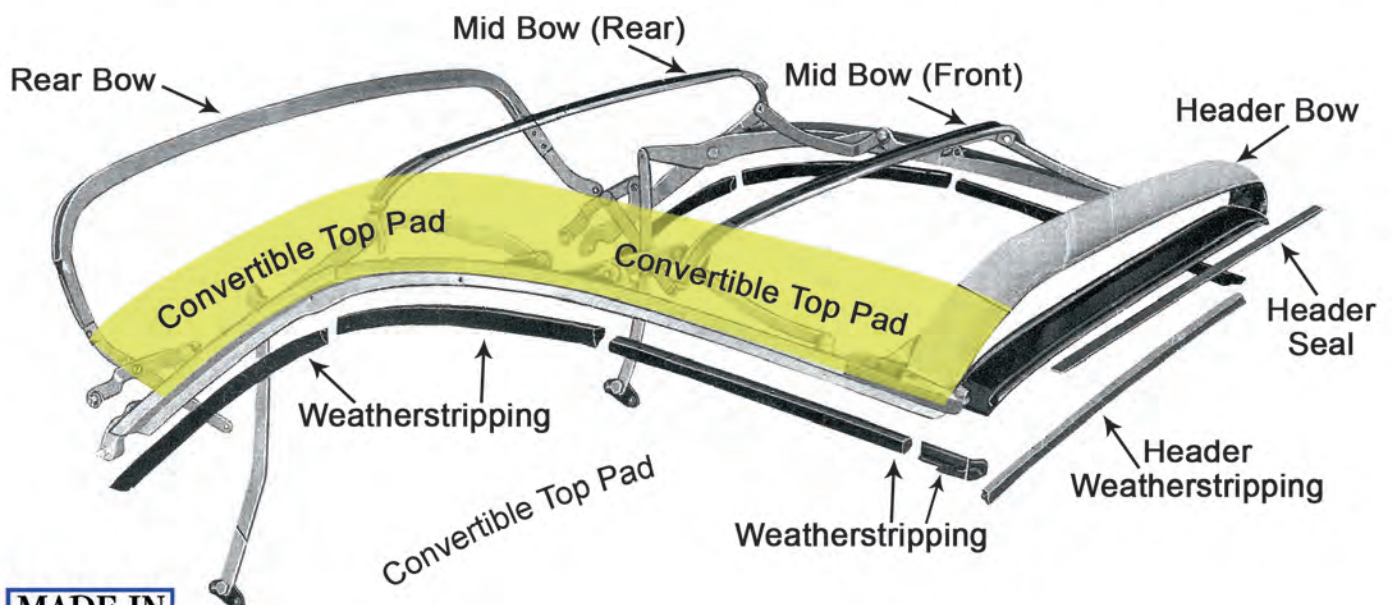

Convertible Top Color Samples

K.V. "Pinpoint Grain" (1962-67)



01 Black

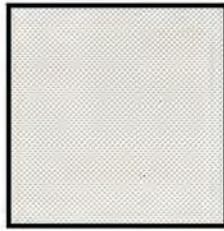

02 White

Crush Grain (1968-70)



01 Black



02 White

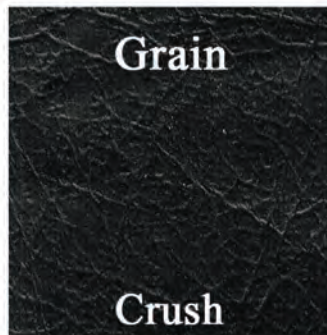
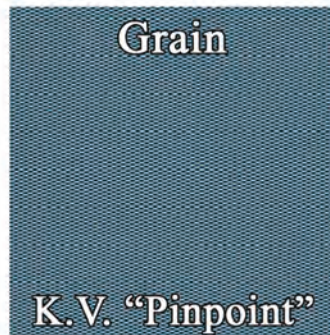

CONVERTIBLE TOPS

B-BODY MODELS

1962 Polara & Polara 500

1962 Fury & Sport Fury

CT62CFLP(C)T (Black and White only) ..\$459.00/ea.

CT62CFLP-P (Plastic curtain only)\$279.00/ea.

1963 Polara & Polara 500

1963 Fury & Sport Fury

CT63CFP(C)T (Black and White only)\$459.00/ea.

CT63CFP(C)P (Plastic curtain only)\$279.00/ea.

1964 Polara, Polara 500, Fury, Sport Fury

CT64CFPRW(C)T (Black and White only) ..\$459.00/ea.

CT64CFPRW(C)P (Curtain only).....\$279.00/ea.

C-BODY MODELS

1963-64 Chrysler 300 & Newport

CT63CM(C)T (Black and White only) \$509.00/ea.

CT63CM-P (Plastic curtain only) \$279.00/ea.

1965-66 Chrysler 300 & Newport

1965-66 Polara & Polara 500

1965-66 Fury III & Sport Fury

CT65CMFP(C)T (Black and White only) . \$399.00/ea.

CT65CMFP-P (Plastic curtain only) \$279.00/ea.

1967 Chrysler 300 & Newport

1967 Polara & Polara 500

1967 Fury III & Sport Fury

CT67CFP(C)T (Black and White only) \$399.00/ea.

CG67CF(C) (Glass curtain only) ⁰⁵² ₀₀₋₀₁ . \$399.00/ea.

1968 Chrysler 300 & Newport

1968 Polara & Polara 500

1968 Fury III & Sport Fury

CT68CMFP(C)T (Black and White only) . \$399.00/ea.

CG68CMFP(C) (Glass curtain) ⁰⁵² ₀₀₋₀₁ . \$399.00/ea.

1969-70 Chrysler 300 & Newport

1969-70 Polara

1969-70 Fury III, VIP & Sport Fury

CT69CMFP(C)T (Black and White only) . \$399.00/ea.

CG69CMFP(C) (Glass curtain) ⁰⁵² ₀₀₋₀₁ . \$399.00/ea.

UNIVERSAL CONVERTIBLE
TOP PADS



Universal convertible top pads fit between the top and metal frame rails, protecting the top from wear and damage. These will require some trimming but are a less expensive alternative to the OEM style. For the best possible fit, select your year specific OEM convertible top listed on this page. Convertible top pads are highly recommended with installation of new convertible tops.

CTPAD74STD\$79.00/pr.



Providing the automotive industry
with the world's highest quality
soft trim products and services
RIGHT HERE AT HOME

STILL ASSEMBLED AND
MADE IN THE ★★★★★
USA 

THERE REALLY IS A DIFFERENCE!!

Legendary
AUTO INTERIORS LTD.

www.legendaryautointeriors.com





CONVERTIBLE BOOTS

All A, B, C & E-Body convertible boots are sewn to original factory specifications, using original grain vinyls. 1963-65 boot use Bison grain, 1966-68 use Cologne grain, 1969-71 use Coachman grain (except 1969 Dart GT models use Dakota grain). Each boot includes the correct plastic clips or metal snaps and improved padding. Please specify year, make, model and color code at time of order. On two-tone colored interior models, the boot will always match the skirting material on the upholstery. Please refer to the upholstery section in this catalog for correct color code.



www.legendaryautointeriors.com

CONVERTIBLE BOOTS

All B & C-Body convertible boots are sewn to original factory specifications, using original grain vinyls. 1963-65 boots use Bison grain, 1966-68 use Cologne grain, 1969-71 use Coachman grain. Each boot includes the correct plastic clips or metal snaps and improved padding. Please specify year, make, model and color code at time of order. On two-tone colored interior models, the boot will always match the skirting material on the upholstery. Please refer to the upholstery section in this catalog for correct color code.



B-BODY MODELS

1963 Polara & Polara 500

CB63CP00017100 (Black)	\$399.00/ea.
CB63CP00017204 (Dark White)	\$419.00/ea. (L4)
CB63CP00017302 (Blue)	\$399.00/ea.
CB63CP00017406 (Lt Turquoise)	\$399.00/ea.
CB63CP00017510 (Crimson Red)	\$399.00/ea.

1963 Fury & Sport Fury

CB63CRW0017100 (Black)	\$399.00/ea.
CB63CRW0017302 (Blue)	\$419.00/ea. (L4)
CB63CRW0017510 (Crimson Red)	\$399.00/ea.

1964 Polara & Polara 500

1964 Fury & Sport Fury

CB64CRW0017100 (Black)	\$399.00/ea.
CB64CRW0017314 (Lt Met Blue)	\$399.00/ea.
CB64CRW0017416 (Met Turquoise)	\$399.00/ea.
CB64CRW0017510 (Crimson Red)	\$399.00/ea.
CB64CRW0017606 (Dark Copper)	\$419.00/ea. (L4)
CB64CRW0017610 (Metallic Fawn)	\$419.00/ea. (L4)
CB64CRW0017410 (Lt Met Olive)	\$729.00/ea. (L1)

C-BODY MODELS

1963-64 Chrysler 300 & Newport

CB63CM00017100 (Black)	\$469.00/ea.
CB63CM00017202 (Pearl White)	\$469.00/ea.
CB63CM00017204 (Dark White)	\$492.00/ea. (L4)
CB63CM00017206 (Taupe)	\$492.00/ea. (L4)
CB63CM00017314 (Metallic Blue)	\$469.00/ea.
CB63CM00017339 (Metallic Blue)	\$469.00/ea.
CB63CM00017406 (Turquoise)	\$492.00/ea. (L4)
CB63CM00017520 (Metallic Red)	\$469.00/ea.
CB63CM00017530 (Claret Red)	\$469.00/ea.
CB63CM00017610 (Metallic Fawn)	\$492.00/ea. (L4)

1965 Polara & Polara 500

1965 Fury III & Sport Fury

CB65CFP0017100 (Black)	\$469.00/ea.
CB65CFP0017314 (Met Blue)	\$469.00/ea.
CB65CFP0017320 (Metallic Navy)	\$469.00/ea.
CB65CFP0017414 (Dk Met Turq)	\$469.00/ea.
CB65CFP0017520 (Metallic Red)	\$469.00/ea.
CB65CFP0017614 (Gold)	\$469.00/ea.

1965 Chrysler 300 & 300L

CB65CM00017100 (Black)	\$469.00/ea.
CB65CM00017202 (Peral White)	\$469.00/ea.
CB65CM00017322 (Met Blue)	\$469.00/ea.
CB65CM00017520 (Metallic Red)	\$469.00/ea.
CB65CM00017610 (Metallic Fawn)	\$492.00/ea. (L4)
CB65CM00017614 (Gold)	\$469.00/ea.

1966 Polara & Polara 500

1966 Fury III & Sport Fury

1966 Chrysler 300

CB66CFP0017100 (Black)	\$469.00/ea.
CB66CFP0017102 (Silver)	\$469.00/ea.
CB66CFP0017202 (Pearl White)	\$469.00/ea.
CB66CFP0017318 (Lt Met Blue)	\$469.00/ea.
CB66CFP0017320 (Met Navy)	\$469.00/ea.
CB66CFP0017420 (Citron)	\$469.00/ea. (L4)
CB66CFP0017520 (Metallic Red)	\$469.00/ea.
CB66CFP0017614 (Gold)	\$469.00/ea.
CB66CFP0017616 (Ginger)	\$469.00/ea.

1967-68 Fury III & Sport Fury

CB67CF00017100 (Black)	\$469.00/ea.
CB67CF00017202 (Pearl White)	\$469.00/ea.
CB67CF00017318 (Lt Met Blue)	\$469.00/ea.
CB67CF00017332 (Lt Met Blue)	\$469.00/ea.
CB67CF00017430 (Dk Met Green)	\$469.00/ea.
CB67CF00017520 (Metallic Red)	\$469.00/ea.
CB67CF00017620 (Copper)	\$469.00/ea.

C-BODY MODELS CONT.

1967-68 Chrysler 300 & Newport

CB67CM00017100 (Black)	\$469.00/ea.
CB67CM00017202 (Pearl White)	\$469.00/ea.
CB67CM00017318 (Lt Met Blue)	\$469.00/ea.
CB67CM00017330 (Dk Met Blue)	\$469.00/ea.
CB67CM00017520 (Metallic Red)	\$469.00/ea.

* Due to vinyl length restrictions we are unable to reproduce (330) Dark Metallic Blue convertible boots in original Cologne grain without adding a non-original center seam.

1967-68 Polara & Polara 500

CB67CP00017100 (Black)	\$469.00/ea.
CB67CP00017202 (Pearl White)	\$469.00/ea.
CB67CP00017318 (Lt Met Blue)	\$469.00/ea.
CB67CP00017332 (Lt Met Blue)	\$469.00/ea.
CB67CP00017520 (Metallic Red)	\$469.00/ea.

1969-70 Chrysler 300 & Newport

CB69CM00017100 (Black)	\$469.00/ea.
CB69CM00017200 (White)	\$469.00/ea.
CB69CM00017332 (Lt Met Blue)	\$469.00/ea.
CB69CM00017336 (Navy Blue)	\$469.00/ea.
CB69CM00017434 (Dk Met Green)	\$469.00/ea.
CB69CM00017650 (Saddle)	\$469.00/ea.
CB69CM00017656 (Brown)	\$469.00/ea.

1969 Polara & Polara 500

1969 Fury III & Sport Fury

CB69CFP0017100 (Black)	\$469.00/ea.
CB69CFP0017200 (White)	\$469.00/ea.
CB69CFP0017330 (Dk Met Blue)	\$469.00/ea.
CB69CFP0017332 (Lt Met Blue)	\$469.00/ea.
CB69CFP0017432 (Lt Met Green)	\$469.00/ea.
CB69CFP0017528 (Red)	\$469.00/ea.

1970 Polara

1970 Fury III

CB70CFP0017100 (Black)	\$469.00/ea.
CB70CFP0017154 (Charcoal)	\$469.00/ea.
CB70CFP0017332 (Lt Met Blue)	\$469.00/ea.
CB70CFP0017432 (Lt Met Green)	\$469.00/ea.
CB70CFP0017434 (Dk Met Green)	\$469.00/ea.



CONVERTIBLE WELL LINERS

Legendary Auto Interiors, Ltd. convertible top well liners for A, B, C & E-Body models are manufactured to original specifications with plastic strips and snaps (where applicable) for easy installation. The well liner installs behind the convertible rear seat protecting the top from damage when placed in the down position. Available in black for all years or in matching colors for 1963-65 model interiors.



B-BODY MODELS

1963 Polara & Polara 500

- WL63CP00016100 (Black).....\$229.00/ea.
- WL63CP00016206 (Taupe).....\$240.00/ea. (L4)
- WL63CP00016302 (Blue).....\$240.00/ea. (L4)
- WL63CP00016406 (Lt Turquoise).....\$240.00/ea. (L4)
- WL63CP00016510 (Crimson Red).....\$229.00/ea.

1963 Fury & Sport Fury

- WL63CFR0016100 (Black).....\$229.00/ea.
- WL63CFR0016302 (Blue).....\$240.00/ea. (L4)
- WL63CFR0016510 (Crimson Red).....\$229.00/ea.

1964 Polara & Polara 500

1964 Fury & Sport Fury

- WL64CRW0016100 (Black).....\$229.00/ea.
- WL64CRW0016314 (Lt Met Blue).....\$229.00/ea.
- WL64CRW0016416 (Met Turq).....\$229.00/ea.
- WL64CRW0016510 (Crimson Red).....\$229.00/ea.
- WL64CRW0016606 (Dark Copper).....\$240.00/ea. (L4)
- WL64CRW0016610 (Metallic Fawn).....\$240.00/ea. (L4)
- WL64CRW0016410 (Met Olive).....\$530.00/ea. (L1)

C-BODY MODELS

1963-64 Chrysler 300 & Newport

- WL63CM00016100 (Black).....\$275.00/ea.
- WL63CM00016206 (Taupe).....\$289.00/ea. (L4)
- WL63CM00016314 (Metallic Blue).....\$275.00/ea.
- WL63CM00016339 (Metallic Blue).....\$275.00/ea.
- WL63CM00016406 (Turquoise).....\$289.00/ea. (L4)
- WL63CM00016520 (Metallic Red).....\$275.00/ea.
- WL63CM00016530 (Claret Red).....\$275.00/ea.
- WL63CM00016610 (Metallic Fawn).....\$289.00/ea. (L4)

1965-66 Chrysler 300 & Newport

1965-66 Polara & Polara 500

1965-66 Fury III & Sport Fury

- WL65CFMP016100 (Black).....\$275.00/ea.
 - WL65CFMP016314 (Met Blue).....\$275.00/ea.
 - WL65CFMP016320 (Met Navy).....\$275.00/ea.
 - WL65CFMP016322 (Med Met Blue).....\$275.00/ea.
 - WL65CFMP016414 (Dk Met Turq).....\$275.00/ea.
 - WL65CFMP016520 (Metallic Red).....\$275.00/ea.
 - WL65CFMP016610 (Met Fawn).....\$289.00/ea. (L4)
 - WL65CFMP016614 (Gold).....\$275.00/ea.
- ☞ 1966 models available in black only.

1967-68 Chrysler 300 & Newport

- WL67CM00016100 (Black).....\$275.00/ea.
- ☞ Available in black only.

1967-68 Fury III & Sport Fury

- WL67CF00016100 (Black).....\$275.00/ea.
- ☞ Available in black only.

1969-70 Chrysler 300 & Newport

- WL69CM00016100 (Black).....\$275.00/ea.
- ☞ Available in black only.

1969-70 Polara & Polara 500

1969-70 Fury III & Sport Fury

- WL69CFP0016100 (Black).....\$275.00/ea.
- ☞ Available in black only.

CONVERTIBLE BOOT DUST COVER

Protect your convertible boot when you remove it with this convertible boot dust cover made in Levant grain with a satin finish. Comes in Black only



- CB67MCBAG01.....\$39.00/ea.

CONVERTIBLE TOP LATCH



1965-68 C-Body & 1966-70 B-Body convertible top latch

- CT65ABC-LATCH.....\$169.00/pr.

CONVERTIBLE BODY SCREW STUDS



5/8" Phillips head stainless steel body screw studs for snap down boot and well liner applications.

- CBBOOTBEZSCRW (Pkg/35)\$16.00/pk.



Providing the automotive industry
with the world's highest quality
soft trim products and services
RIGHT HERE AT HOME

STILL ASSEMBLED AND
MADE IN THE ★★★★★
USA 

THERE REALLY IS A DIFFERENCE!!



Legendary
AUTO INTERIORS LTD.



www.legendaryautointeriors.com





WEATHERSTRIPING AND ACCESORIES

 facebook.com/legendaryautointeriors
 twitter.com/legendaryautoin

 www.legendaryautointeriors.com
 instagram.com/legendaryautointeriorsltd
 youtube.com/user/legendaryauto

BODY PLUG KITS



Complete body plug kits for floor pans, trunk pans and trunk extensions contain the correct size and style plugs in plastic or rubber depending on location and application of each year and model.

B-BODY MODELS

**1963 Polara & Polara 500
1963 Fury & Sport Fury**
BP63B..... \$59.00/kit

**1964 Polara & Polara 500
1964-65 Fury & Sport Fury**
BP64CF..... \$59.00/kit

BODY BUMPER KITS

Complete body bumper kits for 1963-74 B & C-Body models. These kits include all of the body bumpers on your car from the hood to the trunk. Spring-loaded hood wedges are included in 1969-74 kits where applicable.



B-BODY MODELS

**1964 Fury & Sport Fury
1964 Polara & Polara 500**
BU64CRW-C..... \$29.00/kit

C-BODY MODELS

1968 Newport & 300
BU68CM-C..... \$39.00/kit

1969 Polara & Monaco
BU69CP-C..... \$59.00/kit

1969 Fury III & Sport Fury
BU69CF-C..... \$59.00/kit

1970 Polara & Monaco
BU70CP-C..... \$59.00/kit

1970 Fury III & Sport Fury
BU70CF-C..... \$59.00/kit

1971 Polara & Monaco
BU71CP-C..... \$59.00/kit

1971 Fury III & Sport Fury
BU71CF-C..... \$59.00/kit

1972-74 Polara & Monaco
BU72CP-C..... \$59.00/kit

1972-73 Fury III & Sport Fury
BU72CF-C..... \$59.00/kit

SPRING-LOADED HOOD BUMPERS

Spring-loaded hood bumpers for 1971-74 B-Body and 1969-74 C-Body models. This wedge-shaped bumper keeps the hood in alignment.



BU69WEDGE..... \$15.00/ea.

TRUNK BUMPER KIT

Rubber bumpers for 1966-74 B & C-Body models keeps the trunk lid in alignment. (NOTE: Contents of this kit are also included in the complete body bumper kits)

BU66ABTRNK..... \$3.00/ea.

HOOD BUMPER KITS

Bumper kit includes all the necessary bumpers for under the hood of your car. (NOTE: Contents of this kit are also included in the complete body bumper kits)

B-BODY MODELS

**1964 Polara & Polara 500
1964 Fury & Sport Fury**
BU64CRW-H..... \$29.00/kit

C-BODY MODELS

**1969-74 Chrysler 300
1969-74 Newport & New Yorker
1969-74 Polara & Monaco
1969-74 Fury III & Sport Fury**
BU69CFPM-H..... \$59.00/kit

DOOR & TRUNK LOCK GASKETS



Gray plastic door and trunk lock gaskets for 1966-71 B & C-Body models mount between the lock mechanism and body.

GK66LOCKDT..... \$5.00/kit

WINDOW TRIM CLIPS



Trim clip kits include both front windshield and rear window clips (where applicable) for fastening trim molding. Mounting screws included.

B-BODY MODELS

**1962 Polara
1962 Fury & Sport Fury**
WG62CFLPRC-CLIP (Convertible)..... \$29.00/kit

**1963 Polara 500
1963 Fury & Sport Fury**
WG63CFPR-CLIP (Hardtop)..... \$39.00/kit
WG62CFLPRC-CLIP (Convertible)..... \$29.00/kit

**1964 Polara & Polara 500
1964 Fury & Sport Fury**
WG64CPRWH-CLIP (Hardtop)..... \$59.00/kit
WG64CPRWS-CLIP (Sedan)..... \$59.00/kit
WG64CPRWC-CLIP (Convertible)..... \$39.00/kit

WINDSHIELD GASKETS

Remanufactured rubber windshield gaskets made as original for B, C-Body and Dodge pickups.

B-BODY MODELS

**1962-63 Polara & Polara 500
1962-63 Fury & Sport Fury**
WG62CRW-WG (Hardtop)..... \$119.00/ea.

**1964 Polara & Polara 500
1964 Fury & Sport Fury**
WG64CRW-WG (Hardtop)..... \$119.00/ea.
WG64CFPRW-WG (Convertible)..... \$119.00/ea.

C-BODY MODELS

**1965-66 Chrysler 300
1965-66 Newport & New Yorker
1965-66 Polara, Polara 500 & Monaco
1965-68 Fury III & Sport Fury**
WG65CFMP-WG (2-door Hardtop) .. \$119.00/ea.

**1965-68 Chrysler 300
1965-68 Newport & New Yorker
1965-68 Polara & Polara 500
1965-68 Fury III & Sport Fury**
WG65CFMP-WG (Convertible)..... \$119.00/ea.

**1965-68 Chrysler 300
1965-68 Newport & New Yorker
1965-68 Polara & Monaco
1965-68 Fury II & Fury III**
WG65CFMP-WG (4-door Hardtop) .. \$119.00/ea.

DODGE TRUCK

1972-93 Dodge Pickup
WG72CDT-WG..... \$119.00/ea.



HARDTOP / SEDAN WEATHERSTRIPPING

CONVERTIBLE WEATHERSTRIPPING

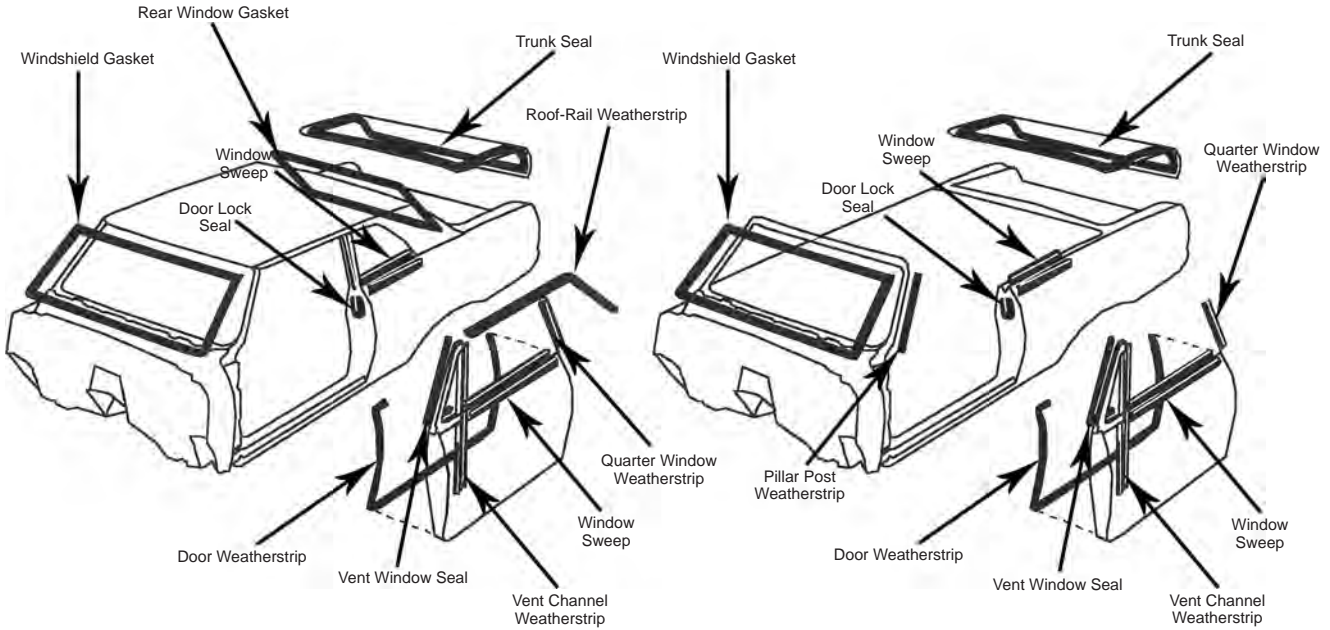

ROOF RAIL WEATHERSTRIPPING

Thick molded rubber with correct molded endpads. These start at the base of the windshield pillar post and follow along the outer edge of the roofline to the rear of the quarter window.

- 1962-63 B-Body (all models)**
WS62C-BROOF (Hardtop).....\$189.00/pr.
1964 B-Body (all models)
WS64C-BROOF (Hardtop).....\$159.00/pr.

DOOR WINDLACE WEATHERSTRIP

Reproduction door windlace with steel core for 1962-65 2-Door models. This windlace pushes onto the lip of the door jamb sealing the doors when shut.

- WS62C-DOOR(C) (Hardtop/Conv.)**..... \$169.00
WS62C-SDOOR(C) (Sedan)..... \$209.00
 Available colors: (01) Black, (03) Red, (11) Light Blue, (50) Turquoise.

TRUNK SEALS

Correct original profile extruded foam for hardtop and convertible models seals the trunk lid preventing water leaks.

- 1967-68 C-Body (all models)**
TS67CM (Hardtop & Convertible)..... \$39.00/ea.

REAR WINDOW GASKETS

Remanufactured rubber rear window gaskets made as original for B-Body models where applicable.

B-BODY MODELS

- 1964 Polara & Polara 500**
1964 Fury & Sport Fury
WG64CRWH-RG (Hardtop) \$119.00/ea.
WG64CRW-RG (Sedan) \$119.00/ea.

DOOR WEATHERSTRIPPING CLIPS



Plastic door weatherstripping kits replace missing or broken originals. For all 1966 and later models. (NOTE: These clips are replacements only and are already included with the door weatherstripping shown above)

- WS63CDOORCLIPS (22/pkg)**..... \$15.00/pk.

CHRYSLER "V-FOAM" TRUNK SEAL



Extruded "V" shape foam for all 1963-74 models seals the trunk lid preventing water leaks. Please measure original seal for correct footage when ordering.

- TS63VFOAM**.....\$6.00/ft.

VENT CHANNEL WEATHERSTRIPPING



U-shaped strip that fits on the backside of the vent window channel where the door window rolls up into.

- 1962-63 B-Body (all models)**
WS62C-BVENT38 (Hardtop)..... \$69.00/pr.
1962-64 B-Body (all models)
WS62C-BVENT39 (Sedan)..... \$69.00/pr.
1964 B-Body (all models)
WS64C-BVENT30.5 (Hardtop)..... \$99.00/pr.

VENT WINDOW SEAL



Rubber "wing" vent window seal fits inside the framing for the glass vent window.

- 1978-1986 Dodge Pickup**
WS78D150VENTSEAL..... \$59.00/ea.

CONVERTIBLE TOP FRAME WEATHERSTRIPPING

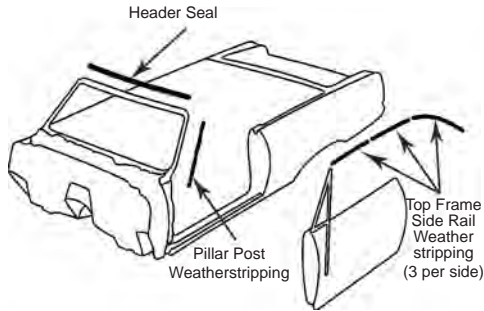

CONVERTIBLE TOP FRAME WEATHERSTRIPPING KITS

Complete convertible top frame kits consist of (1) rubber header seal, (1) secondary rubber header seal and (6) molded rubber side rail pieces.

1962-65 B-Body (all models)

WS62CFPRWTOP \$299.00/kit

HEADER SEALS

Rubber header seal runs along the front of the top and seals against the top of the windshield.

1962-64 B-Body (all models)

WS62CFPRWHS..... \$119.00/ea.

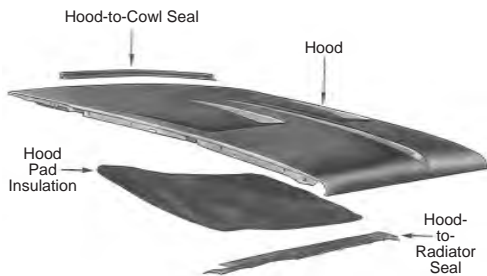

HOOD-TO-COWL SEALS



This rubber piece seals to the underside of the hood to the front edge of the cowl.

1962-64 B-Body (all models)

WS62C-BHOOD.....\$89.00/ea.

HOOD-TO-RADIATOR SEALS



Correctly formed and shaped rubber strip that seals the hood to the radiator core support.

1962-64 B-Body "Narrow Type"

WS62CRW-HRN (w/ clips installed) \$129.00/ea.

1962-64 B-Body "Wide Type"

WS62CRW-HRW (w/ clips installed)..... \$59.00/ea.

HOOD PAD INSULATION

Die-cut reproductions of the original hood insulation pads ready to install. Clips not included.



B-BODY MODELS

1963-64 Fury & Sport Fury

HP63CF1 (1" thick) \$54.00/ea.

HP63CF1/2 (1/2" thick)..... \$43.00/ea.

OS3 1963 requires 16 clips, 1964 requires 20 clips

1964 Polara & Polara 500

HP64CPW1 (1" thick) (21 clips)..... \$43.00/ea.

HP64CPW1/2 (1/2" thick) (21 clips)..... \$38.00/ea.

C-BODY MODELS

1961-70 Chrysler 300 & Newport

HP62CM (1961-62) (requires 19 clips)..\$43.00/ea.

HP63CM (1963-64) (requires 22 clips)..\$54.00/ea.

HP65CM (1965-68) (requires 26 clips)..\$54.00/ea.

HP69CM (1969-70) (requires 19 clips)...\$43.00/ea.

1965-68 Polara & Polara 500

1965-68 Fury III & Sport Fury

HP65CFP (requires 26 clips)..... \$54.00/ea.

DODGE TRUCK

1967-71 Dodge Truck

HP67CDT \$32.00/ea.

MOLDED HOOD PAD

These pads are molded to the shape of the hood as original. Due to size of these hood pads, they are shipped oversized.



1965-68 C-Body (all models)

HP65CFMPM (requires 26 clips)..... \$165.00/ea.

METAL HOOD PAD CLIPS



Reproductions of the original stamped metal hood pad clips for all 1962-65 and 1966-71 models.

HPCLIP-M62 (1962-65).....\$3.00/ea.

HPCLIP-M (1966-71).....\$3.00/ea.

PLASTIC HOOD PAD CLIPS



Reproduction plastic pad clips for all 1972 and later models.

HPCLIP-P.....\$1.00/ea.

WINDOW SWEEP KITS

Reproduction window sweep kits consist of felt-lined pieces for sealing the side glass to the door or quarter panel. Reproduced as close to original as possible, each kit is model specific and includes the chrome or black metal backing strip. Available in 4 piece kits (outer sweeps only) or complete 6, 8 and 10 piece kits (inner and outer sweeps).



B-BODY MODELS

1962 Polara & Polara 500

WS62WX12708 (Conv.) (8 pc.)	\$119.00/kit
WS62WX22704 (Conv.) (4 pc.)	\$ 89.00/kit
WS62WX12508 (HTP) (8 pc.)	\$139.00/kit
WS62WX22504 (HTP) (4 pc.)	\$ 89.00/kit
WS62WW12608 (Sedan) (8 pc.)	\$119.00/kit
WS62WW22604 (Sedan) (4 pc.)	\$ 89.00/kit

1962 Fury & Sport Fury

WS62WX12708 (Conv.) (8 pc.)	\$119.00/kit
WS62WX22704 (Conv.) (4 pc.)	\$ 89.00/kit
WS62WX12508 (HTP) (8 pc.)	\$139.00/kit
WS62WX22504 (HTP) (4 pc.)	\$ 89.00/kit
WS62WW12608 (Sedan) (8 pc.)	\$119.00/kit
WS62WW22604 (Sedan) (4 pc.)	\$ 89.00/kit

1963 Polara & Polara 500

WS63WX12908 (HTP) (8 pc.)	\$139.00/kit
WS63WX22904 (HTP) (4 pc.)	\$ 79.00/kit

1963 Fury & Sport Fury

WS63WX12908 (HTP) (8 pc.)	\$139.00/kit
WS63WX22904 (HTP) (4 pc.)	\$ 79.00/kit

1964 Polara & Polara 500

WS64WX13008 (HTP) (8 pc.)	\$ 99.00/kit
WS64WX23004 (HTP) (4 pc.)	\$108.00/kit

1964 Fury & Sport Fury

WS64WX13008 (HTP) (8 pc.)	\$ 99.00/kit
WS64WX23004 (HTP) (4 pc.)	\$108.00/kit
☞ Round chrome bead style on inner window sweep.	
WS64WX12810 (HTP) (10 pc.)	\$174.00/kit
WS64WW22804 (HTP) (4 pc.)	\$ 99.00/kit
☞ Flat chrome bead style on inner window sweep.	

1963-64 Polara & Polara 500

WS63WX13108 (Conv.) (8 pc.)	\$119.00/kit
WS63WX23104 (Conv.) (4 pc.)	\$ 79.00/kit
WS63WW13208 (Sedan) (8 pc.)	\$139.00/kit
WS63WW23204 (Sedan) (4 pc.)	\$ 89.00/kit

1963-64 Fury & Sport Fury

WS63WX13108 (Conv.) (8 pc.)	\$119.00/kit
WS63WX23104 (Conv.) (4 pc.)	\$ 79.00/kit
WS63WW13208 (Sedan) (8 pc.)	\$139.00/kit
WS63WW23204 (Sedan) (4 pc.)	\$ 89.00/kit

C-BODY MODELS

1965-68 Chrysler 300

1965-68 Newport & New Yorker	
1965-68 Polara, Polara 500 & Monaco	
1965-68 Fury III & Sport Fury	
WS65WW27504 (Conv.) (4 pc.)	\$ 99.00/kit
WS65WW27404 (HTP) (4 pc.)	\$119.00/kit

1967-68 Chrysler 300

1967-68 Newport & New Yorker	
1967-68 Polara, Polara 500 & Monaco	
1967-68 Fury III & Sport Fury	
WS67WW27604 (Fastop) (4 pc.)	\$119.00/kit

1969-70 Chrysler 300

1969-70 Newport & New Yorker	
WS69WW18008 (Conv.) (8 pc.)	\$179.00/kit
WS69WW28004 (Conv.) (4 pc.)	\$119.00/kit
WS69WW17908 (HTP) (8 pc.)	\$179.00/kit
WS69WW27904 (HTP) (4 pc.)	\$119.00/kit

1969-70 Polara, Polara 500 & Monaco

WS69WW17708 (Conv.) (8 pc.)	\$179.00/kit
WS69WW27704 (Conv.) (4 pc.)	\$119.00/kit
WS69WW17908 (HTP) (8 pc.)	\$179.00/kit
WS69WW27904 (HTP) (4 pc.)	\$119.00/kit

1969-70 Fury III & Sport Fury

WS69WW17708 (Conv.) (8 pc.)	\$179.00/kit
WS69WW27704 (Conv.) (4 pc.)	\$119.00/kit
WS69WW17908 (HTP) (8 pc.)	\$179.00/kit
WS69WW27904 (HTP) (4 pc.)	\$119.00/kit

1971 Chrysler 300,

Newport & New Yorker	
WS69WW17908 (HTP) (8 pc.)	\$179.00/kit
WS69WW27904 (HTP) (4 pc.)	\$119.00/kit

1971 Polara & Monaco

WS69WW17908 (HTP) (8 pc.)	\$179.00/kit
WS69WW27904 (HTP) (4 pc.)	\$119.00/kit

1971 Fury III & Sport Fury

WS69WW17908 (HTP) (8 pc.)	\$179.00/kit
WS69WW27904 (HTP) (4 pc.)	\$119.00/kit

DODGE TRUCK MODELS

1973-79 Warlock & Lil' Red Express

WS76WX15504 (4 pc.)	\$129.00/kit
---------------------	--------------

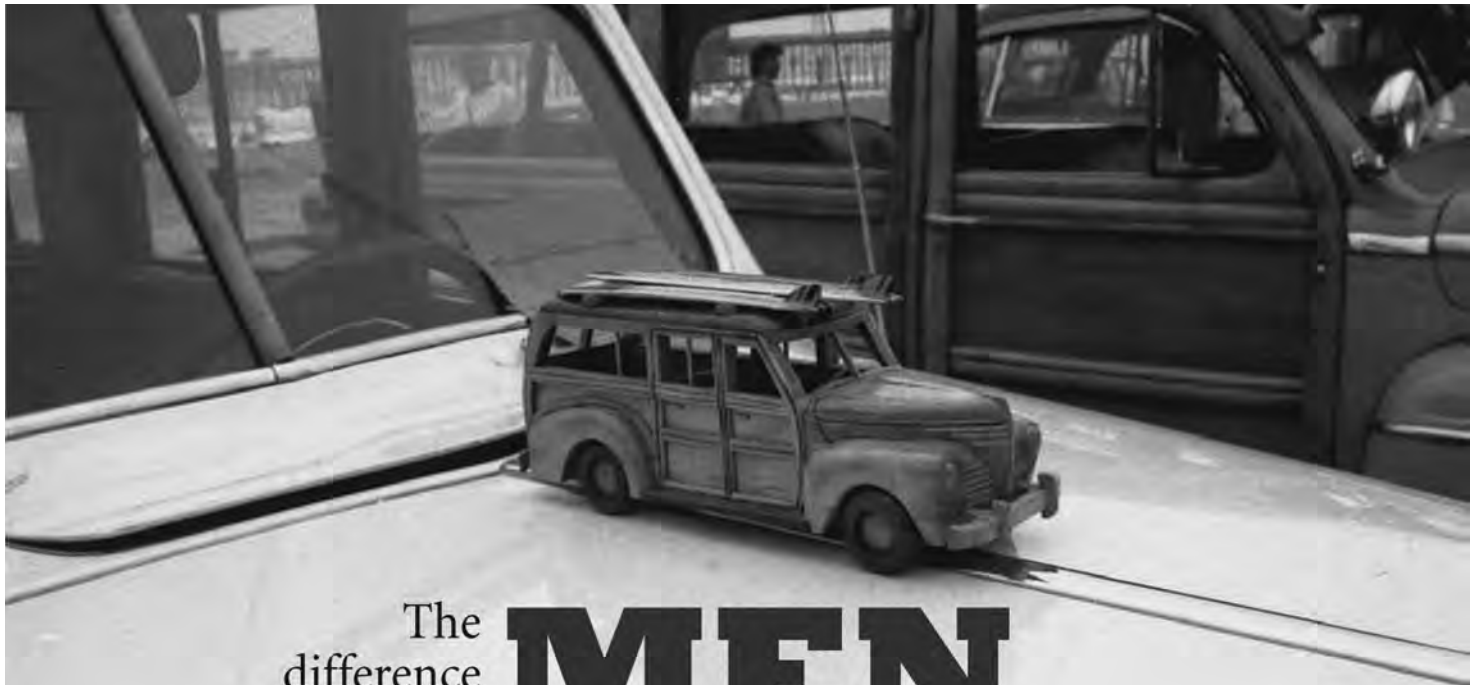

The
difference
between

MEN

& Boys

*is the size of
their toys!*

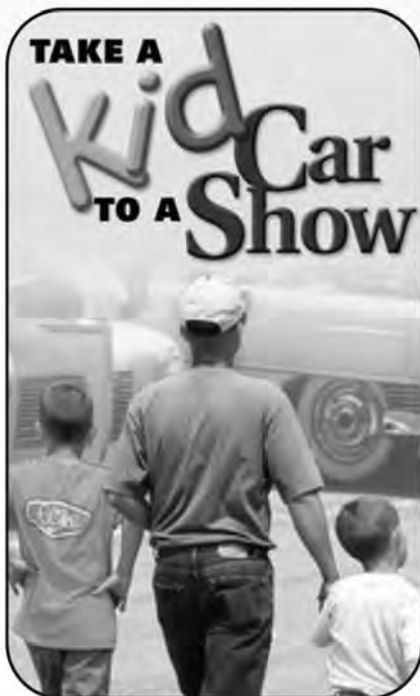

Even if there is a generation or two between you and a child, collector cars can be a terrific common ground. Your enthusiasm and knowledge could be the spark of a new lifelong passion. Bring kids to *your* playground...a car show...and have fun.

Life is full of choices for kids. You can help them make the right ones by sharing your appreciation for cool old cars. (And a kid might even call you “cool” too!)



For more information and a list of upcoming automotive events, visit our website:
www.TakeAKidToACarShow.com

909/396-0289 • tkcs@sema.org

Take a Kid to a Car Show is a program of ARMO, the Automotive Restoration Market Organization, a SEMA Council.

ORDERING INFORMATION

HOW TO ORDER

MAIL, PHONE OR FAXES – When ordering by mail, please fill in all information on the order form that pertains to your vehicle. Print all information and include a telephone number where you can be reached during the day and evening. When ordering for more than one vehicle, please use separate order forms for each vehicle (see order forms in your Legendary Auto Interiors catalog). When ordering by phone, please have your customer number and a list of items ready. You may order conveniently by phone 8:00AM to 6:00PM EST Monday-Friday. Orders may also be sent in by fax 24 hours a day, 7 days a week. Please note that orders faxed in on Saturday or Sunday will not be received and processed until Monday. FAX: 1-800-732-8874

ON-LINE ORDERING – Legendary Auto Interiors, Ltd also offers convenient and easy on-line ordering 24 hours a day, 7 days a week at www.legendaryautointeriors.com. Click on the “Shop Online” tab in the options menu and follow the ordering procedures. Upon completion, Legendary Auto Interiors, Ltd will follow up with an email confirmation so you can verify that your order has been received correctly and is being processed. You may also choose to email your orders by contacting our sales department at sales@legendaryautointeriors.com.

METHODS OF PAYMENT

CREDIT CARDS – Legendary Auto Interiors, Ltd accepts Visa, MasterCard, American Express and Discover for your convenience. Please include the cardholder’s name, billing address, home and business phone, credit card number, expiration date and the 3 or 4 digit security code when placing your orders. Without this information it may slow the processing of your order.

CHECKS AND MONEY ORDERS – Personal Checks will be held 5 business days. To expedite your orders, we suggest paying by Certified Bank Check or Money Order. COD orders are no longer accepted. All payments MUST be in U.S. funds.

SHIPPING SERVICES

DOMESTIC SHIPPING - Legendary Auto Interiors Ltd utilizes both UPS and FedEx Ground for most U.S. parcel shipments which provides our customers the most efficient and cost effective shipping services available. We will ship by the best method for your geographic area unless otherwise specified. We also offer specialized shipping services such as 3 day Select, 2nd day air and Next Day Air for your convenience.

INTERNATIONAL SERVICES – We use the most current and most cost effective international parcel shipping companies available to provide both “Door to Airport” and “Door to Door” services to our overseas customers. We utilize UPS Canadian and FedEx International for Canadian shipments. This provides us with the best possible shipping and brokerage fees for our international customers.

DAMAGES AND SHORTAGES

The carrier is responsible for any merchandise lost or damaged in transit. **Should a package appear to be damaged, OPEN the package while the carrier’s driver is present and note all damages and/or shortages.** If this is not possible and you discover damaged goods or shortages, contact our Customer Service Department immediately! Damages and/or shortage claims must be made within 5 days of receipt of merchandise to ensure our ability to file a claim with the carrier. Please be sure to check all merchandise when you receive it and again before attempting installation.

Legendary Auto Interiors, Ltd. is committed to providing the highest possible level of customer service, however on rare occasions circumstances beyond our control can result in lost or damaged packages. To protect our customers against delays and having to make time consuming phone calls to the carrier, orders will incur a modest \$2.50 insurance fee on each shipment. In the event any products become lost or damaged we will then send replacement parts as quickly as possible, subject to material availability. We will also file the claims and deal with the carrier.

Carriers allow a short period of time to file claims. To take advantage of this service you must notify Legendary Auto Interiors, Ltd. of any damages within 5 days of receiving your delivery. Failure to contact us within this 5 day window will negate Legendary Auto Interiors further involvement.

RETURN POLICY

Legendary Auto Interiors Ltd. will accept returns within the first 30 days of the original invoice date. All items returned within the first 30 days will be subject to a restocking fee of 20-25% depending on item. No returns will be accepted after 30 days. Custom, Special Orders, Specialty Run Materials, Leather and NOS are not eligible for return under any circumstances other than a manufacturing defect. If any product is modified, altered, painted, installed or disassembled in any way without Legendary’s expressed written permission, the item is non-returnable. Legendary always recommends professional installation on all products. Any item which has been altered, painted, installed or deemed non-resalable by Legendary will be returned to the customer at the customer’s expense. Legendary is not responsible or liable for labor fees associated with the installation, modification or repair of any product purchased regardless of the circumstances.

RETURN GOOD INFORMATION

All returns must receive prior approval and an RMA (Return Merchandise Authorization) number prior to return shipping. Packages received by Legendary Auto Interiors Ltd. without prior approval and RMA number will be refused. Return shipping and insurance are the customer’s responsibility. All returned items must be received in as new condition. Examples that render a product non-returnable include, but are not limited to: evidence of attempted installation, parts that have been bent, broken, creased, scratched, soiled, melted or discolored. Also, we will not accept returns for any items that have been altered, painted, repaired or for any reason that has rendered the product non-resalable. Warning: Legendary is not responsible for damaged or lost packages returned by the customer.

CANADIAN CUSTOMER RETURNS

Warranty returns must be clearly marked as follows: **“U.S. GOODS BEING RETURNED FOR REPAIR OR REPLACEMENT UNDER WARRANTY COMMODITY CODE 9801:00V0”**.

PRICES

All prices effective January 1st, 2026 and are subject to change without notice.

HOURS

Monday – Friday 8:00AM to 5:30PM (Eastern Standard Time)

Saturday - By appointment only please

IMPORTANT ADDITIONAL INFORMATION

WARRANTY INFORMATION

Legendary Auto Interiors, Ltd proudly stands behind all of the products and services we offer. All Legendary manufactured sewn interior soft trim products are backed by an exclusive **Limited Lifetime Warranty** for as long as you own your car. In addition, we offer a 5-year warranty on all of our molded, die-electrically heat sealed and exterior soft trim products. Legendary Auto Interiors, Ltd also offers a huge selection of interior components, which we warranty for a maximum of 1 year in accordance with the original manufacturers product warranty. **Product Disclaimer: Normal wear from use or problems due to improper installation are excluded from any warranty.**

LEGENDARY GUARANTEE

All Legendary Auto Interiors, Ltd manufactured products are made to original specifications and are guaranteed to fit. In the event that you experience a problem with any of our products or are dissatisfied with our service, we will make every effort to resolve and correct your issue promptly and do our best to make sure that you are completely satisfied.

INTERIOR COLORS/GRAINS

Legendary Auto Interiors, Ltd offers one of the most diverse product lines available in the marketplace. We feature the correct “color matched” and “grain matching” materials for nearly all models and styles. Due to the extensive number of colors produced by Chrysler, AMC and General Motors, there are some colors, which are simply not available in reproduction form. As the demand for colors increases, we are constantly having previously unavailable colors reproduced. In the event that a vinyl or cloth is not available in reproduction form, the use of NOS material may be required. Please inquire for a current quote, as the price and availability of these NOS materials will vary. To ensure a correct color and grain match, your interior trim code may be required for verification. As color dye lots will vary, we recommend purchasing all your soft trim components at the same time to ensure an exact color match of all components throughout your interior. **Color and grain samples are available upon request at no charge.**

LEATHER INTERIORS

Legendary Auto Interiors, Ltd produces a large number of “as original” leather interiors that are color matched to the original. Special order custom leather interiors are also available upon request. Some applications may require a clean, non-faded sample to ensure the closest possible color match. Leather interior orders may require additional lead-time as well as additional costs, which will be quoted at time of your order. **Note: Due to the variable nature of real leather, minor marks and features are normal and add to the character & individuality of leather products.**

CUSTOM ORDERS

In addition to “As Original” reproduction interiors, Legendary Auto Interiors, Ltd specializes in and is proud to feature “CUSTOM” interiors servicing the Resto-Mod enthusiast. With the introduction of our new & exclusive *Legend Interiors* product, custom orders have taken on an entirely new look and have given enthusiasts almost limitless options to create a one of a kind interior. Special Order and Custom interiors require approval for all designated materials being used and a signature approval on a “Custom Order” form is also required. Once the Custom work has been approved these orders must be prepaid and are Non-Returnable, Non-Refundable and Non-Cancelable.

INSTALLATION NOTES

Since age deteriorates certain areas of seats due to wear patterns and foam breakdown, certain adjustments and foam repair may be required to complete a perfect fit installation. For this reason, we recommend having a professional automotive interior trim/upholstery shop install your new Legendary Auto Interiors, Ltd soft trim products. As the manufacturer, we know how to install our products better than anyone and we offer complete installation services for both seat upholstery and door panels. For further information, see the **INSTALLATION GUIDE** included with your seat upholstery and door panels or the installation page of this catalog.

PRODUCT DEVELOPMENT & PATTERNS NEEDED

In an effort to develop new upholstery kits, door panels and other soft trim products we work hand in hand with many of our customers who provide their original parts for product development. These items must be ORIGINAL, in fair to good condition and have not been previously repaired or replaced in any way. Our Sales Department must be contacted directly before sending your old upholstery or other soft trim products to us. Since we have no idea about the usability of your parts until we receive them in, you may initially be asked to send photos in an effort to identify the condition of your original parts. Please remember that even if you send in your parts for inspection, we may not be able to use them. **PLEASE NOTE THAT OLD UPHOLSTERY AND OTHER SOFT TRIM ITEMS CANNOT BE RETURNED TO YOU, AS THEY WILL BE DISMANTLED FOR DEVELOPMENT USE.**

MAINTENANCE

All Legendary Auto Interiors, Ltd products may be cleaned with a mild soap and warm water solution. Never scrub or use any kind of harsh pads, brushes or detergents. After cleaning with mild soap and water, lightly clean again with an industrial grade wax and grease remover. (Contact your local auto parts store) Allow surface to dry. LIGHTLY mist with the vinyl protectant of your choice. Install your new parts into your cruising machine. Sit back, enjoy the ride and drive safely!! Note: On leather upholstery applications we recommend using a high-quality mink oil, neatsfoot oil and/or wax. Hand apply, let stand 30-60 minutes and then wipe /buff clean. LIGHTLY rub your soft trim product with oil and wipe excess oil from the surface. **DO NOT USE SILICONE BASED PRODUCTS** as they will deteriorate the thread and dry out leather.

INSTALLATION SERVICES

GM, CHRYSLER & AMC SEAT UPHOLSTERY

(Includes tear down of original upholstery and installation of new upholstery)



Front Buckets Install - \$500.00/pr.
(No Headrest Covers)



Front Buckets w/ Headrest Covers Install - \$600.00/pr.



Front Split Bench Install - \$575.00/ea.



Front Split Bench w/ Headrest Covers Install - \$675.00/ea.



Rear Bench Seat Install - \$400.00/ea.



Headrest Covers Install - \$150.00/pr.

Center Armrest Install - \$150.00/ea.
(for models w/ buckets and no console)



SAVE ON COMPLETE FRONT & REAR INSTALLS!!

Front Buckets & Rear Bench Seat Install - \$750.00/set

Front Buckets w/ Headrest Covers & Rear Bench Seat Install - \$850.00/set

Front Split Bench & Rear Bench Seat Install - \$825.00/set

Front Split Bench w/ Headrest Covers & Rear Bench Seat Install - \$925.00/set

**NOTE* Basic installations DO NOT include new foam and cotton replacement or reconstruction, media blasting, painting, welding, frame straightening, polishing or trim detailing. These services are additional and available at an hourly rate. Please call for more details. 1-800-363-8804*

INSTALLATION SERVICES

GM, CHRYSLER & AMC DOOR PANELS

Basic Door Panel Installation

(Includes installation of metal rails and window weatherstrip)

*Convertible rear panel installation DOES NOT include ashtray/well covers

*Ashtray/well covers for General Motors models are available. Call for details



Front Panels (Pair Only) - \$250.00/pr.



Hardtop/Convertible Rear Panels (Pair Only) - \$250.00/pr.

Complete Front & Rear Panels (Pairs Only) - \$500.00/pr.

Deluxe Door Panel Installation

(Includes installation of metal rails, window weatherstrip, metal trim and decorative emblems)

*Convertible rear panel installation DOES NOT include ashtray/well covers

*Ashtray/well covers for General Motors models are available. Call for details



Front Panels (Pair Only) - \$400.00/pr.



Hardtop/Convertible Rear Panels (Pair Only) - \$325.00/pr.

Complete Front & Rear Panels (Pairs Only) - \$725.00/pr.

DOOR PANEL REFURBISHMENT

If we do not list your particular year/make/model vehicle, Legendary Auto Interiors, Ltd. can refurbish your panels back to original for you. The following refurbishing rates include installation of new panels (on your original metal rails), inner window weatherstripping, metal trim and decorative emblems. Please call for instructions before shipping your door panels.

Front Panels (Pair Only) - \$750.00/pr.

Hardtop/Convertible Rear Panels (Pair Only) - \$500.00/pr.

Complete 2-Door Front & Rear Panels (Pairs Only) - \$1250.00/set

Complete 4-Door Front & Rear Panels (Pairs Only) - \$1250.00/set

NOTE Custom refurbishing does not include the refinishing of metal trim and decorative emblems. We highly recommend this work is done before sending the panels.

SHIPPING/HANDLING RATE CHART

<u>Order Value \$</u>	<u>Flat Rate</u>	<u>Oversize Charges</u>	<u>Rate</u>
.01-40	\$11	OS1	\$26
41-100	\$23	OS2	\$51
101-200	*\$34	OS3	\$75
201-400	*\$43		
401-600	*\$58		
601-800	*\$78		
801-1000	*\$113		
1001-1250	*\$165		
1251-1500	*\$172		
1501-1850	*\$216		
1851-2100	*\$259		
2101-2500	*\$296		
2501-2999	*\$334		
3000-up	*\$370		

*On all orders over \$100

*NYS Customers - Sales tax will be added

*AK, HI, PR & International customers call for shipping

*Next Day, 2nd Day & 3 Day Select shipping, please call for rates

*Includes \$3.50 for insurance

Oversize Items Classification

Package Tray	OS1
Trunk Divider	OS1
Plastic Door Panels	OS1
Pre-Assembled Door Panels	OS1
2nd Gen F-Body Door Panels	OS1 
Consoles	OS1
Bucket Molded Foam	OS1
Install Kits 2-4, 12-15	OS1
Vinyl Yardage (1yd & up)	OS1

Oversize Items Classification

Molded Headliners	OS3
Molded Hood Pads	OS3
Pick Up Seat Back Kits	OS3 
GM Bench Seat Foam	OS3
E-Body Dash Pads/Caps	OS3
Trunk Packages	OS3

Oversize Items Classification

C-Body Carpet Kits	OS2
62-65 B Body Mopar Carpet Kits	OS2
64-69 Cuda Fastback Carpet Kits	OS2
66-67 Charger Fastback Carpet Kits	OS2 
Carpet Yardage	OS2
Sound Dampeners	OS2
Firewall Insulation	OS2
Convertible Glass	OS2
Install Kit 5	OS2

2026 TENTATIVE SHOWS AND DATES

Spring Carlisle
Chryslers @ Carlisle
Fall Carlisle
SEMA

Carlisle, PA
Carlisle, PA
Carlisle, PA
Las Vegas, NV

April 22 - 26, 2026
July 10 - 12, 2026
Sept 30 - Oct 4, 2026
November 3 - 6, 2026

Legendary Auto Interiors Ltd. welcomes the opportunity to support the smaller clubs' and organizations' car shows and swap meets. A variety of flyers, catalogs and gift certificates are available to clubs and organizations who sponsor shows nationwide. Please call or write for additional information. The list above is a tentative schedule subject to change without notice. Come visit us at many car shows/swap meets and see what makes a Legendary interior... truly Legendary.



Legendary
AUTO INTERIORS LTD.

Table of Contents

SEAT UPHOLSTERY & TRIM ACCESORIES 1-7

Center Armrest Hinge Washer.....	17	Upholstery (Chrysler 300).....	7-13
Seat Spring Kits.....	17	Upholstery (Dodge 440).....	3
Seatback Boards.....	17	Upholstery (Fury/Sport Fury).....	3-7
		Upholstery (Newport).....	11-13
		Upholstery (Polara).....	2-3
		Upholstery (Truck).....	14-17
		Upholstery (Van).....	14

MOLDED FOAM & FOAM ACCESORIES 18-19

Cotton Rolls.....	19
High Density Foam.....	19
Hog Ring Plier Kits.....	19
Molded Foam.....	19
Seat Upholstery Installation Kits.....	19

DOOR PANELS & TRIM ACCESORIES 21-24

Armrest Bases.....	24	Door Panels (Fury/Sport Fury).....	22-23
Armrest Pads.....	24	Door Panels (Polara).....	23
Ash Trays.....	24		
Door Panel Clips.....	24		
Vent Window Cranks.....	24		
Window Cranks.....	24		
Window Crank Screws.....	24		
Window Crank Spacers.....	24		

CARPETS, FLOORMATS & ACCESORIES 25-38

Carpet.....	29	Jute Backing.....	29
Carpet Yardage.....	29	Kick Panel Insulation.....	29
Firewall Insulation.....	29	Sound Deadener.....	29
Floormats ("Custom Vintage").....	33-36		
Floormats (Next Generation).....	37-38		

DASHES, CONSOLES, SHIFTERS & ACCESORIES 39-41

4-Speed Console Side Cover.....	40	Glove Box Liners.....	41
Console Carpet Kits.....	40	Pedal Pads.....	41
Dash Vents.....	40	Pedal Pad Bezels.....	41
Dash Vent Hose Kits.....	40	Shifter Bezels.....	40
		Shifter Boots.....	40
		Underdash Insulation.....	40

Table of Contents

HEADLINERS & TRIM ACCESORIES 43-48

Courtesy Light Lenses.....	46
Dome Light Lens	45
Headliners	45
Headliner Bow Retaining Clips.....	45
Headliner Insulation.....	45
Rear Window Trim.....	46
Sail Panels.....	46
Sunvisors.....	48
Sunvisor Tips.....	48

PACKAGE TRAY & TRUNK ACCESORIES 50-55

Package Trays & Jute Insulation	52
Spare Tire Cover	54
Trunk Dividers & Insulation.....	55
Trunk Floor Filler Boards	55
Trunk Mats.....	54
Trunk Mat Material.....	54
Trunk Side Panel Covers.....	55

VINYL TOPS, CONVERTIBLE TOPS & TRIM 57-67

Convertible Body Screw Studs.....	67
Convertible Boots	66
Convertible Tops.....	63
Convertible Top Latch.....	67
Convertible Top Pads	63
Convertible Well Liners.....	67
Vinyl Tops	60

WEATHERSTRIPPING & ACCESORIES 69-73

Body Bumper Kits.....	70	Header Seals.....	72	Rear Window Gaskets.....	71
Body Plug Kits	70	Hood Bumper	70	Roof Rail Weatherstripping.....	71
Conv. Top Frame Weatherstripping	72	Hood Bumper Kits	70	Trunk Bumper Kits.....	70
Door & Trunk Lock Gaskets.....	70	Hood Pad Clips.....	72	Trunk Seals	71
Door Windlace Weatherstripping.....	71	Hood Pad Insulation	72	Vent Channel Weatherstripping.....	71
Door Weatherstripping Clips.....	71	Hood-to-Cowl Seals.....	72	Vent Window Seal	71
		Hood-to-Radiator Seals.....	72	Window Sweep Kits.....	73
		Molded Hood Pad.....	72	Window Trim Clips.....	70
				Windshield Gaskets.....	70



WE'RE NOT JUST CHRYSLER ANYMORE!

1964-72 CHEVELLE/EL CAMINO, GTO/LEMANS, CUTLASS/442 & SKYLARK/GS
1970-72 MONTE CARLO, 1970-72 NOVA & 1967-81 CAMARO & FIREBIRD

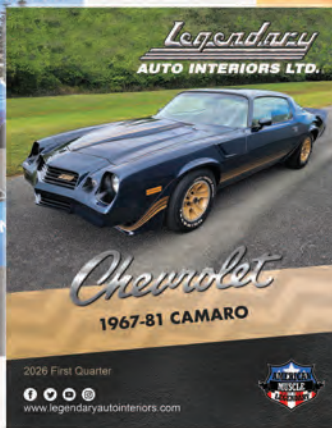
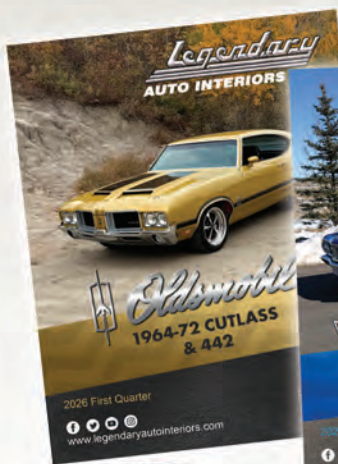



WWW.LEGENDARYAUTOINTERIORS.COM

Legendary Auto Interiors, Ltd.
121 West Shore Blvd
Newark, NY 14513

We're Social!

 facebook.com/legendaryautointeriors

 youtube.com/user/legendaryauto

 x.com/legendaryautoin

 instagram.com/legendaryautointeriorsltd



LEGENDARY AUTO INTERIORS
1-800-363-8804
WWW.LEGENDARYAUTOINTERIORS.COM